

# EPSON

## Paper Roll Printers

*ESC/POS® Application  
Programming Guide*

*Ver. 10.05*

**Printers & Commands**

**ESC/POS Information**

**Character Code Tables**

**Confidentiality Agreement**

**What's New In This Version?**

**How to Use This Guide**

**About This Guide**

# EPSON

## printers & commands

- **Commands in Alphanumeric Order**
- **Commands Arranged by Function**
- **Commands Arranged by Printer**

---

TM-T88IV supported commands

TM-T90 supported commands

TM-L90 supported commands

TM-J2000/J2100 supported commands

TM-U220 supported commands

TM-U230 supported commands

TM-P60 supported commands

# EPSON

## how to use this guide

**blue  
text**

### **Text**

Any text colored blue is a link to another screen. Click the text to go to that topic.

**PRINTER  
name**

### **Printer information**

Most information applies to all printers in a category. If there is information specific to one printer, you see its name in colored text, with a different color for each printer. The model dependent information appears if you click on the name of the printer or look at the bottom of the screen for text in the appropriate color.

# EPSON

## what's new in this version?

### **Version 10.00**

TM-U220 added.

This guide (Paper Roll Printers) is now separate from the guides for other types of printers.

### **Version 10.01**

TM-P60 added.

### **Version 10.02**

TM-L90 with Peeler added.

### **Version 10.03**

TM-P60 Bluetooth Interface Model added.

### **Version 10.04**

TM-P60 with Peeler added.

### **Version 10.05**

TM-T88IV and TM-T70 added.

# EPSON

## about this guide

ESC/POS® Application Programming Guide for Paper Roll Printers  
Version 10.05  
Seiko Epson Corporation, Imaging Products Marketing Division

Notice: The contents of this manual  
are subject to change without notice

EPSON and ESC/POS are registered trademarks of Seiko Epson Corporation.  
Adobe, Acrobat, and Reader are either registered trademarks or trademarks  
of Adobe Systems Incorporated in the United States and/or other countries.

# EPSON

## confidentiality agreement

**BY USING THIS DOCUMENT, YOU AGREE TO ABIDE BY THE TERMS OF THIS AGREEMENT. PLEASE RETURN THIS DOCUMENT IMMEDIATELY IF YOU DO NOT AGREE TO THESE TERMS.**

This document contains confidential, proprietary information of Seiko Epson Corporation or its affiliates. You must keep such information confidential. If the user is a business entity or organization, you must limit disclosure to those of your employees, agents and contractors who have a need to know and who are also bound by obligations of confidentiality.

On the earlier of (a) termination of your relationship with Seiko Epson, or (b) Seiko Epson's request, you must stop using the confidential information. You must then return or destroy the information, as directed by Seiko Epson.

If a court, arbitrator, government agency or the like orders you to disclose any confidential information, you must immediately notify Seiko Epson. You agree to give Seiko Epson reasonable cooperation and assistance in resisting disclosure.

You may use confidential information only for the purpose of facilitating authorized sales and service of, or developing software and similar products for authorized use with, EPSON products. Any other use requires the prior written consent of Seiko Epson.

THE INFORMATION IN THIS DOCUMENT IS PROVIDED "AS IS," WITHOUT WARRANTY OF ANY KIND, INCLUDING ANY WARRANTY OF TITLE OR NONINFRINGEMENT. Seiko Epson has no liability for loss or damage arising from or relating to your use of or reliance on the information in the document.

You may not reproduce, store or transmit the confidential information in any form or by any means (electronic, mechanical, photocopying, recording, or otherwise) without the prior written permission of Seiko Epson.

Your obligations under this Agreement are in addition to any other legal obligations. Seiko Epson does not waive any right under this Agreement by failing to exercise it. The laws of Japan apply to this Agreement.

## ESC/POS® PROPRIETARY COMMAND SYSTEM

The market for store automation equipment is changing rapidly with the widespread introduction of POS (point of sale) terminals. These terminals are now appearing even in small retail stores and specialty shops.

As personal computers begin to be used as POS terminals, the demand for matching uniform peripheral devices is expected to rise. At present, however, many of the competing POS terminal printers on the market employ mutually incompatible command sets. This imposes limits on the expandability and range of applications possible with PC-based systems. There is a need for a new command set designed to provide the expandability and universal applicability demanded by the market.

### ESC/POS

EPSON took the initiative by introducing ESC/POS, a proprietary POS printer command system, which includes patented or patent pending commands and enables versatile POS system construction with high scalability. Compatible with all types of EPSON POS printers and displays, this proprietary control system also offers the flexibility to easily make future upgrades. Its popularity is worldwide.

ESC/POS is designed to reduce the processing load on the host computer in POS environments. It comprises a set of highly functional and efficient commands that enables the full realization of the potential of printers.

### A command set designed for universal applicability

The commands that are supported by all EPSON POS printers and those that are specific to individual models are clearly described. This means that ESC/POS compatible software will work with any system and be suitable for a wide range of applications.

### Superb expandability allowing the addition of new functions

New functions can be added and accommodated by the categories already provided in the command system.

### Allows more effective use of software

Once a software application has been created for one printer in the TM series, it can be used as the basis for versions for the other printers in the series. Only a small portion of the program source code needs to be modified.

## COMMAND CLASSIFICATION

ESC/POS printer commands are classified by functions such as print, character, print position, printing paper, line spacing, panel button, paper sensor, mechanism control, status, bar code, bit-image, macro function, control option, and miscellaneous functions. The classification is called function classification.

ESC/POS printer commands are also classified by sheet and grade. The sheet and grade classification is called matrix classification.

The sheet classification is divided into single sheet commands and multiple sheet commands. The grade classification is separated into basic commands and extension commands.

Basic commands are defined as fundamental printer controls, including print commands and character type selection commands. Extension commands are defined as control codes for functions specific to individual printers. These commands are further divided into mechanical extension commands that relate to additional mechanical functions such as stamp and autocutter units, hardware extension commands that relate to additional hardware functions such as panel button and status transmission controls, and software extension commands that relate to additional software functions such as user-defined and bar code controls. The next screen is an overview diagram of the matrix classification of ESC/POS.



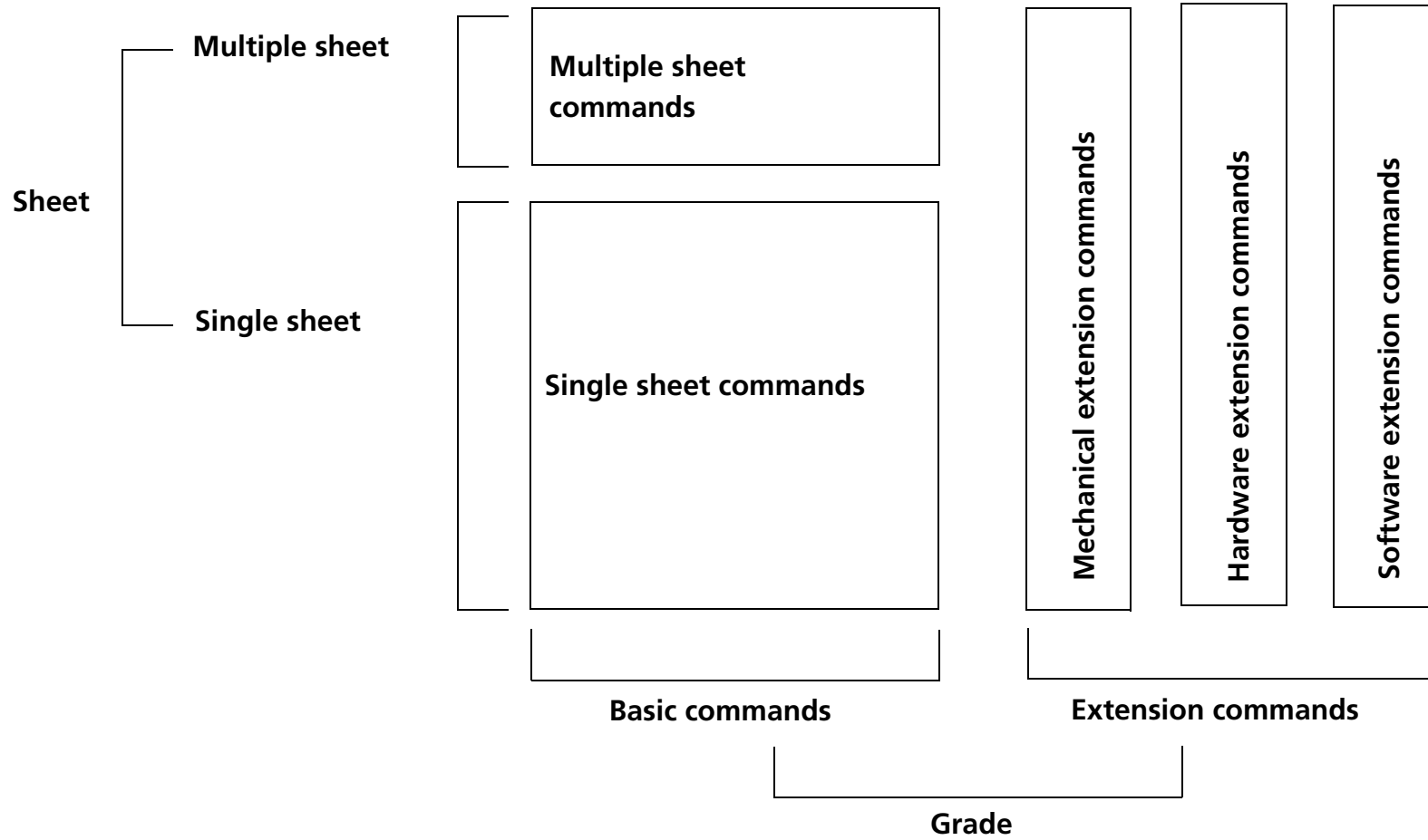

## OVERVIEW OF DATA PROCESSING

### Character Data and Normal Commands

The printer stores data sent from the host computer in the receive buffer temporarily, and then the printer interprets the data and classifies them into commands or character data sequentially. If the data from the receive buffer is a normal command, the printer processes the command corresponding to its function; for example, if the data interpreted is **ESC 3**, the printer changes a setting value for the line spacing, and if it is **LF**, the printer prints the data in the print buffer and feeds the paper one line.

If the data from the receive buffer is character data, the printer reads the appropriate font data from the resident character generator and writes image data to the print buffer.

### Real-time Commands

The printer stores data sent from the host computer in the receive buffer, interprets the data, and processes the commands corresponding to their function one line at a time. The real-time commands are the commands that consist of a **DLE** extension, such as **DLE EOT** or **DLE ENQ**. They are processed immediately. The real-time commands are ignored as undefined codes in the main processing.

## Data processing diagram

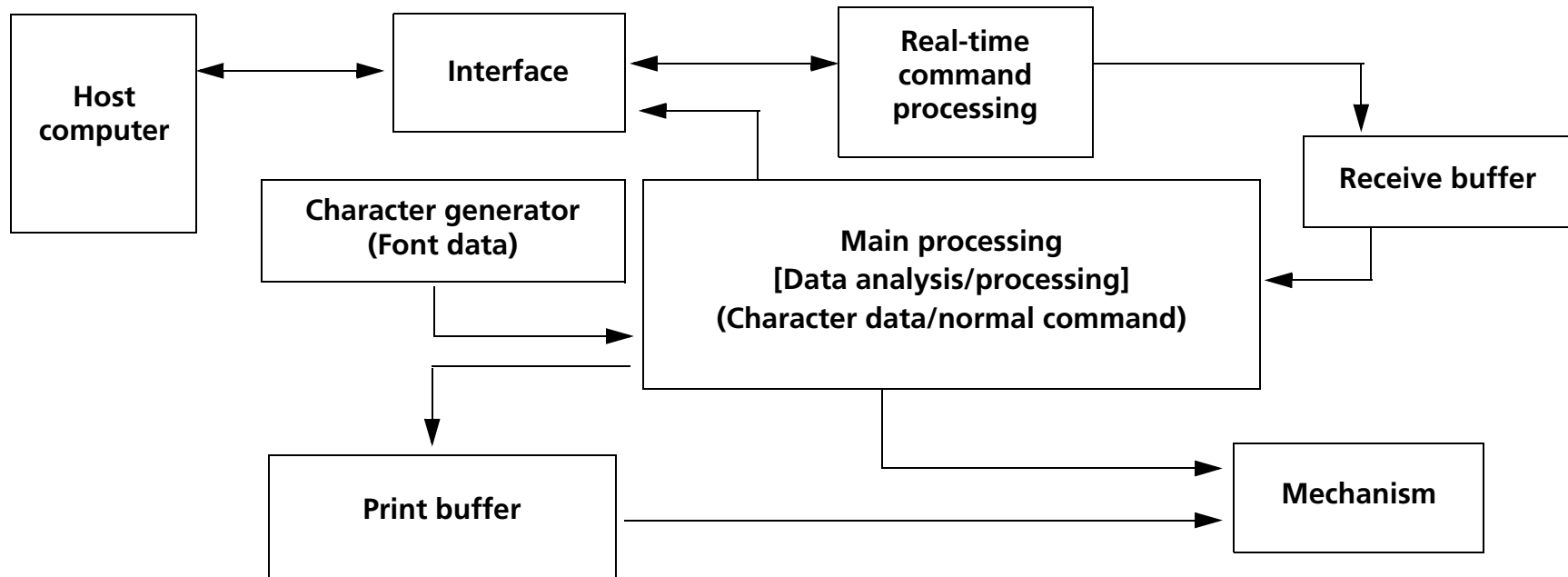

## DEFINITIONS

### **Normal commands**

Normal commands are all the commands except real-time commands. The normal commands are stored in the receive buffer temporarily and then processed sequentially.

### **Real-time commands**

Real-time commands are the commands that consist of a **DLE** extension (such as **DLE EOT** or **DLE ENQ**). The real-time commands execute processing when received. After executing, they are stored in the receive buffer and then discarded as undefined codes when the normal commands are processed.

### **Receive buffer**

The receive buffer is used to store data from the host computer. All received data is stored in this buffer and processed in the order received. Buffer capacity depends on the printer model used.

### **Obsolete commands**

These are commands that will not be supported by future printer models. The command descriptions give a better command to use for the same function.

### **Print buffer**

The print buffer is used to store image data for printing.

### **Print buffer-full**

This state occurs when the print buffer becomes full.

### **Print buffer-full printing**

If new print data (such as characters or bit images) or horizontal tabs are processed in standard mode when the print buffer is full, the image data already stored in the print buffer is printed, and a line feed is executed. This is the same operation as **LF**. The data (print data or horizontal tab) that causes the print buffer-full is processed from the beginning of the next line.

If new print data (such as characters or bit images) or horizontal tabs are processed in page mode when the print buffer is full, the printer moves the print position to the beginning of the next line (the same operation as **LF**) and processes the data (print data or horizontal tabs) that causes the print buffer-full.

## Beginning of the line

The beginning of the line meets all of the following conditions:

- No data exists in the print buffer.
- No spaces are skipped by **HT** in the print buffer.
- The print position has not been specified by **ESC \$** or **ESC \**.

In standard mode, the beginning of the line is the left margin.

## Printable area

This is the maximum printable area specified for each printer model.

This can be changed by setting the paper width with **GS ( E fn = 5** or DIP switch or setting of paper layout that is supported by the label printer model.

## Printing area

This is the printing range set by a command. The printing area should be equal to or smaller than the printable area.

In standard mode, the printing area is set by **GS L** and **GS W**, and in page mode, it is set by **ESC W**.

## Ignoring a command

This is the printer state in which the printer does nothing after receiving all codes, including parameters.

## Horizontal/vertical direction

Horizontal direction is the direction that is perpendicular to the paper feed direction. Vertical direction is the paper feed direction. In page mode, however, horizontal/vertical direction differs, depending on the print direction of a character, not the paper feed direction.

## Baseline

The baseline for character sets that are 9 dots high (for example,  $7 \times 9$  and  $9 \times 9$ ) is the invisible line marking the bottom of the character matrix (the bottom of the lowest dot possible). For other character sets, the baseline is the bottom of all characters, excluding descenders, such as the bottom parts of "g" and "y", which are below the baseline.

## Setting commands

Setting commands change printer status by processing a command and affect printer operation and print results thereafter. The commands that can specify enhanced characters, set paper feed amount, and select a character are setting commands as are some of the normal commands.

## **Executing commands**

Executing commands affect printer operation and change the printer status temporarily but do not affect the following printer operation. Functions of printing, paper cutting, and status transmission are executing commands and the real-time commands and some of the normal commands are executing commands.

## **MSB**

Most Significant Bit

## **LSB**

Least Significant Bit

## **Obsolete commands**

These are commands that will not be supported by future printer models. The description of each of these commands gives a better command to use for the same function.

## **“Reserved” bit**

“Reserved” bits are as follows:

- Bit that will be used for an extended function in the future.
- Bit that has a function in the ESC/POS specification; however, the printer does not support the function.

Use a bit with a value indicated in a table.

## **“Fixed” bit**

Use a bit only with a value indicated in a table.

## TM-T88IV SUPPORTED COMMANDS

Command	Classification	Name	Function type
<b>HT</b>	EXECUTING COMMAND	Horizontal tab	PRINT POSITION COMMANDS
<b>LF</b>	EXECUTING COMMAND	Print and line feed	PRINT COMMANDS
<b>FF (in page mode)</b>	EXECUTING COMMAND	Print and return to standard mode (in page mode)	PRINT COMMANDS
<b>CR</b>	EXECUTING COMMAND	Print and carriage return	PRINT COMMANDS
<b>CAN</b>	EXECUTING COMMAND	Cancel print data in page mode	CHARACTER COMMANDS
<b>DLE EOT</b>	EXECUTING COMMAND	Transmit real-time status	STATUS COMMANDS
<b>DLE ENQ</b>	EXECUTING COMMAND	Send real-time request to printer	MISCELLANEOUS COMMANDS
<b>DLE DC4 (fn = 1)</b>	EXECUTING COMMAND	Generate pulse in real-time	MISCELLANEOUS COMMANDS
<b>DLE DC4 (fn = 2)</b>	EXECUTING COMMAND	Execute power-off sequence	MISCELLANEOUS COMMANDS
<b>DLE DC4 (fn = 8)</b>	EXECUTING COMMAND	Clear buffer(s)	MISCELLANEOUS COMMANDS
<b>ESC FF</b>	EXECUTING COMMAND	Print data in page mode	PRINT COMMANDS
<b>ESC SP</b>	SETTING COMMAND	Set right-side character spacing	CHARACTER COMMANDS
<b>ESC !</b>	SETTING COMMAND	Select print mode(s)	CHARACTER COMMANDS
<b>ESC \$</b>	EXECUTING COMMAND	Set absolute print position	PRINT POSITION COMMANDS
<b>ESC %</b>	SETTING COMMAND	Select/cancel user-defined character set	CHARACTER COMMANDS

# CONFIDENTIAL

<b>Command</b>	<b>Classification</b>	<b>Name</b>	<b>Function type</b>
<b>ESC &amp;</b>	SETTING COMMAND	Define user-defined characters	CHARACTER COMMANDS
<b>ESC *</b>	EXECUTING COMMAND	Select bit-image mode	BIT-IMAGE COMMANDS
<b>ESC -</b>	SETTING COMMAND	Turn underline mode on/off	CHARACTER COMMANDS
<b>ESC 2</b>	SETTING COMMAND	Select default line spacing	LINE SPACING COMMANDS
<b>ESC 3</b>	SETTING COMMAND	Set line spacing	LINE SPACING COMMANDS
<b>ESC =</b>	SETTING COMMAND	Select peripheral device	MISCELLANEOUS COMMANDS
<b>ESC ?</b>	SETTING COMMAND	Cancel user-defined characters	CHARACTER COMMANDS
<b>ESC @</b>	EXECUTING + SETTING	Initialize printer	MISCELLANEOUS COMMANDS
<b>ESC D</b>	SETTING COMMAND	Set horizontal tab positions	PRINT POSITION COMMANDS
<b>ESC E</b>	SETTING COMMAND	Turn emphasized mode on/off	CHARACTER COMMANDS
<b>ESC G</b>	SETTING COMMAND	Turn double-strike mode on/off	CHARACTER COMMANDS
<b>ESC J</b>	EXECUTING COMMAND	Print and feed paper	PRINT COMMANDS
<b>ESC L</b>	EXECUTING COMMAND	Select page mode	MISCELLANEOUS COMMANDS
<b>ESC M</b>	SETTING COMMAND	Select character font	CHARACTER COMMANDS
<b>ESC R</b>	SETTING COMMAND	Select an international character set	CHARACTER COMMANDS
<b>ESC S</b>	EXECUTING COMMAND	Select standard mode	MISCELLANEOUS COMMANDS
<b>ESC T</b>	SETTING COMMAND	Select print direction in page mode	PRINT POSITION COMMANDS
<b>ESC V</b>	SETTING COMMAND	Turn 90° clockwise rotation mode on/off	CHARACTER COMMANDS



# CONFIDENTIAL

Command	Classification	Name	Function type
<b>ESC W</b>	SETTING COMMAND	Set print area in page mode	PRINT POSITION COMMANDS
<b>ESC \</b>	EXECUTING COMMAND	Set relative print position	PRINT POSITION COMMANDS
<b>ESC a</b>	SETTING COMMAND	Select justification	PRINT POSITION COMMANDS
<b>ESC c 3</b>	SETTING COMMAND	Select paper sensor(s) to output paper-end signals	PAPER SENSOR COMMANDS
<b>ESC c 4</b>	SETTING COMMAND	Select paper sensor(s) to stop printing	PAPER SENSOR COMMANDS
<b>GS !</b>	SETTING COMMAND	Select character size	CHARACTER COMMANDS
<b>ESC c 5</b>	SETTING COMMAND	Enable/disable panel buttons	PANEL BUTTON COMMAND
<b>ESC d</b>	EXECUTING COMMAND	Print and feed <b>n</b> lines	PRINT COMMANDS
<b>ESC i</b>	EXECUTING COMMAND	Partial cut (one point left uncut)	MECHANISM CONTROL COMMANDS
<b>ESC m</b>	EXECUTING COMMAND	Partial cut (three points left uncut)	MECHANISM CONTROL COMMANDS
<b>ESC p</b>	EXECUTING COMMAND	Generate pulse	MISCELLANEOUS COMMANDS
<b>ESC u</b>	SETTING COMMAND	Transmit peripheral device status	STATUS COMMANDS
<b>ESC v</b>	SETTING COMMAND	Transmit paper sensor status	STATUS COMMANDS
<b>ESC t</b>	SETTING COMMAND	Select character code table	CHARACTER COMMANDS
<b>ESC {</b>	SETTING COMMAND	Turn upside-down print mode on/off	CHARACTER COMMANDS
<b>FS g 1</b>	SETTING COMMAND	Write to NV user memory	CUSTOMIZE COMMANDS
<b>FS g 2</b>	EXECUTING COMMAND	Read from NV user memory	CUSTOMIZE COMMANDS

# CONFIDENTIAL

<b>Command</b>	<b>Classification</b>	<b>Name</b>	<b>Function type</b>
<b>FS p</b>	EXECUTING COMMAND	Print NV bit image	BIT-IMAGE COMMANDS
<b>GS ( A</b>	EXECUTING COMMAND	Execute test print	MISCELLANEOUS COMMANDS
<b>GS ( D</b>	SETTING COMMAND	Enable/disable real-time command	MISCELLANEOUS COMMANDS
<b>GS ( E</b>	EXECUTING + SETTING	Set user setup commands	CUSTOMIZE COMMANDS
<b>GS ( H</b>	EXECUTING COMMAND	Request transmission of response or status	MISCELLANEOUS COMMANDS
<b>GS ( K</b>	SETTING COMMAND	Select print control method(s)	MISCELLANEOUS COMMANDS
<b>GS ( L GS 8 L</b>	EXECUTING + SETTING	Define NV bit image	BIT-IMAGE COMMANDS
<b>GS ( N</b>	SETTING COMMAND	Select character effects	CHARACTER COMMANDS
<b>GS ( k</b>	EXECUTING + SETTING	Set up and print the symbol	BIT-IMAGE COMMANDS
<b>GS \$</b>	EXECUTING COMMAND	Set absolute vertical print position in page mode	PRINT POSITION COMMANDS
<b>GS *</b>	SETTING COMMAND	Define downloaded bit image	BIT-IMAGE COMMANDS
<b>GS /</b>	EXECUTING COMMAND	Print downloaded bit image	BIT-IMAGE COMMANDS
<b>GS :</b>	SETTING COMMAND	Start/end macro definition	MACRO FUNCTION COMMANDS
<b>GS B</b>	SETTING COMMAND	Turn white/black reverse print mode on/off	CHARACTER COMMANDS
<b>GS H</b>	SETTING COMMAND	Select print position of HRI characters	BAR CODE COMMANDS
<b>GS L</b>	SETTING COMMAND	Set left margin	PRINT POSITION COMMANDS
<b>GS P</b>	SETTING COMMAND	Set horizontal and vertical motion units	MISCELLANEOUS COMMANDS
<b>GS V</b>	EXECUTING COMMAND	Select cut mode and cut paper	MECHANISM CONTROL COMMANDS

# CONFIDENTIAL

<b>Command</b>	<b>Classification</b>	<b>Name</b>	<b>Function type</b>
<b>GS W</b>	SETTING COMMAND	Set print area width	PRINT POSITION COMMANDS
<b>GS \</b>	EXECUTING COMMAND	Set relative vertical print position in page mode	PRINT POSITION COMMANDS
<b>GS ^</b>	EXECUTING COMMAND	Execute macro	MACRO FUNCTION COMMANDS
<b>GS a</b>	EXECUTING + SETTING	Enable/disable Automatic Status Back (ASB)	STATUS COMMANDS
<b>GS b</b>	SETTING COMMAND	Turn smoothing mode on/off	CHARACTER COMMANDS
<b>GS f</b>	SETTING COMMAND	Select font for HRI characters	BAR CODE COMMANDS
<b>GS g 0</b>	SETTING COMMAND	Initialize maintenance counter	MISCELLANEOUS COMMANDS
<b>GS g 2</b>	EXECUTING COMMAND	Transmit maintenance counter	MISCELLANEOUS COMMANDS
<b>GS h</b>	SETTING COMMAND	Set bar code height	BAR CODE COMMANDS
<b>GS k</b>	EXECUTING COMMAND	Print bar code	BAR CODE COMMANDS
<b>GS r</b>	EXECUTING COMMAND	Transmit status	STATUS COMMANDS
<b>GS v 0</b>	EXECUTING COMMAND	Print raster bit image	BIT-IMAGE COMMANDS
<b>GS w</b>	SETTING COMMAND	Set bar code width	BAR CODE COMMANDS

# CONFIDENTIAL

The following commands are supported only by Japanese/Simplified Chinese/Traditional Chinese/Korean supporting models.

<b>Command</b>	<b>Classification</b>	<b>Name</b>	<b>Function type</b>
<b>FS !</b>	SETTING COMMAND	Set print mode(s) for Kanji characters	KANJI COMMANDS
<b>FS &amp;</b>	SETTING COMMAND	Select Kanji character mode	KANJI COMMANDS
<b>FS -</b>	SETTING COMMAND	Turn underline mode on/off for Kanji characters	KANJI COMMANDS
<b>FS .</b>	SETTING COMMAND	Cancel Kanji character mode	KANJI COMMANDS
<b>FS 2</b>	SETTING COMMAND	Define user-defined Kanji characters	KANJI COMMANDS
<b>FS C</b>	SETTING COMMAND	Select Kanji character code system	KANJI COMMANDS
<b>FS S</b>	SETTING COMMAND	Set Kanji character spacing	KANJI COMMANDS
<b>FS W</b>	SETTING COMMAND	Turn quadruple-size mode on/off for Kanji characters	KANJI COMMANDS

## TM-T90 SUPPORTED COMMANDS

Command	Classification	Name	Function type
<b>HT</b>	EXECUTING COMMAND	Horizontal tab	PRINT POSITION COMMANDS
<b>LF</b>	EXECUTING COMMAND	Print and line feed	PRINT COMMANDS
<b>FF (in page mode)</b>	EXECUTING COMMAND	Print and return to standard mode (in page mode)	PRINT COMMANDS
<b>CR</b>	EXECUTING COMMAND	Print and carriage return	PRINT COMMANDS
<b>CAN</b>	EXECUTING COMMAND	Cancel print data in page mode	CHARACTER COMMANDS
<b>DLE EOT</b>	EXECUTING COMMAND	Transmit real-time status	STATUS COMMANDS
<b>DLE ENQ</b>	EXECUTING COMMAND	Send real-time request to printer	MISCELLANEOUS COMMANDS
<b>DLE DC4 (fn = 1)</b>	EXECUTING COMMAND	Generate pulse in real-time	MISCELLANEOUS COMMANDS
<b>DLE DC4 (fn = 2)</b>	EXECUTING COMMAND	Execute power-off sequence	MISCELLANEOUS COMMANDS
<b>DLE DC4 (fn = 8)</b>	EXECUTING COMMAND	Clear buffer(s)	MISCELLANEOUS COMMANDS
<b>ESC FF</b>	EXECUTING COMMAND	Print data in page mode	PRINT COMMANDS
<b>ESC SP</b>	SETTING COMMAND	Set right-side character spacing	CHARACTER COMMANDS
<b>ESC !</b>	SETTING COMMAND	Select print mode(s)	CHARACTER COMMANDS
<b>ESC \$</b>	EXECUTING COMMAND	Set absolute print position	PRINT POSITION COMMANDS
<b>ESC %</b>	SETTING COMMAND	Select/cancel user-defined character set	CHARACTER COMMANDS

# CONFIDENTIAL

<b>Command</b>	<b>Classification</b>	<b>Name</b>	<b>Function type</b>
<b>ESC &amp;</b>	SETTING COMMAND	Define user-defined characters	CHARACTER COMMANDS
<b>ESC *</b>	EXECUTING COMMAND	Select bit-image mode	BIT-IMAGE COMMANDS
<b>ESC -</b>	SETTING COMMAND	Turn underline mode on/off	CHARACTER COMMANDS
<b>ESC 2</b>	SETTING COMMAND	Select default line spacing	LINE SPACING COMMANDS
<b>ESC 3</b>	SETTING COMMAND	Set line spacing	LINE SPACING COMMANDS
<b>ESC =</b>	SETTING COMMAND	Select peripheral device	MISCELLANEOUS COMMANDS
<b>ESC ?</b>	SETTING COMMAND	Cancel user-defined characters	CHARACTER COMMANDS
<b>ESC @</b>	EXECUTING + SETTING	Initialize printer	MISCELLANEOUS COMMANDS
<b>ESC D</b>	SETTING COMMAND	Set horizontal tab positions	PRINT POSITION COMMANDS
<b>ESC E</b>	SETTING COMMAND	Turn emphasized mode on/off	CHARACTER COMMANDS
<b>ESC G</b>	SETTING COMMAND	Turn double-strike mode on/off	CHARACTER COMMANDS
<b>ESC J</b>	EXECUTING COMMAND	Print and feed paper	PRINT COMMANDS
<b>ESC L</b>	EXECUTING COMMAND	Select page mode	MISCELLANEOUS COMMANDS
<b>ESC M</b>	SETTING COMMAND	Select character font	CHARACTER COMMANDS
<b>ESC R</b>	SETTING COMMAND	Select an international character set	CHARACTER COMMANDS
<b>ESC S</b>	EXECUTING COMMAND	Select standard mode	MISCELLANEOUS COMMANDS
<b>ESC T</b>	SETTING COMMAND	Select print direction in page mode	PRINT POSITION COMMANDS
<b>ESC V</b>	SETTING COMMAND	Turn 90° clockwise rotation mode on/off	CHARACTER COMMANDS

# CONFIDENTIAL

Command	Classification	Name	Function type
<b>ESC W</b>	SETTING COMMAND	Set print area in page mode	PRINT POSITION COMMANDS
<b>ESC \</b>	EXECUTING COMMAND	Set relative print position	PRINT POSITION COMMANDS
<b>ESC a</b>	SETTING COMMAND	Select justification	PRINT POSITION COMMANDS
<b>ESC c 3</b>	SETTING COMMAND	Select paper sensor(s) to output paper-end signals	PAPER SENSOR COMMANDS
<b>ESC c 4</b>	SETTING COMMAND	Select paper sensor(s) to stop printing	PAPER SENSOR COMMANDS
<b>ESC c 5</b>	SETTING COMMAND	Enable/disable panel buttons	PANEL BUTTON COMMAND
<b>ESC d</b>	EXECUTING COMMAND	Print and feed <b>n</b> lines	PRINT COMMANDS
<b>ESC p</b>	EXECUTING COMMAND	Generate pulse	MISCELLANEOUS COMMANDS
<b>ESC t</b>	SETTING COMMAND	Select character code table	CHARACTER COMMANDS
<b>ESC {</b>	SETTING COMMAND	Turn upside-down print mode on/off	CHARACTER COMMANDS
<b>FS p</b>	EXECUTING COMMAND	Print NV bit image	BIT-IMAGE COMMANDS
<b>GS ( L GS 8 L</b>	EXECUTING + SETTING	Define NV bit image	BIT-IMAGE COMMANDS
<b>GS !</b>	SETTING COMMAND	Select character size	CHARACTER COMMANDS
<b>GS \$</b>	EXECUTING COMMAND	Set absolute vertical print position in page mode	PRINT POSITION COMMANDS
<b>GS ( A</b>	EXECUTING COMMAND	Execute test print	MISCELLANEOUS COMMANDS
<b>GS ( C</b>	EXECUTING + SETTING	Edit NV user memory	CUSTOMIZE COMMANDS
<b>GS ( D</b>	SETTING COMMAND	Enable/disable real-time command	MISCELLANEOUS COMMANDS

# CONFIDENTIAL

<b>Command</b>	<b>Classification</b>	<b>Name</b>	<b>Function type</b>
<b>GS ( E</b>	EXECUTING + SETTING	Set user setup commands	CUSTOMIZE COMMANDS
<b>GS ( H</b>	EXECUTING COMMAND	Request transmission of response or status	MISCELLANEOUS COMMANDS
<b>GS ( K</b>	SETTING COMMAND	Select print control method(s)	MISCELLANEOUS COMMANDS
<b>GS ( L GS 8 L</b>	EXECUTING + SETTING	Set graphics data	BIT-IMAGE COMMANDS
<b>GS ( M</b>	SETTING COMMAND	Customize printer control value(s)	CUSTOMIZE COMMANDS
<b>GS ( N</b>	SETTING COMMAND	Select character effects	CHARACTER COMMANDS
<b>GS ( k</b>	EXECUTING + SETTING	Set up and print the symbol	BIT-IMAGE COMMANDS
<b>GS *</b>	SETTING COMMAND	Define downloaded bit image	BIT-IMAGE COMMANDS
<b>GS /</b>	EXECUTING COMMAND	Print downloaded bit image	BIT-IMAGE COMMANDS
<b>GS :</b>	SETTING COMMAND	Start/end macro definition	MACRO FUNCTION COMMANDS
<b>GS B</b>	SETTING COMMAND	Turn white/black reverse print mode on/off	CHARACTER COMMANDS
<b>GS H</b>	SETTING COMMAND	Select print position of HRI characters	BAR CODE COMMANDS
<b>GS I</b>	EXECUTING COMMAND	Transmit printer ID	MISCELLANEOUS COMMANDS
<b>GS L</b>	SETTING COMMAND	Set left margin	PRINT POSITION COMMANDS
<b>GS P</b>	SETTING COMMAND	Set horizontal and vertical motion units	MISCELLANEOUS COMMANDS
<b>GS T</b>	EXECUTING COMMAND	Set print position to the beginning of print line	PRINT POSITION COMMANDS
<b>GS V</b>	EXECUTING COMMAND	Select cut mode and cut paper	MECHANISM CONTROL COMMANDS
<b>GS W</b>	SETTING COMMAND	Set print area width	PRINT POSITION COMMANDS



# CONFIDENTIAL

<b>Command</b>	<b>Classification</b>	<b>Name</b>	<b>Function type</b>
<b>GS \</b>	EXECUTING COMMAND	Set relative vertical print position in page mode	PRINT POSITION COMMANDS
<b>GS ^</b>	EXECUTING COMMAND	Execute macro	MACRO FUNCTION COMMANDS
<b>GS a</b>	EXECUTING + SETTING	Enable/disable Automatic Status Back (ASB)	STATUS COMMANDS
<b>GS b</b>	SETTING COMMAND	Turn smoothing mode on/off	CHARACTER COMMANDS
<b>GS f</b>	SETTING COMMAND	Select font for HRI characters	BAR CODE COMMANDS
<b>GS g 0</b>	SETTING COMMAND	Initialize maintenance counter	MISCELLANEOUS COMMANDS
<b>GS g 2</b>	EXECUTING COMMAND	Transmit maintenance counter	MISCELLANEOUS COMMANDS
<b>GS h</b>	SETTING COMMAND	Set bar code height	BAR CODE COMMANDS
<b>GS k</b>	EXECUTING COMMAND	Print bar code	BAR CODE COMMANDS
<b>GS r</b>	EXECUTING COMMAND	Transmit status	STATUS COMMANDS
<b>GS v 0</b>	EXECUTING COMMAND	Print raster bit image	BIT-IMAGE COMMANDS
<b>GS w</b>	SETTING COMMAND	Set bar code width	BAR CODE COMMANDS

# CONFIDENTIAL

The following commands are supported only by Japanese/Simplified Chinese/Traditional Chinese/Korean supporting models.

<b>Command</b>	<b>Classification</b>	<b>Name</b>	<b>Function type</b>
<b>FS !</b>	SETTING COMMAND	Select print mode(s) for Kanji characters	KANJI COMMANDS
<b>FS &amp;</b>	SETTING COMMAND	Select Kanji character mode	KANJI COMMANDS
<b>FS ( A</b>	SETTING COMMAND	Define character effects of Kanji characters.	KANJI COMMANDS
<b>FS -</b>	SETTING COMMAND	Turn underline mode on/off for Kanji characters	KANJI COMMANDS
<b>FS .</b>	SETTING COMMAND	Cancel Kanji character mode	KANJI COMMANDS
<b>FS 2</b>	SETTING COMMAND	Define user-defined Kanji characters	KANJI COMMANDS
<b>FS C</b>	SETTING COMMAND	Select Kanji character code system	KANJI COMMANDS
<b>FS S</b>	SETTING COMMAND	Set Kanji character spacing	KANJI COMMANDS
<b>FS W</b>	SETTING COMMAND	Turn quadruple-size mode on/off for Kanji characters	KANJI COMMANDS

## TM-T70 SUPPORTED COMMANDS

Command	Classification	Name	Function type
<b>HT</b>	EXECUTING COMMAND	Horizontal tab	PRINT POSITION COMMANDS
<b>LF</b>	EXECUTING COMMAND	Print and line feed	PRINT COMMANDS
<b>FF (in page mode)</b>	EXECUTING COMMAND	Print and return to standard mode	PRINT COMMANDS
<b>CR</b>	EXECUTING COMMAND	Print and carriage return	PRINT COMMANDS
<b>CAN</b>	EXECUTING COMMAND	Cancel print data in page mode	CHARACTER COMMANDS
<b>DLE EOT</b>	EXECUTING COMMAND	Real-time status transmission	STATUS COMMANDS
<b>DLE ENQ</b>	EXECUTING COMMAND	Real-time request to printer	MISCELLANEOUS COMMANDS
<b>DLE DC4 (fn = 1)</b>	EXECUTING COMMAND	Generate pulse at real-time	MISCELLANEOUS COMMANDS
<b>DLE DC4 (fn = 2)</b>	EXECUTING COMMAND	Turn off the power	MISCELLANEOUS COMMANDS
<b>DLE DC4 (fn = 8)</b>	EXECUTING COMMAND	Clear buffer	MISCELLANEOUS COMMANDS
<b>ESC FF</b>	EXECUTING COMMAND	Print data in page mode	PRINT COMMANDS
<b>ESC SP</b>	SETTING COMMAND	Set right-side character spacing	CHARACTER COMMANDS
<b>ESC !</b>	SETTING COMMAND	Select print mode(s)	CHARACTER COMMANDS
<b>ESC \$</b>	EXECUTING COMMAND	Set absolute print position	PRINT POSITION COMMANDS
<b>ESC %</b>	SETTING COMMAND	Select/cancel user-defined character set	CHARACTER COMMANDS
<b>ESC &amp;</b>	SETTING COMMAND	Define user-defined characters	CHARACTER COMMANDS

# CONFIDENTIAL

<b>Command</b>	<b>Classification</b>	<b>Name</b>	<b>Function type</b>
<b>ESC *</b>	EXECUTING COMMAND	Select bit-image mode	BIT-IMAGE COMMANDS
<b>ESC -</b>	SETTING COMMAND	Turn underline mode on/off	CHARACTER COMMANDS
<b>ESC 2</b>	SETTING COMMAND	Select default line spacing	LINE SPACING COMMANDS
<b>ESC 3</b>	SETTING COMMAND	Set line spacing	LINE SPACING COMMANDS
<b>ESC =</b>	SETTING COMMAND	Select peripheral device	MISCELLANEOUS COMMANDS
<b>ESC ?</b>	SETTING COMMAND	Cancel user-defined characters	CHARACTER COMMANDS
<b>ESC @</b>	EXECUTING + SETTING	Initialize printer	MISCELLANEOUS COMMANDS
<b>ESC D</b>	SETTING COMMAND	Set horizontal tab positions	PRINT POSITION COMMANDS
<b>ESC E</b>	SETTING COMMAND	Turn emphasized mode on/off	CHARACTER COMMANDS
<b>ESC G</b>	SETTING COMMAND	Turn double-strike mode on/off	CHARACTER COMMANDS
<b>ESC J</b>	EXECUTING COMMAND	Print and feed paper	PRINT COMMANDS
<b>ESC L</b>	EXECUTING COMMAND	Select page mode	MISCELLANEOUS COMMANDS
<b>ESC R</b>	SETTING COMMAND	Select an international character set	CHARACTER COMMANDS
<b>ESC S</b>	EXECUTING COMMAND	Select standard mode	MISCELLANEOUS COMMANDS
<b>ESC T</b>	SETTING COMMAND	Select print direction in page mode	PRINT POSITION COMMANDS
<b>ESC W</b>	SETTING COMMAND	Set printing area in page mode	PRINT POSITION COMMANDS
<b>ESC \</b>	EXECUTING COMMAND	Set relative print position	PRINT POSITION COMMANDS
<b>ESC a</b>	SETTING COMMAND	Select justification	PRINT POSITION COMMANDS

# CONFIDENTIAL

Command	Classification	Name	Function type
<b>ESC c 3</b>	SETTING COMMAND	Select paper sensor(s) to output paper-end signals	PAPER SENSOR COMMANDS
<b>ESC c 4</b>	SETTING COMMAND	Select paper sensor(s) to stop printing	PAPER SENSOR COMMANDS
<b>ESC c 5</b>	SETTING COMMAND	Enable/disable panel buttons	PANEL BUTTON COMMAND
<b>ESC d</b>	EXECUTING COMMAND	Print and feed <b>n</b> lines	PRINT COMMANDS
<b>ESC p</b>	EXECUTING COMMAND	Generate pulse	MISCELLANEOUS COMMANDS
<b>ESC t</b>	SETTING COMMAND	Select character code table	CHARACTER COMMANDS
<b>ESC {</b>	SETTING COMMAND	Turn upside-down printing mode on/off	CHARACTER COMMANDS
<b>FS !</b>	SETTING COMMAND	Set print mode(s) for Kanji characters	KANJI COMMANDS
<b>FS &amp;</b>	SETTING COMMAND	Select Kanji character mode	KANJI COMMANDS
<b>FS ( A</b>	SETTING COMMAND	Define character effects of Kanji characters.	KANJI COMMANDS
<b>FS -</b>	SETTING COMMAND	Turn underline mode on/off for Kanji characters	KANJI COMMANDS
<b>FS .</b>	SETTING COMMAND	Cancel Kanji character mode	KANJI COMMANDS
<b>FS 2</b>	SETTING COMMAND	Define user-defined Kanji characters	KANJI COMMANDS
<b>FS C</b>	SETTING COMMAND	Select Kanji character code system	KANJI COMMANDS
<b>FS S</b>	SETTING COMMAND	Set Kanji character spacing	KANJI COMMANDS
<b>FS W</b>	SETTING COMMAND	Turn quadruple-size mode on/off for Kanji characters	KANJI COMMANDS
<b>GS !</b>	SETTING COMMAND	Select character size	CHARACTER COMMANDS

# CONFIDENTIAL

<b>Command</b>	<b>Classification</b>	<b>Name</b>	<b>Function type</b>
<b>GS \$</b>	SETTING COMMAND	Set absolute vertical print position in page mode	PRINT POSITION COMMANDS
<b>GS ( A</b>	EXECUTING COMMAND	Execute test print	MISCELLANEOUS COMMANDS
<b>GS ( C</b>	EXECUTING + SETTING	Edit NV user memory	CUSTOMIZE COMMANDS
<b>GS ( D</b>	SETTING COMMAND	Enable/disable real-time command	MISCELLANEOUS COMMANDS
<b>GS ( E</b>	EXECUTING + SETTING	User setup commands	CUSTOMIZE COMMANDS
<b>GS ( K</b>	SETTING COMMAND	Select printing control	MISCELLANEOUS COMMANDS
<b>GS ( L GS 8 L</b>	EXECUTING + SETTING	Specify graphics data	BIT-IMAGE COMMANDS
<b>GS ( k</b>	EXECUTING + SETTING	Specify and print the symbol	TWO DIMENSION CODE COMMANDS
<b>GS *</b>	SETTING COMMAND	Define downloaded bit image	BIT-IMAGE COMMANDS
<b>GS /</b>	EXECUTING COMMAND	Print downloaded bit image	BIT-IMAGE COMMANDS
<b>GS :</b>	SETTING COMMAND	Start/end macro definition	MACRO FUNCTION COMMANDS
<b>GS B</b>	SETTING COMMAND	Turn white/black reverse printing mode on/off	CHARACTER COMMANDS
<b>GS H</b>	SETTING COMMAND	Select printing position of HRI characters	BAR CODE COMMANDS
<b>GS I</b>	EXECUTING COMMAND	Transmit printer ID	MISCELLANEOUS COMMANDS
<b>GS L</b>	SETTING COMMAND	Set left margin	PRINT POSITION COMMANDS
<b>GS P</b>	SETTING COMMAND	Set horizontal and vertical motion units	MISCELLANEOUS COMMANDS
<b>GS V</b>	EXECUTING COMMAND	Select cut mode and cut paper	MECHANISM CONTROL COMMANDS
<b>GS W</b>	SETTING COMMAND	Set printing area width	PRINT POSITION COMMANDS

# CONFIDENTIAL

<b>Command</b>	<b>Classification</b>	<b>Name</b>	<b>Function type</b>
<b>GS \</b>	EXECUTING COMMAND	Set relative vertical print position in page mode	PRINT POSITION COMMANDS
<b>GS a</b>	EXECUTING + SETTING	Enable/disable Automatic Status Back (ASB)	STATUS COMMANDS
<b>GS b</b>	SETTING COMMAND	Turn smoothing mode on/off	CHARACTER COMMANDS
<b>GS f</b>	SETTING COMMAND	Select font for HRI characters	BAR CODE COMMANDS
<b>GS g 0</b>	SETTING COMMAND	Initialize maintenance counter	MISCELLANEOUS COMMANDS
<b>GS g 2</b>	EXECUTING COMMAND	Transmit maintenance counter	MISCELLANEOUS COMMANDS
<b>GS h</b>	SETTING COMMAND	Set bar code height	BAR CODE COMMANDS
<b>GS k</b>	EXECUTING COMMAND	Print bar code	BAR CODE COMMANDS
<b>GS r</b>	EXECUTING COMMAND	Transmit status	STATUS COMMANDS
<b>GS w</b>	SETTING COMMAND	Set bar code width	BAR CODE COMMANDS

## TM-L90 SUPPORTED COMMANDS

Command	Classification	Name	Function type
<b>HT</b>	EXECUTING COMMAND	Horizontal tab	PRINT POSITION COMMANDS
<b>LF</b>	EXECUTING COMMAND	Print and line feed	PRINT COMMANDS
<b>FF (in page mode)</b>	EXECUTING COMMAND	Print and return to standard mode (in page mode)	PRINT COMMANDS
<b>CR</b>	EXECUTING COMMAND	Print and carriage return	PRINT COMMANDS
<b>CAN</b>	EXECUTING COMMAND	Cancel print data in page mode	CHARACTER COMMANDS
<b>DLE EOT</b>	EXECUTING COMMAND	Transmit real-time status	STATUS COMMANDS
<b>DLE ENQ</b>	EXECUTING COMMAND	Send real-time request to printer	MISCELLANEOUS COMMANDS
<b>DLE DC4 (fn = 1)</b>	EXECUTING COMMAND	Generate pulse in real-time	MISCELLANEOUS COMMANDS
<b>DLE DC4 (fn = 2)</b>	EXECUTING COMMAND	Execute power-off sequence	MISCELLANEOUS COMMANDS
<b>DLE DC4 (fn = 8)</b>	EXECUTING COMMAND	Clear buffer(s)	MISCELLANEOUS COMMANDS
<b>ESC FF</b>	EXECUTING COMMAND	Print data in page mode	PRINT COMMANDS
<b>ESC SP</b>	SETTING COMMAND	Set right-side character spacing	CHARACTER COMMANDS
<b>ESC !</b>	SETTING COMMAND	Select print mode(s)	CHARACTER COMMANDS
<b>ESC \$</b>	EXECUTING COMMAND	Set absolute print position	PRINT POSITION COMMANDS
<b>ESC %</b>	SETTING COMMAND	Select/cancel user-defined character set	CHARACTER COMMANDS



# CONFIDENTIAL

<b>Command</b>	<b>Classification</b>	<b>Name</b>	<b>Function type</b>
<b>ESC &amp;</b>	SETTING COMMAND	Define user-defined characters	CHARACTER COMMANDS
<b>ESC *</b>	EXECUTING COMMAND	Select bit-image mode	BIT-IMAGE COMMANDS
<b>ESC -</b>	SETTING COMMAND	Turn underline mode on/off	CHARACTER COMMANDS
<b>ESC 2</b>	SETTING COMMAND	Select default line spacing	LINE SPACING COMMANDS
<b>ESC 3</b>	SETTING COMMAND	Set line spacing	LINE SPACING COMMANDS
<b>ESC =</b>	SETTING COMMAND	Select peripheral device	MISCELLANEOUS COMMANDS
<b>ESC ?</b>	SETTING COMMAND	Cancel user-defined characters	CHARACTER COMMANDS
<b>ESC @</b>	EXECUTING + SETTING	Initialize printer	MISCELLANEOUS COMMANDS
<b>ESC D</b>	SETTING COMMAND	Set horizontal tab positions	PRINT POSITION COMMANDS
<b>ESC E</b>	SETTING COMMAND	Turn emphasized mode on/off	CHARACTER COMMANDS
<b>ESC G</b>	SETTING COMMAND	Turn double-strike mode on/off	CHARACTER COMMANDS
<b>ESC J</b>	EXECUTING COMMAND	Print and feed paper	PRINT COMMANDS
<b>ESC L</b>	EXECUTING COMMAND	Select page mode	MISCELLANEOUS COMMANDS
<b>ESC M</b>	SETTING COMMAND	Select character font	CHARACTER COMMANDS
<b>ESC R</b>	SETTING COMMAND	Select an international character set	CHARACTER COMMANDS
<b>ESC S</b>	EXECUTING COMMAND	Select standard mode	MISCELLANEOUS COMMANDS
<b>ESC T</b>	SETTING COMMAND	Select print direction in page mode	PRINT POSITION COMMANDS
<b>ESC V</b>	SETTING COMMAND	Turn 90° clockwise rotation mode on/off	CHARACTER COMMANDS

# CONFIDENTIAL

Command	Classification	Name	Function type
<b>ESC W</b>	SETTING COMMAND	Set print area in page mode	PRINT POSITION COMMANDS
<b>ESC \</b>	EXECUTING COMMAND	Set relative print position	PRINT POSITION COMMANDS
<b>ESC a</b>	SETTING COMMAND	Select justification	PRINT POSITION COMMANDS
<b>ESC c 3</b>	SETTING COMMAND	Select paper sensor(s) to output paper-end signals	PAPER SENSOR COMMANDS
<b>ESC c 4</b>	SETTING COMMAND	Select paper sensor(s) to stop printing	PAPER SENSOR COMMANDS
<b>ESC c 5</b>	SETTING COMMAND	Enable/disable panel buttons	PANEL BUTTON COMMAND
<b>ESC d</b>	EXECUTING COMMAND	Print and feed <b>n</b> lines	PRINT COMMANDS
<b>ESC p</b>	EXECUTING COMMAND	Generate pulse	MISCELLANEOUS COMMANDS
<b>ESC t</b>	SETTING COMMAND	Select character code table	CHARACTER COMMANDS
<b>ESC {</b>	SETTING COMMAND	Turn upside-down print mode on/off	CHARACTER COMMANDS
<b>FS ( L</b>	EXECUTING COMMAND	Select label and black mark control function(s)	PRINTING PAPER COMMANDS
<b>FS p</b>	EXECUTING COMMAND	Print NV bit image	BIT-IMAGE COMMANDS
<b>GS ( L GS 8 L</b>	EXECUTING + SETTING	Define NV bit image	BIT-IMAGE COMMANDS
<b>GS !</b>	SETTING COMMAND	Select character size	CHARACTER COMMANDS
<b>GS \$</b>	EXECUTING COMMAND	Set absolute vertical print position in page mode	PRINT POSITION COMMANDS
<b>GS ( A</b>	EXECUTING COMMAND	Execute test print	MISCELLANEOUS COMMANDS
<b>GS ( C</b>	EXECUTING + SETTING	Edit NV user memory	CUSTOMIZE COMMANDS

# CONFIDENTIAL

Command	Classification	Name	Function type
<b>GS ( D</b>	SETTING COMMAND	Enable/disable real-time command	MISCELLANEOUS COMMANDS
<b>GS ( E</b>	EXECUTING + SETTING	Set user setup commands	CUSTOMIZE COMMANDS
<b>GS ( K</b>	SETTING COMMAND	Select print control method(s)	MISCELLANEOUS COMMANDS
<b>GS ( L GS 8 L</b>	EXECUTING + SETTING	Set graphics data	BIT-IMAGE COMMANDS
<b>GS ( M</b>	SETTING COMMAND	Customize printer control value(s)	CUSTOMIZE COMMANDS
<b>GS ( N</b>	SETTING COMMAND	Select character effects	CHARACTER COMMANDS
<b>GS ( k</b>	EXECUTING + SETTING	Set up and print the symbol	BIT-IMAGE COMMANDS
<b>GS *</b>	SETTING COMMAND	Define downloaded bit image	BIT-IMAGE COMMANDS
<b>GS \</b>	EXECUTING COMMAND	Print downloaded bit image	BIT-IMAGE COMMANDS
<b>GS :</b>	SETTING COMMAND	Start/end macro definition	MACRO FUNCTION COMMANDS
<b>GS B</b>	SETTING COMMAND	Turn white/black reverse print mode on/off	CHARACTER COMMANDS
<b>GS H</b>	SETTING COMMAND	Select print position of HRI characters	BAR CODE COMMANDS
<b>GS I</b>	EXECUTING COMMAND	Transmit printer ID	MISCELLANEOUS COMMANDS
<b>GS L</b>	SETTING COMMAND	Set left margin	PRINT POSITION COMMANDS
<b>GS P</b>	SETTING COMMAND	Set horizontal and vertical motion units	MISCELLANEOUS COMMANDS
<b>GS T</b>	EXECUTING COMMAND	Set print position to the beginning of print line	PRINT POSITION COMMANDS
<b>GS V</b>	EXECUTING COMMAND	Select cut mode and cut paper	MECHANISM CONTROL COMMANDS
<b>GS W</b>	SETTING COMMAND	Set print area width	PRINT POSITION COMMANDS

# CONFIDENTIAL

<b>Command</b>	<b>Classification</b>	<b>Name</b>	<b>Function type</b>
<b>GS \</b>	EXECUTING COMMAND	Set relative vertical print position in page mode	PRINT POSITION COMMANDS
<b>GS ^</b>	EXECUTING COMMAND	Execute macro	MACRO FUNCTION COMMANDS
<b>GS a</b>	EXECUTING + SETTING	Enable/disable Automatic Status Back (ASB)	STATUS COMMANDS
<b>GS b</b>	SETTING COMMAND	Turn smoothing mode on/off	CHARACTER COMMANDS
<b>GS f</b>	SETTING COMMAND	Select font for HRI characters	BAR CODE COMMANDS
<b>GS g 0</b>	SETTING COMMAND	Initialize maintenance counter	MISCELLANEOUS COMMANDS
<b>GS g 2</b>	EXECUTING COMMAND	Transmit maintenance counter	MISCELLANEOUS COMMANDS
<b>GS h</b>	SETTING COMMAND	Set bar code height	BAR CODE COMMANDS
<b>GS k</b>	EXECUTING COMMAND	Print bar code	BAR CODE COMMANDS
<b>GS r</b>	EXECUTING COMMAND	Transmit status	STATUS COMMANDS
<b>GS v 0</b>	EXECUTING COMMAND	Print raster bit image	BIT-IMAGE COMMANDS
<b>GS w</b>	SETTING COMMAND	Set bar code width	BAR CODE COMMANDS

# CONFIDENTIAL

The following commands are supported only by Japanese/Simplified Chinese/Traditional Chinese/Korean supporting models.

<b>Command</b>	<b>Classification</b>	<b>Name</b>	<b>Function type</b>
<b>FS !</b>	SETTING COMMAND	Select print mode(s) for Kanji characters	KANJI COMMANDS
<b>FS &amp;</b>	SETTING COMMAND	Select Kanji character mode	KANJI COMMANDS
<b>FS ( A</b>	SETTING COMMAND	Define character effects of Kanji characters.	KANJI COMMANDS
<b>FS -</b>	SETTING COMMAND	Turn underline mode on/off for Kanji characters	KANJI COMMANDS
<b>FS .</b>	SETTING COMMAND	Cancel Kanji character mode	KANJI COMMANDS
<b>FS 2</b>	SETTING COMMAND	Define user-defined Kanji characters	KANJI COMMANDS
<b>FS C</b>	SETTING COMMAND	Select Kanji character code system	KANJI COMMANDS
<b>FS S</b>	SETTING COMMAND	Set Kanji character spacing	KANJI COMMANDS
<b>FS W</b>	SETTING COMMAND	Turn quadruple-size mode on/off for Kanji characters	KANJI COMMANDS

## TM-J2000/J2100 SUPPORTED COMMANDS

Command	Classification	Name	Function type
<b>HT</b>	EXECUTING COMMAND	Horizontal tab	PRINT POSITION COMMANDS
<b>LF</b>	EXECUTING COMMAND	Print and line feed	PRINT COMMANDS
<b>FF (in page mode)</b>	EXECUTING COMMAND	Print and return to standard mode (in page mode)	PRINT COMMANDS
<b>CR</b>	EXECUTING COMMAND	Print and carriage return	PRINT COMMANDS
<b>CAN</b>	EXECUTING COMMAND	Cancel print data in page mode	CHARACTER COMMANDS
<b>DLE EOT</b>	EXECUTING COMMAND	Transmit real-time status	STATUS COMMANDS
<b>DLE ENQ</b>	EXECUTING COMMAND	Send real-time request to printer	MISCELLANEOUS COMMANDS
<b>DLE DC4 (fn = 1)</b>	EXECUTING COMMAND	Generate pulse in real-time	MISCELLANEOUS COMMANDS
<b>DLE DC4 (fn = 2)</b>	EXECUTING COMMAND	Execute power-off sequence	MISCELLANEOUS COMMANDS
<b>DLE DC4 (fn = 8)</b>	EXECUTING COMMAND	Clear buffer(s)	MISCELLANEOUS COMMANDS
<b>ESC FF</b>	EXECUTING COMMAND	Print data in page mode	PRINT COMMANDS
<b>ESC SP</b>	SETTING COMMAND	Set right-side character spacing	CHARACTER COMMANDS
<b>ESC !</b>	SETTING COMMAND	Select print mode(s)	CHARACTER COMMANDS
<b>ESC \$</b>	EXECUTING COMMAND	Set absolute print position	PRINT POSITION COMMANDS
<b>ESC %</b>	SETTING COMMAND	Select/cancel user-defined character set	CHARACTER COMMANDS

# CONFIDENTIAL

<b>Command</b>	<b>Classification</b>	<b>Name</b>	<b>Function type</b>
<b>ESC &amp;</b>	SETTING COMMAND	Define user-defined characters	CHARACTER COMMANDS
<b>ESC *</b>	EXECUTING COMMAND	Select bit-image mode	BIT-IMAGE COMMANDS
<b>ESC -</b>	SETTING COMMAND	Turn underline mode on/off	CHARACTER COMMANDS
<b>ESC 2</b>	SETTING COMMAND	Select default line spacing	LINE SPACING COMMANDS
<b>ESC 3</b>	SETTING COMMAND	Set line spacing	LINE SPACING COMMANDS
<b>ESC &lt;</b>	EXECUTING COMMAND	Return home	MECHANISM CONTROL COMMANDS
<b>ESC =</b>	SETTING COMMAND	Select peripheral device	MISCELLANEOUS COMMANDS
<b>ESC ?</b>	SETTING COMMAND	Cancel user-defined characters	CHARACTER COMMANDS
<b>ESC @</b>	EXECUTING + SETTING	Initialize printer	MISCELLANEOUS COMMANDS
<b>ESC D</b>	SETTING COMMAND	Set horizontal tab positions	PRINT POSITION COMMANDS
<b>ESC E</b>	SETTING COMMAND	Turn emphasized mode on/off	CHARACTER COMMANDS
<b>ESC G</b>	SETTING COMMAND	Turn double-strike mode on/off	CHARACTER COMMANDS
<b>ESC J</b>	EXECUTING COMMAND	Print and feed paper	PRINT COMMANDS
<b>ESC L</b>	EXECUTING COMMAND	Select page mode	MISCELLANEOUS COMMANDS
<b>ESC M</b>	SETTING COMMAND	Select character font	CHARACTER COMMANDS
<b>ESC R</b>	SETTING COMMAND	Select an international character set	CHARACTER COMMANDS
<b>ESC S</b>	EXECUTING COMMAND	Select standard mode	MISCELLANEOUS COMMANDS
<b>ESC T</b>	SETTING COMMAND	Select print direction in page mode	PRINT POSITION COMMANDS

# CONFIDENTIAL

Command	Classification	Name	Function type
<b>ESC U</b>	SETTING COMMAND	Turn unidirectional print mode on/off	MECHANISM CONTROL COMMANDS
<b>ESC V</b>	SETTING COMMAND	Turn 90° clockwise rotation mode on/off	CHARACTER COMMANDS
<b>ESC W</b>	SETTING COMMAND	Set print area in page mode	PRINT POSITION COMMANDS
<b>ESC \</b>	EXECUTING COMMAND	Set relative print position	PRINT POSITION COMMANDS
<b>ESC a</b>	SETTING COMMAND	Select justification	PRINT POSITION COMMANDS
<b>ESC c 3</b>	SETTING COMMAND	Select paper sensor(s) to output paper-end signals	PAPER SENSOR COMMANDS
<b>ESC c 4</b>	SETTING COMMAND	Select paper sensor(s) to stop printing	PAPER SENSOR COMMANDS
<b>ESC c 5</b>	SETTING COMMAND	Enable/disable panel buttons	PANEL BUTTON COMMAND
<b>ESC d</b>	EXECUTING COMMAND	Print and feed <b>n</b> lines	PRINT COMMANDS
<b>ESC p</b>	EXECUTING COMMAND	Generate pulse	MISCELLANEOUS COMMANDS
<b>ESC r</b>	SETTING COMMAND	Select print color	CHARACTER COMMANDS
<b>ESC t</b>	SETTING COMMAND	Select character code table	CHARACTER COMMANDS
<b>ESC {</b>	SETTING COMMAND	Turn upside-down print mode on/off	CHARACTER COMMANDS
<b>FS p</b>	EXECUTING COMMAND	Print NV bit image	BIT-IMAGE COMMANDS
<b>GS ( L GS 8 L</b>	EXECUTING + SETTING	Define NV bit image	BIT-IMAGE COMMANDS
<b>GS !</b>	SETTING COMMAND	Select character size	CHARACTER COMMANDS
<b>GS \$</b>	EXECUTING COMMAND	Set absolute vertical print position in page mode	PRINT POSITION COMMANDS



# CONFIDENTIAL

Command	Classification	Name	Function type
<b>GS ( A</b>	EXECUTING COMMAND	Execute test print	MISCELLANEOUS COMMANDS
<b>GS ( C</b>	EXECUTING + SETTING	Edit NV user memory	CUSTOMIZE COMMANDS
<b>GS ( D</b>	SETTING COMMAND	Enable/disable real-time command	MISCELLANEOUS COMMANDS
<b>GS ( E</b>	EXECUTING + SETTING	Set user setup commands	CUSTOMIZE COMMANDS
<b>GS ( K</b>	SETTING COMMAND	Select print control method(s)	MISCELLANEOUS COMMANDS
<b>GS ( L GS 8 L</b>	EXECUTING + SETTING	Set graphics data	BIT-IMAGE COMMANDS
<b>GS ( M</b>	SETTING COMMAND	Customize printer control value(s)	CUSTOMIZE COMMANDS
<b>GS ( N</b>	SETTING COMMAND	Select character effects	CHARACTER COMMANDS
<b>GS *</b>	SETTING COMMAND	Define downloaded bit image	BIT-IMAGE COMMANDS
<b>GS \</b>	EXECUTING COMMAND	Print downloaded bit image	BIT-IMAGE COMMANDS
<b>GS :</b>	SETTING COMMAND	Start/end macro definition	MACRO FUNCTION COMMANDS
<b>GS B</b>	SETTING COMMAND	Turn white/black reverse print mode on/off	CHARACTER COMMANDS
<b>GS H</b>	SETTING COMMAND	Select print position of HRI characters	BAR CODE COMMANDS
<b>GS I</b>	EXECUTING COMMAND	Transmit printer ID	MISCELLANEOUS COMMANDS
<b>GS L</b>	SETTING COMMAND	Set left margin	PRINT POSITION COMMANDS
<b>GS P</b>	SETTING COMMAND	Set horizontal and vertical motion units	MISCELLANEOUS COMMANDS
<b>GS Q 0</b>	EXECUTING COMMAND	Print variable vertical size bit image	BIT-IMAGE COMMANDS
<b>GS T</b>	EXECUTING COMMAND	Set print position to the beginning of print line	PRINT POSITION COMMANDS

# CONFIDENTIAL

<b>Command</b>	<b>Classification</b>	<b>Name</b>	<b>Function type</b>
<b>GS V</b>	EXECUTING COMMAND	Select cut mode and cut paper	MECHANISM CONTROL COMMANDS
<b>GS W</b>	SETTING COMMAND	Set print area width	PRINT POSITION COMMANDS
<b>GS \</b>	EXECUTING COMMAND	Set relative vertical print position in page mode	PRINT POSITION COMMANDS
<b>GS ^</b>	EXECUTING COMMAND	Execute macro	MACRO FUNCTION COMMANDS
<b>GS a</b>	EXECUTING + SETTING	Enable/disable Automatic Status Back (ASB)	STATUS COMMANDS
<b>GS b</b>	SETTING COMMAND	Turn smoothing mode on/off	CHARACTER COMMANDS
<b>GS f</b>	SETTING COMMAND	Select font for HRI characters	BAR CODE COMMANDS
<b>GS g 0</b>	SETTING COMMAND	Initialize maintenance counter	MISCELLANEOUS COMMANDS
<b>GS g 2</b>	EXECUTING COMMAND	Transmit maintenance counter	MISCELLANEOUS COMMANDS
<b>GS h</b>	SETTING COMMAND	Set bar code height	BAR CODE COMMANDS
<b>GS j</b>	EXECUTING + SETTING	Enable/disable Automatic Status Back (ASB) for ink	STATUS COMMANDS
<b>GS k</b>	EXECUTING COMMAND	Print bar code	BAR CODE COMMANDS
<b>GS r</b>	EXECUTING COMMAND	Transmit status	STATUS COMMANDS
<b>GS v 0</b>	EXECUTING COMMAND	Print raster bit image	BIT-IMAGE COMMANDS
<b>GS w</b>	SETTING COMMAND	Set bar code width	BAR CODE COMMANDS

# CONFIDENTIAL

The following commands are supported only by Japanese/Simplified Chinese/Traditional Chinese/Korean supporting models.

<b>Command</b>	<b>Classification</b>	<b>Name</b>	<b>Function type</b>
<b>FS !</b>	SETTING COMMAND	Select print mode(s) for Kanji characters	KANJI COMMANDS
<b>FS &amp;</b>	SETTING COMMAND	Select Kanji character mode	KANJI COMMANDS
<b>FS ( A</b>	SETTING COMMAND	Select Kanji character style(s)	KANJI COMMANDS
<b>FS -</b>	SETTING COMMAND	Turn underline mode on/off for Kanji characters	KANJI COMMANDS
<b>FS .</b>	SETTING COMMAND	Cancel Kanji character mode	KANJI COMMANDS
<b>FS 2</b>	SETTING COMMAND	Define user-defined Kanji characters	KANJI COMMANDS
<b>FS C</b>	SETTING COMMAND	Select Kanji character code system	KANJI COMMANDS
<b>FS S</b>	SETTING COMMAND	Set Kanji character spacing	KANJI COMMANDS
<b>FS W</b>	SETTING COMMAND	Turn quadruple-size mode on/off for Kanji characters	KANJI COMMANDS
<b>FS ?</b>	SETTING COMMAND	Cancel user-defined Kanji characters	KANJI COMMANDS

## TM-U220 SUPPORTED COMMANDS

Command	Classification	Name	Function type
<b>HT</b>	EXECUTING COMMAND	Horizontal tab	PRINT POSITION COMMANDS
<b>LF</b>	EXECUTING COMMAND	Print and line feed	PRINT COMMANDS
<b>CR</b>	EXECUTING COMMAND	Print and carriage return	PRINT COMMANDS
<b>DLE EOT</b>	EXECUTING COMMAND	Transmit real-time status	STATUS COMMANDS
<b>DLE ENQ</b>	EXECUTING COMMAND	Send real-time request to printer	MISCELLANEOUS COMMANDS
<b>DLE DC4 (fn = 1)</b>	EXECUTING COMMAND	Generate pulse in real-time	MISCELLANEOUS COMMANDS
<b>ESC SP</b>	SETTING COMMAND	Set right-side character spacing	CHARACTER COMMANDS
<b>ESC !</b>	SETTING COMMAND	Select print mode(s)	CHARACTER COMMANDS
<b>ESC %</b>	SETTING COMMAND	Select/cancel user-defined character set	CHARACTER COMMANDS
<b>ESC &amp;</b>	SETTING COMMAND	Define user-defined characters	CHARACTER COMMANDS
<b>ESC ( A</b>	EXECUTING + SETTING	Control beeper tones	MISCELLANEOUS COMMANDS
<b>ESC *</b>	EXECUTING COMMAND	Select bit-image mode	BIT-IMAGE COMMANDS
<b>ESC -</b>	SETTING COMMAND	Turn underline mode on/off	CHARACTER COMMANDS
<b>ESC 2</b>	SETTING COMMAND	Select default line spacing	LINE SPACING COMMANDS
<b>ESC 3</b>	SETTING COMMAND	Set line spacing	LINE SPACING COMMANDS

# CONFIDENTIAL

Command	Classification	Name	Function type
<b>ESC &lt;</b>	EXECUTING COMMAND	Return home	MECHANISM CONTROL COMMANDS
<b>ESC =</b>	SETTING COMMAND	Select peripheral device	MISCELLANEOUS COMMANDS
<b>ESC ?</b>	SETTING COMMAND	Cancel user-defined characters	CHARACTER COMMANDS
<b>ESC @</b>	EXECUTING + SETTING	Initialize printer	MISCELLANEOUS COMMANDS
<b>ESC D</b>	SETTING COMMAND	Set horizontal tab positions	PRINT POSITION COMMANDS
<b>ESC E</b>	SETTING COMMAND	Turn emphasized mode on/off	CHARACTER COMMANDS
<b>ESC G</b>	SETTING COMMAND	Turn double-strike mode on/off	CHARACTER COMMANDS
<b>ESC J</b>	EXECUTING COMMAND	Print and feed paper	PRINT COMMANDS
<b>ESC K</b>	EXECUTING COMMAND	Print and reverse feed	PRINT COMMANDS
<b>ESC M</b>	SETTING COMMAND	Select character font	CHARACTER COMMANDS
<b>ESC R</b>	SETTING COMMAND	Select an international character set	CHARACTER COMMANDS
<b>ESC U</b>	SETTING COMMAND	Turn unidirectional print mode on/off	MECHANISM CONTROL COMMANDS
<b>ESC a</b>	SETTING COMMAND	Select justification	PRINT POSITION COMMANDS
<b>ESC c 3</b>	SETTING COMMAND	Select paper sensor(s) to output paper-end signals	PAPER SENSOR COMMANDS
<b>ESC c 4</b>	SETTING COMMAND	Select paper sensor(s) to stop printing	PAPER SENSOR COMMANDS
<b>ESC c 5</b>	SETTING COMMAND	Enable/disable panel buttons	PANEL BUTTON COMMAND
<b>ESC d</b>	EXECUTING COMMAND	Print and feed <b>n</b> lines	PRINT COMMANDS

# CONFIDENTIAL

<b>Command</b>	<b>Classification</b>	<b>Name</b>	<b>Function type</b>
<b>ESC e</b>	EXECUTING COMMAND	Print and reverse feed <b>n</b> lines	PRINT COMMANDS
<b>ESC i</b>	EXECUTING COMMAND	Partial cut (one point left uncut)	MECHANISM CONTROL COMMANDS
<b>ESC m</b>	EXECUTING COMMAND	Partial cut (three points left uncut)	MECHANISM CONTROL COMMANDS
<b>ESC p</b>	EXECUTING COMMAND	Generate pulse	MISCELLANEOUS COMMANDS
<b>ESC r</b>	SETTING COMMAND	Select print color	CHARACTER COMMANDS
<b>ESC t</b>	SETTING COMMAND	Select character code table	CHARACTER COMMANDS
<b>ESC u</b>	EXECUTING COMMAND	Transmit peripheral device status	STATUS COMMANDS
<b>ESC v</b>	EXECUTING COMMAND	Transmit paper sensor status	STATUS COMMANDS
<b>ESC {</b>	SETTING COMMAND	Turn upside-down print mode on/off	CHARACTER COMMANDS
<b>FS !</b>	SETTING COMMAND	Select print mode(s) for Kanji characters	KANJI COMMANDS
<b>FS &amp;</b>	SETTING COMMAND	Select Kanji character mode	KANJI COMMANDS
<b>FS -</b>	SETTING COMMAND	Turn underline mode on/off for Kanji characters	KANJI COMMANDS
<b>FS .</b>	SETTING COMMAND	Cancel Kanji character mode	KANJI COMMANDS
<b>FS 2</b>	SETTING COMMAND	Define user-defined Kanji characters	KANJI COMMANDS
<b>FS C</b>	SETTING COMMAND	Select Kanji character code system	KANJI COMMANDS
<b>FS S</b>	SETTING COMMAND	Set Kanji character spacing	KANJI COMMANDS
<b>FS W</b>	SETTING COMMAND	Turn quadruple-size mode on/off for Kanji characters	KANJI COMMANDS

# CONFIDENTIAL

<b>Command</b>	<b>Classification</b>	<b>Name</b>	<b>Function type</b>
<b>FS ?</b>	SETTING COMMAND	Cancel user-defined Kanji characters	KANJI COMMANDS
<b>FS p</b>	EXECUTING COMMAND	Print NV bit image	BIT-IMAGE COMMANDS
<b>GS ( L GS 8 L</b>	EXECUTING + SETTING	Define NV bit image	BIT-IMAGE COMMANDS
<b>GS ( A</b>	EXECUTING COMMAND	Execute test print	MISCELLANEOUS COMMANDS
<b>GS ( C</b>	EXECUTING + SETTING	Edit NV user memory	CUSTOMIZE COMMANDS
<b>GS ( D</b>	SETTING COMMAND	Enable/disable real-time command	MISCELLANEOUS COMMANDS
<b>GS ( E</b>	EXECUTING + SETTING	Set user setup commands	CUSTOMIZE COMMANDS
<b>GS I</b>	EXECUTING COMMAND	Transmit printer ID	MISCELLANEOUS COMMANDS
<b>GS V</b>	EXECUTING COMMAND	Select cut mode and cut paper	MECHANISM CONTROL COMMANDS
<b>GS a</b>	EXECUTING + SETTING	Enable/disable Automatic Status Back (ASB)	STATUS COMMANDS
<b>GS r</b>	EXECUTING COMMAND	Transmit status	STATUS COMMANDS

## TM-U230 SUPPORTED COMMANDS

Command	Classification	Name	Function type
<b>HT</b>	EXECUTING COMMAND	Horizontal tab	PRINT POSITION COMMANDS
<b>LF</b>	EXECUTING COMMAND	Print and line feed	PRINT COMMANDS
<b>CR</b>	EXECUTING COMMAND	Print and carriage return	PRINT COMMANDS
<b>DLE EOT</b>	EXECUTING COMMAND	Transmit real-time status	STATUS COMMANDS
<b>DLE ENQ</b>	EXECUTING COMMAND	Send real-time request to printer	MISCELLANEOUS COMMANDS
<b>ESC SP</b>	SETTING COMMAND	Set right-side character spacing	CHARACTER COMMANDS
<b>ESC !</b>	SETTING COMMAND	Select print mode(s)	CHARACTER COMMANDS
<b>ESC %</b>	SETTING COMMAND	Select/cancel user-defined character set	CHARACTER COMMANDS
<b>ESC &amp;</b>	SETTING COMMAND	Define user-defined characters	CHARACTER COMMANDS
<b>ESC ( A</b>	EXECUTING + SETTING	Control beeper tones	MISCELLANEOUS COMMANDS
<b>ESC *</b>	EXECUTING COMMAND	Select bit-image mode	BIT-IMAGE COMMANDS
<b>ESC -</b>	SETTING COMMAND	Turn underline mode on/off	CHARACTER COMMANDS
<b>ESC 2</b>	SETTING COMMAND	Select default line spacing	LINE SPACING COMMANDS
<b>ESC 3</b>	SETTING COMMAND	Set line spacing	LINE SPACING COMMANDS
<b>ESC &lt;</b>	EXECUTING COMMAND	Return home	MECHANISM CONTROL COMMANDS
<b>ESC =</b>	SETTING COMMAND	Select peripheral device	MISCELLANEOUS COMMANDS



# CONFIDENTIAL

Command	Classification	Name	Function type
<b>ESC ?</b>	SETTING COMMAND	Cancel user-defined characters	CHARACTER COMMANDS
<b>ESC @</b>	EXECUTING + SETTING	Initialize printer	MISCELLANEOUS COMMANDS
<b>ESC D</b>	SETTING COMMAND	Set horizontal tab positions	PRINT POSITION COMMANDS
<b>ESC E</b>	SETTING COMMAND	Turn emphasized mode on/off	CHARACTER COMMANDS
<b>ESC G</b>	SETTING COMMAND	Turn double-strike mode on/off	CHARACTER COMMANDS
<b>ESC J</b>	EXECUTING COMMAND	Print and feed paper	PRINT COMMANDS
<b>ESC K</b>	EXECUTING COMMAND	Print and reverse feed	PRINT COMMANDS
<b>ESC R</b>	SETTING COMMAND	Select an international character set	CHARACTER COMMANDS
<b>ESC U</b>	SETTING COMMAND	Turn unidirectional print mode on/off	MECHANISM CONTROL COMMANDS
<b>ESC a</b>	SETTING COMMAND	Select justification	PRINT POSITION COMMANDS
<b>ESC c 3</b>	SETTING COMMAND	Select paper sensor(s) to output paper-end signals	PAPER SENSOR COMMANDS
<b>ESC c 4</b>	SETTING COMMAND	Select paper sensor(s) to stop printing	PAPER SENSOR COMMANDS
<b>ESC c 5</b>	SETTING COMMAND	Enable/disable panel buttons	PANEL BUTTON COMMAND
<b>ESC d</b>	EXECUTING COMMAND	Print and feed <b>n</b> lines	PRINT COMMANDS
<b>ESC e</b>	EXECUTING COMMAND	Print and reverse feed <b>n</b> lines	PRINT COMMANDS
<b>ESC p</b>	EXECUTING COMMAND	Generate pulse	MISCELLANEOUS COMMANDS
<b>ESC r</b>	SETTING COMMAND	Select print color	CHARACTER COMMANDS

# CONFIDENTIAL

<b>Command</b>	<b>Classification</b>	<b>Name</b>	<b>Function type</b>
<b>ESC t</b>	SETTING COMMAND	Select character code table	CHARACTER COMMANDS
<b>ESC {</b>	SETTING COMMAND	Turn upside-down print mode on/off	CHARACTER COMMANDS
<b>GS ( A</b>	EXECUTING COMMAND	Execute test print	MISCELLANEOUS COMMANDS
<b>GS I</b>	EXECUTING COMMAND	Transmit printer ID	MISCELLANEOUS COMMANDS
<b>GS V</b>	EXECUTING COMMAND	Select cut mode and cut paper	MECHANISM CONTROL COMMANDS
<b>GS a</b>	EXECUTING + SETTING	Enable/disable Automatic Status Back (ASB)	STATUS COMMANDS
<b>GS r</b>	EXECUTING COMMAND	Transmit status	STATUS COMMANDS
<b>GS z 0</b>	SETTING COMMAND	Set online recovery wait time	MISCELLANEOUS COMMANDS

## TM-P60 SUPPORTED COMMANDS

Command	Classification	Name	Function type
<b>HT</b>	EXECUTING COMMAND	Horizontal tab	PRINT POSITION COMMANDS
<b>LF</b>	EXECUTING COMMAND	Print and line feed	PRINT COMMANDS
<b>FF (in page mode)</b>	EXECUTING COMMAND	Print and return to standard mode (in page mode)	PRINT COMMANDS
<b>CAN</b>	EXECUTING COMMAND	Cancel print data in page mode	CHARACTER COMMANDS
<b>DLE EOT</b>	EXECUTING COMMAND	Transmit real-time status	STATUS COMMANDS
<b>DLE ENQ</b>	EXECUTING COMMAND	Send real-time request to printer	MISCELLANEOUS COMMANDS
<b>DLE DC4 (fn = 1)</b>	EXECUTING COMMAND	Generate pulse in real-time	MISCELLANEOUS COMMANDS
<b>DLE DC4 (fn = 2)</b>	EXECUTING COMMAND	Execute power-off sequence	MISCELLANEOUS COMMANDS
<b>DLE DC4 (fn = 8)</b>	EXECUTING COMMAND	Clear buffer(s)	MISCELLANEOUS COMMANDS
<b>ESC FF</b>	EXECUTING COMMAND	Print data in page mode	PRINT COMMANDS
<b>ESC SP</b>	SETTING COMMAND	Set right-side character spacing	CHARACTER COMMANDS
<b>ESC \$</b>	EXECUTING COMMAND	Set absolute print position	PRINT POSITION COMMANDS
<b>ESC ( A</b>	EXECUTING + SETTING	Control beeper tones	MISCELLANEOUS COMMANDS
<b>ESC -</b>	SETTING COMMAND	Turn underline mode on/off	CHARACTER COMMANDS
<b>ESC 3</b>	SETTING COMMAND	Set line spacing	LINE SPACING COMMANDS

# CONFIDENTIAL

<b>Command</b>	<b>Classification</b>	<b>Name</b>	<b>Function type</b>
<b>ESC =</b>	SETTING COMMAND	Select peripheral device	MISCELLANEOUS COMMANDS
<b>ESC @</b>	EXECUTING + SETTING	Initialize printer	MISCELLANEOUS COMMANDS
<b>ESC D</b>	SETTING COMMAND	Set horizontal tab positions	PRINT POSITION COMMANDS
<b>ESC E</b>	SETTING COMMAND	Turn emphasized mode on/off	CHARACTER COMMANDS
<b>ESC J</b>	EXECUTING COMMAND	Print and feed paper	PRINT COMMANDS
<b>ESC L</b>	EXECUTING COMMAND	Select page mode	MISCELLANEOUS COMMANDS
<b>ESC M</b>	SETTING COMMAND	Select character font	CHARACTER COMMANDS
<b>ESC R</b>	SETTING COMMAND	Select an international character set	CHARACTER COMMANDS
<b>ESC S</b>	EXECUTING COMMAND	Select standard mode	MISCELLANEOUS COMMANDS
<b>ESC T</b>	SETTING COMMAND	Select print direction in page mode	PRINT POSITION COMMANDS
<b>ESC W</b>	SETTING COMMAND	Set print area in page mode	PRINT POSITION COMMANDS
<b>ESC \</b>	EXECUTING COMMAND	Set relative print position	PRINT POSITION COMMANDS
<b>ESC a</b>	SETTING COMMAND	Select justification	PRINT POSITION COMMANDS
<b>ESC c 5</b>	SETTING COMMAND	Enable/disable panel buttons	PANEL BUTTON COMMAND
<b>ESC d</b>	EXECUTING COMMAND	Print and feed <b>n</b> lines	PRINT COMMANDS
<b>ESC t</b>	SETTING COMMAND	Select character code table	CHARACTER COMMANDS
<b>ESC {</b>	SETTING COMMAND	Turn upside-down print mode on/off	CHARACTER COMMANDS
<b>GS !</b>	SETTING COMMAND	Select character size	CHARACTER COMMANDS

# CONFIDENTIAL

<b>Command</b>	<b>Classification</b>	<b>Name</b>	<b>Function type</b>
<b>GS \$</b>	EXECUTING COMMAND	Set absolute vertical print position in page mode	PRINT POSITION COMMANDS
<b>GS ( C</b>	EXECUTING + SETTING	Edit NV user memory	CUSTOMIZE COMMANDS
<b>GS ( D</b>	SETTING COMMAND	Enable/disable real-time command	MISCELLANEOUS COMMANDS
<b>GS ( E</b>	EXECUTING + SETTING	Set user setup commands	CUSTOMIZE COMMANDS
<b>GS ( H</b>	EXECUTING COMMAND	Request transmission of response or status	MISCELLANEOUS COMMANDS
<b>GS ( K</b>	SETTING COMMAND	Select print control method(s)	MISCELLANEOUS COMMANDS
<b>GS ( L GS 8 L</b>	EXECUTING + SETTING	Set graphics data	BIT-IMAGE COMMANDS
<b>GS ( M</b>	SETTING COMMAND	Customize printer control value(s)	CUSTOMIZE COMMANDS
<b>GS ( P</b>	EXECUTING COMMAND	Page mode control	CUSTOMIZE COMMANDS
<b>GS ( Q</b>	EXECUTING COMMAND	Commands for drawing graphics	CUSTOMIZE COMMANDS
<b>GS B</b>	SETTING COMMAND	Turn white/black reverse print mode on/off	CHARACTER COMMANDS
<b>GS H</b>	SETTING COMMAND	Select print position of HRI characters	BAR CODE COMMANDS
<b>GS I</b>	EXECUTING COMMAND	Transmit printer ID	MISCELLANEOUS COMMANDS
<b>GS L</b>	SETTING COMMAND	Set left margin	PRINT POSITION COMMANDS
<b>GS V</b>	EXECUTING COMMAND	Select cut mode and cut paper	MECHANISM CONTROL COMMANDS
<b>GS W</b>	SETTING COMMAND	Set print area width	PRINT POSITION COMMANDS
<b>GS \</b>	EXECUTING COMMAND	Set relative vertical print position in page mode	PRINT POSITION COMMANDS

# CONFIDENTIAL

<b>Command</b>	<b>Classification</b>	<b>Name</b>	<b>Function type</b>
<b>GS a</b>	EXECUTING + SETTING	Enable/disable Automatic Status Back (ASB)	STATUS COMMANDS
<b>GS b</b>	SETTING COMMAND	Turn smoothing mode on/off	CHARACTER COMMANDS
<b>GS f</b>	SETTING COMMAND	Select font for HRI characters	BAR CODE COMMANDS
<b>GS g 0</b>	SETTING COMMAND	Initialize maintenance counter	MISCELLANEOUS COMMANDS
<b>GS g 2</b>	EXECUTING COMMAND	Transmit maintenance counter	MISCELLANEOUS COMMANDS
<b>GS h</b>	SETTING COMMAND	Set bar code height	BAR CODE COMMANDS
<b>GS k</b>	EXECUTING COMMAND	Print bar code	BAR CODE COMMANDS
<b>GS r</b>	EXECUTING COMMAND	Transmit status	STATUS COMMANDS
<b>GS w</b>	SETTING COMMAND	Set bar code width	BAR CODE COMMANDS

## COMMANDS IN ALPHANUMERIC ORDER

In this table, click any name to see the command description with program examples and print samples.

The print samples are images of the printing results of the program examples; they do not represent actual printing.

Command	Name	Function type
<a href="#">HT</a>	Horizontal tab	PRINT POSITION COMMANDS
<a href="#">LF</a>	Print and line feed	PRINT COMMANDS
<a href="#">FF (in page mode)</a>	Print and return to standard mode	PRINT COMMANDS
<a href="#">CR</a>	Print and carriage return	PRINT COMMANDS
<a href="#">CAN</a>	Cancel print data in page mode	CHARACTER COMMANDS
<a href="#">DLE EOT</a>	Real-time status transmission	STATUS COMMANDS
<a href="#">DLE ENQ</a>	Real-time request to printer	MISCELLANEOUS COMMANDS
<a href="#">DLE DC4 (fn = 1)</a>	Generate pulse at real-time	MISCELLANEOUS COMMANDS
<a href="#">DLE DC4 (fn = 2)</a>	Turn off the power	MISCELLANEOUS COMMANDS
<a href="#">DLE DC4 (fn = 7 )</a>	Transmit specified status in real time	MISCELLANEOUS COMMANDS
<a href="#">DLE DC4 (fn = 8)</a>	Clear buffer	MISCELLANEOUS COMMANDS
<a href="#">ESC FF</a>	Print data in page mode	PRINT COMMANDS
<a href="#">ESC SP</a>	Set right-side character spacing	CHARACTER COMMANDS
<a href="#">ESC !</a>	Select print mode(s)	CHARACTER COMMANDS

**\* obsolete command**

# CONFIDENTIAL

<b>Command</b>	<b>Name</b>	<b>Function type</b>
<b>ESC \$</b>	Set absolute print position	PRINT POSITION COMMANDS
<b>ESC %</b>	Select/cancel user-defined character set	CHARACTER COMMANDS
<b>ESC &amp;</b>	Define user-defined characters	CHARACTER COMMANDS
<b>ESC ( A</b>	Control of the beeper	MISCELLANEOUS COMMANDS
<b>ESC *</b>	Select bit-image mode	BIT-IMAGE COMMANDS
<b>ESC -</b>	Turn underline mode on/off	CHARACTER COMMANDS
<b>ESC 2</b>	Select default line spacing	LINE SPACING COMMANDS
<b>ESC 3</b>	Set line spacing	LINE SPACING COMMANDS
<b>ESC &lt;</b>	Return home	MECHANISM CONTROL COMMANDS
<b>ESC =</b>	Select peripheral device	MISCELLANEOUS COMMANDS
<b>ESC ?</b>	Cancel user-defined characters	CHARACTER COMMANDS
<b>ESC @</b>	Initialize printer	MISCELLANEOUS COMMANDS
<b>ESC D</b>	Set horizontal tab positions	PRINT POSITION COMMANDS
<b>ESC E</b>	Turn emphasized mode on/off	CHARACTER COMMANDS
<b>ESC G</b>	Turn double-strike mode on/off	CHARACTER COMMANDS
<b>ESC J</b>	Print and feed paper	PRINT COMMANDS
<b>ESC K</b>	Print and reverse feed	PRINT COMMANDS
<b>ESC L</b>	Select page mode	MISCELLANEOUS COMMANDS



# CONFIDENTIAL

Command	Name	Function type
<b>ESC M</b>	Select character font	CHARACTER COMMANDS
<b>ESC R</b>	Select an international character set	CHARACTER COMMANDS
<b>ESC S</b>	Select standard mode	MISCELLANEOUS COMMANDS
<b>ESC T</b>	Select print direction in page mode	PRINT POSITION COMMANDS
<b>ESC U</b>	Turn unidirectional printing mode on/off	MECHANISM CONTROL COMMANDS
<b>ESC V</b>	Turn 90° clockwise rotation mode on/off	CHARACTER COMMANDS
<b>ESC W</b>	Set printing area in page mode	PRINT POSITION COMMANDS
<b>ESC \</b>	Set relative print position	PRINT POSITION COMMANDS
<b>ESC a</b>	Select justification	PRINT POSITION COMMANDS
<b>ESC c 3</b>	Select paper sensor(s) to output paper-end signals	PAPER SENSOR COMMANDS
<b>ESC c 4</b>	Select paper sensor(s) to stop printing	PAPER SENSOR COMMANDS
<b>ESC c 5</b>	Enable/disable panel buttons	PANEL BUTTON COMMAND
<b>ESC d</b>	Print and feed <b>n</b> lines	PRINT COMMANDS
<b>ESC e</b>	Print and reverse feed <b>n</b> lines	PRINT COMMANDS
<b>* ESC i</b>	Partial cut (one point left uncut)	MECHANISM CONTROL COMMANDS
<b>* ESC m</b>	Partial cut (three points left uncut)	MECHANISM CONTROL COMMANDS
<b>ESC p</b>	Generate pulse	MISCELLANEOUS COMMANDS
<b>ESC r</b>	Select print color	CHARACTER COMMANDS

**\* obsolete command**

# CONFIDENTIAL

Command	Name	Function type
<b>ESC t</b>	Select character code table	CHARACTER COMMANDS
<b>* ESC u</b>	Transmit peripheral device status	STATUS COMMANDS
<b>ESC {</b>	Turn upside-down printing mode on/off	CHARACTER COMMANDS
<b>FS !</b>	Set print mode(s) for Kanji characters	KANJI COMMANDS
<b>FS &amp;</b>	Select Kanji character mode	KANJI COMMANDS
<b>FS ( A</b>	Define character effects of Kanji characters.	KANJI COMMANDS
<b>FS ( L</b>	Control of the label paper / black mark paper	PRINTING PAPER COMMANDS
<b>FS -</b>	Turn underline mode on/off for Kanji characters	KANJI COMMANDS
<b>FS .</b>	Cancel Kanji character mode	KANJI COMMANDS
<b>FS 2</b>	Define user-defined Kanji characters	KANJI COMMANDS
<b>FS C</b>	Select Kanji character code system	KANJI COMMANDS
<b>FS S</b>	Set Kanji character spacing	KANJI COMMANDS
<b>FS W</b>	Turn quadruple-size mode on/off for Kanji characters	KANJI COMMANDS
<b>FS ?</b>	Cancel user-defined Kanji characters	KANJI COMMANDS
<b>* FS g 1</b>	Write to NV user memory	CUSTOMIZE COMMANDS
<b>* FS g 2</b>	Read from NV user memory	CUSTOMIZE COMMANDS
<b>* FS p</b>	Print NV bit image	BIT-IMAGE COMMANDS
<b>* FS q</b>	Define NV bit image	BIT-IMAGE COMMANDS

**\* obsolete command**

# CONFIDENTIAL

Command	Name	Function type
<b>GS !</b>	Select character size	CHARACTER COMMANDS
<b>GS \$</b>	Set absolute vertical print position in page mode	PRINT POSITION COMMANDS
<b>GS ( A</b>	Execute test print	MISCELLANEOUS COMMANDS
<b>GS ( C</b>	Edit NV user memory	CUSTOMIZE COMMANDS
<b>GS ( D</b>	Enable/disable real-time command	MISCELLANEOUS COMMANDS
<b>GS ( E</b>	User setup commands	CUSTOMIZE COMMANDS
<b>GS ( H</b>	Require response transmission	MISCELLANEOUS COMMANDS
<b>GS ( K</b>	Select printing control	MISCELLANEOUS COMMANDS
<b>GS ( L GS 8 L</b>	Specify graphics data	BIT-IMAGE COMMANDS
<b>GS ( M</b>	Customize printer control value(s)	CUSTOMIZE COMMANDS
<b>GS ( N</b>	Select character effects	CHARACTER COMMANDS
<b>GS ( k</b>	Specify and print the symbol	TWO DIMENSION CODE COMMANDS
<b>* GS *</b>	Define downloaded bit image	BIT-IMAGE COMMANDS
<b>* GS /</b>	Print downloaded bit image	BIT-IMAGE COMMANDS
<b>GS :</b>	Start/end macro definition	MACRO FUNCTION COMMANDS
<b>GS B</b>	Turn white/black reverse printing mode on/off	CHARACTER COMMANDS
<b>* GS C 0</b>	Select counter print mode	COUNTER PRINTING COMMANDS
<b>* GS C 1</b>	Select count mode (A)	COUNTER PRINTING COMMANDS
<b>* GS C 2</b>	Select counter print mode	COUNTER PRINTING COMMANDS

# CONFIDENTIAL

Command	Name	Function type
* <b>GS C ;</b>	Select counter mode (B)	COUNTER PRINTING COMMANDS
<b>GS H</b>	Select printing position of HRI characters	BAR CODE COMMANDS
<b>GS I</b>	Transmit printer ID	MISCELLANEOUS COMMANDS
<b>GS L</b>	Set left margin	PRINT POSITION COMMANDS
<b>GS P</b>	Set horizontal and vertical motion units	MISCELLANEOUS COMMANDS
* <b>GS Q 0</b>	Print variable vertical size bit image	BIT-IMAGE COMMANDS
<b>GS T</b>	Set print position to the beginning of print line	PRINT POSITION COMMANDS
<b>GS V</b>	Select cut mode and cut paper	MECHANISM CONTROL COMMANDS
<b>GS W</b>	Set printing area width	PRINT POSITION COMMANDS
<b>GS \</b>	Set relative vertical print position in page mode	PRINT POSITION COMMANDS
<b>GS ^</b>	Execute macro	MACRO FUNCTION COMMANDS
<b>GS a</b>	Enable/disable Automatic Status Back (ASB)	STATUS COMMANDS
<b>GS b</b>	Turn smoothing mode on/off	CHARACTER COMMANDS
* <b>GS c</b>	Print counter	COUNTER PRINTING COMMANDS
<b>GS f</b>	Select font for HRI characters	BAR CODE COMMANDS
<b>GS g 0</b>	Initialize maintenance counter	MISCELLANEOUS COMMANDS
<b>GS g 2</b>	Transmit maintenance counter	MISCELLANEOUS COMMANDS
<b>GS h</b>	Set bar code height	BAR CODE COMMANDS

\* **obsolete command**

# CONFIDENTIAL

Command	Name	Function type
<b>GS j</b>	Enable/disable Ink Automatic Status Back (ASB)	STATUS COMMANDS
<b>GS k</b>	Print bar code	BAR CODE COMMANDS
<b>GS r</b>	Transmit status	STATUS COMMANDS
* <b>GS v 0</b>	Print raster bit image	BIT-IMAGE COMMANDS
<b>GS w</b>	Set bar code width	BAR CODE COMMANDS
<b>GS z 0</b>	Set online recovery wait time	MISCELLANEOUS COMMANDS
<b>GS z 0 (TM-L90 w/ Peeler)</b>	Set online recovery wait time	MISCELLANEOUS COMMANDS

\* **obsolete command**

# CONFIDENTIAL

The following commands are supported only by Simplified Chinese/Traditional Chinese/Japanese models.

<b>Command</b>	<b>Name</b>	<b>Function type</b>
<b>FS !</b>	Set print mode(s) for Kanji characters	KANJI COMMANDS
<b>FS &amp;</b>	Select Kanji character mode	KANJI COMMANDS
<b>FS ( A</b>	Define character effects of Kanji characters	KANJI COMMANDS
<b>FS -</b>	Turn underline mode on/off for Kanji characters	KANJI COMMANDS
<b>FS .</b>	Cancel Kanji character mode	KANJI COMMANDS
<b>FS 2</b>	Define user-defined Kanji characters	KANJI COMMANDS
<b>FS C</b>	Select Kanji character code system	KANJI COMMANDS
<b>FS S</b>	Set Kanji character spacing	KANJI COMMANDS
<b>FS W</b>	Turn quadruple-size mode on/off for Kanji characters	KANJI COMMANDS
<b>FS ?</b>	Cancel user-defined Kanji characters	KANJI COMMANDS

The following commands are obsolete commands and will not be supported by future printer models. More suitable substitute commands are listed to the right.

Command	Name	Function type	Substitute command
<b>ESC i</b>	Partial cut (one point left uncut)	MECHANISM CONTROL COMMANDS	<b>GS V</b>
<b>ESC m</b>	Partial cut (three points left uncut)	MECHANISM CONTROL COMMANDS	<b>GS V</b>
<b>ESC u</b>	Transmit peripheral device status	STATUS COMMANDS	<b>GS r</b>
<b>ESC v</b>	Transmit paper sensor status	STATUS COMMANDS	<b>GS r</b>
<b>FS g 1</b>	Write to NV user memory	CUSTOMIZE COMMANDS	<b>GS ( C</b>
<b>FS g 2</b>	Read from NV user memory	CUSTOMIZE COMMANDS	<b>GS ( C</b>
<b>FS p</b>	Print NV bit image	BIT-IMAGE COMMANDS	<b>GS ( L GS 8 L</b>
<b>GS ( L GS 8 L</b>	Define NV bit image	BIT-IMAGE COMMANDS	<b>GS ( L GS 8 L</b>
<b>GS *</b>	Define downloaded bit image	BIT-IMAGE COMMANDS	<b>GS ( L GS 8 L</b>
<b>GS \</b>	Print downloaded bit image	BIT-IMAGE COMMANDS	<b>GS ( L GS 8 L</b>
<b>GS C 0</b>	Select counter print mode	COUNTER PRINTING COMMANDS	NONE
<b>GS C 1</b>	Select count mode (A)	COUNTER PRINTING COMMANDS	NONE
<b>GS C 2</b>	Select counter print mode	COUNTER PRINTING COMMANDS	NONE
<b>GS C ;</b>	Select counter mode (B)	COUNTER PRINTING COMMANDS	NONE
<b>GS Q 0</b>	Print variable vertical size bit image	BIT-IMAGE COMMANDS	<b>GS ( L</b>
<b>GS c</b>	Print counter	COUNTER PRINTING COMMANDS	NONE
<b>GS v 0</b>	Print raster bit image	BIT-IMAGE COMMANDS	<b>GS ( L</b>

## COMMANDS ARRANGED BY FUNCTION

---

Click any item to see the commands in that category.

[\*\*Print Commands\*\*](#)

[\*\*Line Spacing Commands\*\*](#)

[\*\*Character Commands\*\*](#)

[\*\*Panel Button Commands\*\*](#)

[\*\*Paper Sensor Commands\*\*](#)

[\*\*Print Position Commands\*\*](#)

[\*\*Bit Image Commands\*\*](#)

[\*\*Status Commands\*\*](#)

[\*\*Bar code Commands\*\*](#)

[\*\*Macro Function Commands\*\*](#)

[\*\*Mechanism Control Commands\*\*](#)

[\*\*Miscellaneous Commands\*\*](#)

[\*\*Kanji Commands\*\*](#)

[\*\*Two Dimension Code Commands\*\*](#)

[\*\*Customize Commands\*\*](#)

[\*\*Counter Printing Commands\*\*](#)

[\*\*Printing Paper Commands\*\*](#)



## PRINT COMMANDS

Command	Name
---------	------

---

<b>LF</b>	Print and line feed
<b>FF (in page mode)</b>	Print and return to standard mode (in page mode)
<b>CR</b>	Print and carriage return
<b>ESC FF</b>	Print data in page mode
<b>ESC J</b>	Print and feed paper
<b>ESC K</b>	Print and reverse feed
<b>ESC d</b>	Print and feed <b>n</b> lines
<b>ESC e</b>	Print and reverse feed <b>n</b> lines

## LF

[Name] Print and line feed

[Format] ASCII LF  
Hex 0A  
Decimal 10

[Range] None

[Default] None

[Printers not featuring this command] None

[Description] Prints the data in the print buffer and feeds one line, based on the current line spacing.

- [Notes]
- The amount of paper fed per line is based on the value set using the line spacing command (**ESC 2** or **ESC 3**).
  - After printing, the print position moves to the beginning of the line. When a left margin is set in standard mode, the position of the left margin is the beginning of the line.
  - When this command is processed in page mode, only the print position moves, and the printer does not perform actual printing.

[Model-dependent variations] **TM-L90**

### Program Example for all printers

```
PRINT #1, "AAAAA"; CHR$(&HA);
PRINT #1, "BBBBB"; CHR$(&HA);
```

### Print Sample

```
AAAAA
BBBBB
```

## TM-L90

**When the origin of layout is selected to bottom of label or top of black mark in standard mode and a paper feed amount that exceeds the remaining printable area of the label is sent, the printer executes one of the following:**

- **If the printer will print a line that is higher than the remaining printable area of the label, the printer feeds the label to the next print starting position and the printer executes this command.**
- **If the printer will print in the remaining printable area of the label, but the feed amount exceeds the remaining printable area of the label, the printer prints the label and feeds to bottom of the label.**

## FF (in page mode)

[Name]	Print and return to standard mode (in page mode)
[Format]	ASCII      FF Hex        0C Decimal    12
[Default]	None
[Range]	None
[Printers not featuring this command]	<b>TM-U230</b> , <b>TM-U220</b>
[Description]	In page mode, prints all the data in the print buffer collectively and switches from page mode to standard mode.
[Notes]	<ul style="list-style-type: none"> <li>■ This command is enabled only in page mode. See <b>FF</b> (in standard mode) to use this command in standard mode. Page mode can be selected by <b>ESC L</b> or <b>FS L</b>.</li> <li>■ The data is deleted in the print area after being printed.</li> <li>■ This command returns the values set by <b>ESC W</b> to the default values.</li> <li>■ The value set by <b>ESC T</b> is maintained.</li> <li>■ After printing, the print position moves to the beginning of the line. When a left margin is set, the position of the left margin is the beginning of the line.</li> </ul>

# CONFIDENTIAL

[Model-dependent variations] None

## Program Example for all printers

```
PRINT #1, CHR$(&H1B);"L"; ←Select page mode
PRINT #1, CHR$(&H1D);"P";CHR$(180);CHR$(180);
PRINT #1, CHR$(&H1B);"W";CHR$(0);CHR$(0);CHR$(0);
CHR$(0);CHR$(60);CHR$(0);CHR$(90);CHR$(0);
PRINT #1, CHR$(&H1B);"T";CHR$(0);
PRINT #1, "AAAAA"; CHR$(&HA); ←Store characters for printing
PRINT #1, "BBBBB"; CHR$(&HA); ←Store characters for printing
PRINT #1, "CCCCC"; CHR$(&HC); ←Batch print
```

## Print Sample

```
AAAAA
BBBBB
CCCCC
```

## CR

[Name] Print and carriage return

[Format] ASCII CR  
Hex 0D  
Decimal 13

[Range] None

[Default] None

[Printers not featuring this command] **TM-P60**

[Description] Executes one of the following operations.

Print head	When auto line feed is enabled	When auto line feed is disabled
Line thermal	Executes printing and one line feed as <b>LF</b>	This command is ignored
Serial dot head	Executes printing and one line feed as <b>LF</b>	In standard mode, prints the data in the print buffer and moves the print position to the beginning of the print line. In page mode, moves the print position to the beginning of the print line.

- [Notes]
- With a serial interface, the command performs as if auto line feed is disabled.
  - With a parallel interface, enabling or disabling the auto line feed can be selected by the DIP switch or the memory switch. Memory switch can be changed with **GS ( E <Function3>**.
  - After printing, the print position moves to the beginning of the line. When a left margin is set in standard mode, the position of the left margin is the beginning of the line.
  - When this command is processed in page mode, only the print position moves, and the printer does not perform actual printing.

[Model-dependent variations]

**TM-J2000/J2100**, **TM-T90**, **TM-T88IV**, **TM-T70**, **TM-L90**, **TM-U230**, **TM-U220**

```
Program Example (Line thermal)  
  
PRINT #1, "AAAAA";CHR$(&HD);  
PRINT #1, "      BBBB";CHR$(&HA);
```

```
Print Sample (Line thermal)  
  
AAAAA      ←Auto line feed enabled  
          BBBB  
AAAAA      BBBB ←Auto line feed disabled
```

```
Program Example (Serial dot head)  
  
PRINT #1, "AAAAA";CHR$(&HD);  
PRINT #1, "      BBBB";CHR$(&HA);
```

```
Print Sample (Serial dot head)  
  
AAAAA  
          BBBB ←Auto line feed enabled  
AAAAABBBBB ←Auto line feed disabled
```

## **TM-J2000/J2100**

**Auto line feed for a parallel interface is selected by Memory switch 1-5.**

**This printer has only a serial dot head.**

## **TM-T90**

**Auto line feed for a parallel interface is selected by Memory switch 1-5.**

**This printer has only a line thermal head.**

## **TM-T88IV, TM-T70**

**Auto line feed for a parallel interface is selected by DIP switch 1-1.**

**This printer has only a line thermal head.**

# C O N F I D E N T I A L

## **TM-L90**

**Auto line feed for a parallel interface is selected by Memory switch 1-5.  
This printer has only a line thermal head.**

## **TM-U230**

**Auto line feed for a parallel interface is selected by DIP switch 1-1.  
This printer has only a serial dot head.**

## **TM-U220**

**Auto line feed for a parallel interface is selected by DIP switch 1-1.  
This printer has only a serial dot head.**

## ESC FF

[Name] Print data in page mode

[Format] ASCII ESC FF  
Hex 1B 0C  
Decimal 27 12

[Range] None

[Default] None

[Printers not featuring this command] **TM-U230, TM-U220**

[Description] In page mode, prints the data in the print buffer collectively.

- [Notes]
- This command is enabled only in page mode. Page mode can be selected by **ESC L**.
  - After printing, the printer does not clear the buffered data, the print position, or values set by other commands.
  - The printer returns to standard mode with **FF, ESC S**, and **ESC @**. When it returns to standard mode by **ESC @**, all settings are canceled.
  - This command is used when the data in page mode is printed repeatedly.

[Model-dependent variations] None

### Program Example for all printers

```
PRINT #1, CHR$(&H1B);"L"; ←Select page mode
PRINT #1, CHR$(&H1D);"P";CHR$(180);CHR$(180);
PRINT #1, CHR$(&H1B);"W";CHR$(0);CHR$(0);CHR$(0);
CHR$(0);CHR$(120);CHR$(0);CHR$(170);CHR$(0);
PRINT #1, CHR$(&H1B);"T";CHR$(0); ←Select print direction
PRINT #1, "AAAAA"; CHR$(&HA); ←Store characters for printing
PRINT #1, "BBBBB"; CHR$(&HA); ←Store characters for printing
PRINT #1, "CCCCC"; CHR$(&H1B);CHR$(&HC); ←Batch print
PRINT #1, CHR$(&HC); ←Batch print and return to standard mode
```

### Print Sample

```
AAAAA
BBBBB
CCCCC
```

```
AAAAA
BBBBB
CCCCC
```



## ESC J

[Name] Print and feed paper

[Format] ASCII ESC J **n**  
 Hex 1B 4A **n**  
 Decimal 27 74 **n**

[Range]  $0 \leq n \leq 255$

[Default] None

[Printers not featuring this command] None

[Description] Prints the data in the print buffer and feeds the paper **n** × (vertical or horizontal motion unit).

- [Notes]
- The maximum paper feed amount is 1016 mm {40 inches}. If the specified amount exceeds 1016 mm {40 inches}, the paper feed amount is automatically set to 1016 mm {40 inches}.
  - When standard mode is selected, the vertical motion unit is used.
  - When page mode is selected, the vertical or horizontal motion unit is used for the print direction set by **ESC T**.
    - When the starting position is set to the upper left or lower right of the print area using **ESC T**, the vertical motion unit is used.
    - When the starting position is set to the upper right or lower left of the print area using **ESC T**, the horizontal motion unit is used.
  - After printing, the print position moves to the beginning of the line. When a left margin is set in standard mode, the position of the left margin is the beginning of the line.
  - When this command is processed in page mode, only the print position moves; the printer does not perform actual printing.
  - This command is used to temporarily feed a specific length without changing the line spacing set by other commands.

# CONFIDENTIAL

[Model-dependent variations] **TM-J2000/J2100**, **TM-T90**, **TM-T70**, **TM-T88IV**, **TM-L90**, **TM-P60**, **TM-U230**,  
**TM-U220**

```
Program Example for all printers

PRINT #1, CHR$( &H1D ); "P";CHR$(180);CHR$(180);
PRINT #1, "AAAAA"; CHR$( &HA );
PRINT #1, "BBBBB"; CHR$( &H1B ); "J";CHR$(100);
PRINT #1, "CCCCC"; CHR$( &HA );
PRINT #1, "DDDDD"; CHR$( &HA );
```

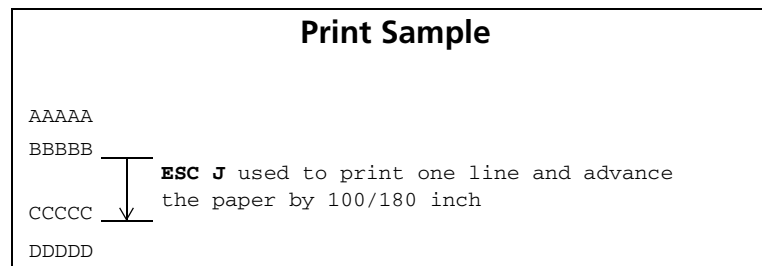

## **TM-J2000/J2100**

The vertical or horizontal motion unit is specified by **GS P**.

## **TM-T90, TM-T70**

The vertical or horizontal motion unit is specified by **GS P**.

In standard mode, if the character height is greater than the specified paper feed amount, the paper is fed the amount of the character height. For example, if a paper feed of 30 dots is specified with **ESC J**, but the character height is 48 dots, the paper is fed 48 dots.

The amount of paper feed of the Japanese model can be specified up to 900 mm {35.4 inches}. When an amount of paper feed that exceeds the maximum value is specified, the paper feed of the maximum amount is executed.

## **TM-T88IV**

The vertical or horizontal motion unit is specified by **GS P**.

In standard mode, if the character height is greater than the specified paper feed amount, the paper is fed the amount of the character height. For example, if a paper feed of 30 dots is specified with **ESC J**, but the character height is 48 dots, the paper is fed 48 dots.

## TM-L90

The vertical or horizontal motion unit is specified by **GS P**.

In standard mode, if the character height is greater than the specified paper feed amount, the paper is fed the amount of the character height. For example, if a paper feed of 30 dots is specified with **ESC J**, but the character height is 48 dots, the paper is fed 48 dots.

When the origin of layout is selected to bottom of label or top of black mark in standard mode and a paper feed amount that exceeds the remaining printable area of the label is sent, the printer executes one of the following:

- If the printer will print a line that is higher than the remaining printable area of the label, the printer feeds the label to the next print starting position and the printer executes this command.
- If the printer will print in the remaining printable area of the label, but a feed amount that exceeds the remaining printable area of the labels is sent, the printer prints on the label and feeds to bottom of the label.

The amount of paper feed of the Japanese Kanji model can be up to 900 mm {35.4 inches}. When the amount of paper feed exceeding the maximum is specified, the maximum paper feed is executed.

## TM-P60

The vertical or horizontal motion unit is approximately 0.125 mm {1/203 inches}. This value equals one dot pitch.

In standard mode, if the character height is greater than the specified paper feed amount, the paper is fed the amount of the character height. For example, if a paper feed of 30 dots is specified with **ESC J**, but the character height is 48 dots, the paper is fed 48 dots.

## TM-U230

The vertical motion unit is 0.176 mm {1/144 inch}. This value equals a half dot pitch. This command does not use the horizontal motion unit because the printer does not support page mode.

## TM-U220

The vertical motion unit is 0.176 mm {1/144 inch}. This value equals a half dot pitch. This command does not use the horizontal motion unit because the printer does not support page mode.

## ESC K

[Name]	Print and reverse feed
[Format]	ASCII    ESC K <b>n</b> Hex        1B 4B <b>n</b> Decimal    27 75 <b>n</b>
[Range]	<b>TM-U230, TM-U220: <math>0 \leq n \leq 48</math></b>
[Default]	None
[Printers not featuring this command]	<b>TM-J2000/J2100, TM-T90, TM-T88IV, TM-T70, TM-L90, TM-P60</b>
[Description]	Prints the data in the print buffer and feeds the paper <b>n</b> × (vertical motion unit) in the reverse direction.
[Notes]	<ul style="list-style-type: none"> <li>■ The maximum paper feed amount depends on the printer model.</li> <li>■ After printing, the print position moves to the beginning of the line. When a left margin is set, the position of the left margin is the beginning of the line.</li> <li>■ When standard mode is selected, the vertical motion unit is used.</li> <li>■ When page mode is selected, the vertical or horizontal motion unit is used for the print direction set by <b>ESC T</b>.               <ul style="list-style-type: none"> <li>• When the starting position is set to the upper left or lower right of the print area using <b>ESC T</b>, the vertical motion unit is used.</li> <li>• When the starting position is set to the upper right or lower left of the print area using <b>ESC T</b>, the horizontal motion unit is used.</li> </ul> </li> <li>■ When this command is processed in page mode, only the print position moves; the printer does not perform actual printing.</li> <li>■ This command is used to temporarily feed a specific length without changing the line spacing set by other commands.</li> </ul>

[Model-dependent variations] **TM-U230**, **TM-U220**

## Program Example for all printers

```
PRINT #1, CHR$( &H1D ); "P"; CHR$( 180 ); CHR$( 180 );  
PRINT #1, "AAAAA"; CHR$( &HA );  
PRINT #1, "BBBBB"; CHR$( &H1B ); "K"; CHR$( 30 );  
PRINT #1, "      CCCCC"; CHR$( &HA );
```

## Print Sample

```
AAAAACCCCC  
BBBBB
```



ESC K used to print one line and then reverse  
feed the paper by 30/180 inch

## TM-U230

This command must not be executed consecutively more than two times. The vertical motion unit is 0.176 mm {1/144 inch}. This value equals a half dot pitch. In the reverse direction, the maximum paper feed amount is 8.467 mm {48/144 inch}. If the specified amount exceeds 8.467 mm {48/144 inch}, the printer only prints the data and does not feed the paper.

## TM-U220

This command must not be executed consecutively more than two times.

Reverse direction paper feeding causes the following problems:

- Paper feed pitch is incorrect.
- Printer noise is louder than normal.
- The paper may rub against the ribbon and become dirty.

The vertical motion unit is 0.176 mm {1/144 inch}. This value equals a half dot pitch. In the reverse direction, the maximum paper feed amount is 8.467 mm {48/144 inch}. If the specified amount exceeds 8.467 mm {48/144 inch}, the printer only prints the data and does not feed the paper.

## ESC d

[Name]	Print and feed <b>n</b> lines
[Format]	ASCII      ESC d <b>n</b> Hex        1B 64 <b>n</b> Decimal    27 100 <b>n</b>
[Range]	0 ≤ <b>n</b> ≤ 255
[Default]	None
[Printers not featuring this command]	None
[Description]	Prints the data in the print buffer and feeds <b>n</b> lines.
[Notes]	<ul style="list-style-type: none"> <li>■ The amount of paper fed per line is based on the value set using the line spacing command (<b>ESC 2</b> or <b>ESC 3</b>).</li> <li>■ The maximum paper feed amount is 1016 mm {40 inches}. If the specified amount exceeds 1016 mm {40 inches}, the paper feed amount is automatically set to 1016 mm {40 inches}.</li> <li>■ After printing, the print position moves to the beginning of the line. When a left margin is set in standard mode, the position of the left margin is the beginning of the line.</li> <li>■ When this command is processed in page mode, only the print position moves, and the printer does not perform actual printing.</li> <li>■ This command is used to temporarily feed a specific line without changing the line spacing set by other commands.</li> </ul>

# CONFIDENTIAL

[Model-dependent variations] **TM-T90, TM-T70, TM-L90**

## Program Example for all printers

```
PRINT #1, "AAAAA"; CHR$(&HA);  
PRINT #1, "BBBBB"; CHR$(&H1B); "d"; CHR$(6);  
PRINT #1, "CCCCC"; CHR$(&HA);
```

## Print Sample

AAAAA  
BBBBB

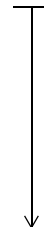

ESC d used to print one line and advance the paper by six lines

CCCCC

## **TM-T90, TM-T70**

The amount of paper feed of the Japanese Kanji model can specify even 900 mm or less {35.4 inches}. When the amount of paper feed which exceeds the maximum value is specified, the paper feed of the maximum amount is executed.

## **TM-L90**

When the label paper or the black mark paper is selected in standard mode and a paper feed amount that exceeds the remainder print area of the label, the printer feeds the label to the next print starting position.

The amount of paper feed can specify up to 900 mm {35.4 inches}. When the amount of paper feed which exceeds the maximum value is specified, the paper feed of the maximum amount is executed.

## ESC e

[Name] Print and reverse feed **n** lines

[Format] ASCII ESC e **n**  
 Hex 1B 65 **n**  
 Decimal 27 101 **n**

[Range] **TM-U230, TM-U220: 0 ≤ n ≤ 2**

[Default] None

[Printers not featuring this command] **TM-J2000/J2100, TM-T90, TM-T88IV, TM-T70, TM-L90, TM-P60**

[Description] Prints the data in the print buffer and feeds **n** lines in the reverse direction.

- [Notes]
- The amount of paper fed per line is based on the value set using the line spacing command (**ESC 2** or **ESC 3**).
  - The maximum paper feed amount depends on the printer model.
  - After printing, the print position moves to the beginning of the line. When a left margin is set, the position of the left margin is the beginning of the line.
  - When this command is processed in page mode, only the print position moves, and the printer does not perform actual printing.
  - This command is used to temporarily feed a specific line without changing the line spacing set by other commands.

[Model-dependent variations] **TM-U230, TM-U220**

### Program Example for all printers

```
PRINT #1, "AAAAA"; CHR$(&HA);
PRINT #1, "BBBBB"; CHR$(&H1B); "e"; CHR$(1);
PRINT #1, "      CCCCC"; CHR$(&HA);
```

### Print Sample

```
AAAAACCCCC
BBBBB
```



Paper reverse fed one line after printing the line of Bs



## TM-U230

This command must not be executed consecutively more than two times. In the reverse direction, the maximum paper feed amount is 8.467 mm {48/144 inch}. If the specified amount exceeds 8.467 mm {48/144 inch}, the printer only prints the data and does not feed the paper.

## TM-U220

This command must not be executed consecutively more than two times. Reverse direction paper feeding causes the following problems:

- Paper feed pitch is incorrect.
- Printer noise is louder than normal.
- The paper may rub against the ribbon and become dirty.

In the reverse direction, the maximum paper feed amount is 8.467 mm {48/144 inch}. If the specified amount exceeds 8.467 mm {48/144 inch}, the printer only prints the data and does not feed the paper.

## LINE SPACING COMMANDS

Command	Name
---------	------

<b>ESC 2</b>	Select default line spacing
<b>ESC 3</b>	Set line spacing

## ESC 2

[Name] Select default line spacing

[Format] ASCII      ESC 2  
 Hex        1B 32  
 Decimal    27 50

[Range] None

[Default] None

[Printers not featuring this command] **TM-P60**

[Description] Sets the line spacing to the "default line spacing."

- [Notes]
- The line spacing can be set independently in standard mode and in page mode.
    - In standard mode this command sets the line spacing of standard mode.
    - In page mode this command sets the line spacing of page mode.
  - Selected line spacing is effective until **ESC 3** is executed, **ESC @** is executed, the printer is reset, or the power is turned off.

[Model-dependent variations]      **TM-J2000/J2100, TM-T90, TM-T70, TM-T88IV, TM-L90, TM-U230, TM-U220**

**See program example and print sample for ESC 2 and ESC 3.**

### **TM-J2000/J2100**

**The default line spacing is about 4.23 mm {1/6 inch}, which is equivalent to 30 dots.**

### **TM-T90, TM-T70**

**The default line spacing except Japanese characters is about 4.23 mm {1/6 inch}, which is equivalent to 30 dots.**

**The default line spacing for Japanese characters is about 3.75 mm {30/203 inch}, which is equivalent to 30 dots.**

**When the maximum character height exceeds 30 dots in one line, printer feeds the paper amount of height of the character when changing lines in the standard mode.**

## **TM-T88IV**

The default line spacing is about 4.23 mm {1/6 inch}, which is equivalent to 30 dots.

When the maximum character height exceeds 30 dots in one line, the printer will feed the amount of paper equal to the height of the character when changing lines in standard mode.

## **TM-L90**

The default line spacing is about 3.75 mm (30/203 inch), which is equivalent to 30 dots.

When the maximum character height exceeds 30 dots in one line, the printer will feed the amount of paper equal to the height of the character when changing lines in standard mode.

## **TM-U230**

The default line spacing is about 4.23 mm {1/6 inch}, which is equivalent to 12 dots.

## **TM-U220**

The default line spacing is about 4.23 mm {1/6 inch}, which is equivalent to 12 dots.

## ESC 3

[Name]	Set line spacing
[Format]	ASCII      ESC 3 <b>n</b> Hex        1B 33 <b>n</b> Decimal    27 51 <b>n</b>
[Range]	$0 \leq n \leq 255$
[Default]	<b>TM-P60: n = 30</b> Printers other than the above: Amount of line spacing which corresponds to "default line spacing." (See <b>ESC 2</b> for the default line spacing.)
[Printers not featuring this command]	None
[Description]	Sets the line spacing to $n \times$ (vertical or horizontal motion unit).
[Notes]	<ul style="list-style-type: none"> <li>■ The maximum line spacing is 1016 mm {40 inches}. If the specified amount exceeds 1016 mm {40 inches}, the line spacing is automatically set to 1016 mm {40 inches}.</li> <li>■ When standard mode is selected, the vertical motion unit is used.</li> <li>■ When page mode is selected, the vertical or horizontal motion unit is used for the print direction set by <b>ESC T</b>.               <ul style="list-style-type: none"> <li>• When the starting position is set to the upper left or lower right of the print area using <b>ESC T</b>, the vertical motion unit is used.</li> <li>• When the starting position is set to the upper right or lower left of the print area using <b>ESC T</b>, the horizontal motion unit is used.</li> </ul> </li> <li>■ The line spacing can be set independently in standard mode and in page mode.               <ul style="list-style-type: none"> <li>• In standard mode this command sets the line spacing of standard mode.</li> <li>• In page mode this command sets the line spacing of page mode.</li> </ul> </li> <li>■ When the motion unit is changed after the line spacing is set, the line spacing setting does not change.</li> <li>■ Selected line spacing is effective until <b>ESC 2</b> is executed, <b>ESC @</b> is executed, the printer is reset, or the power is turned off.</li> </ul>

[Model-dependent variations]

**TM-J2000/J2100, TM-T90, TM-T70, TM-T88IV, TM-L90, TM-P60, TM-U230, TM-U220**

## Program example for ESC 2 and ESC 3

```

Program Example

PRINT #1, CHR$(&H1D); "P";CHR$(180);CHR$(180);
FOR n=25 TO 50 STEP 5
  PRINT #1, CHR$(&H1B);"3";CHR$(n); ←Set line spacing
  PRINT #1, "AAAAA"; CHR$(&HA);
NEXT n

PRINT #1, CHR$(&H1B);"2"; ←Set the default
PRINT #1, "BBBBB"; CHR$(&HA);
PRINT #1, "CCCCC"; CHR$(&HA);
    
```

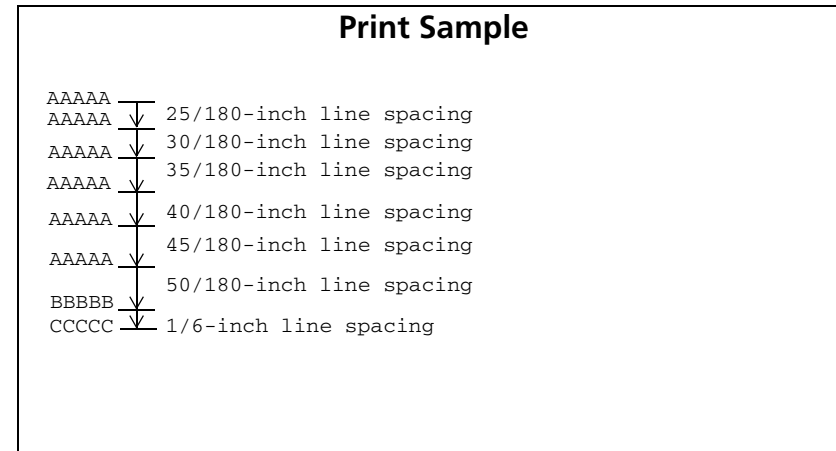

### TM-J2000/J2100

The vertical or horizontal motion unit is specified by **GS P**.

### TM-T90, TM-T70

The vertical or horizontal motion unit is specified by **GS P**.

In standard mode, if the character height is greater than the line spacing specified by this command, the paper is fed the amount of the character height. For example, if a line spacing of 30 dots is specified with this command, but the characters used are double height Font A (48 dots), the paper is fed 48 dots.

The amount of paper feed of the Japanese Kanji model can specify up to 900 mm {35.4 inches}. When the amount of paper feed which exceeds the maximum value is specified, the paper feed of the maximum amount is executed.

## **TM-T88IV**

The vertical or horizontal motion unit is specified by **GS P**.

In standard mode, if the character height is greater than the line spacing specified by this command, the paper is fed the amount of the character height. For example, if a line spacing of 30 dots is specified with this command, but the characters used are double height Font A (48 dots), the paper is fed 48 dots.

The amount of paper feed of the Japanese Kanji model can specify up to 900 mm {35.4 inches}. When the amount of paper feed which exceeds the maximum value is specified, the paper feed of the maximum amount is executed.

## **TM-L90**

The vertical or horizontal motion unit is specified by **GS P**.

In standard mode, if the character height is greater than the line spacing specified by this command, the paper is fed the amount of the character height. For example, if a line spacing of 30 dots is specified with this command, but the characters used are double height Font A (48 dots), the paper is fed 48 dots.

The amount of paper feed can specify up to 900 mm {35.4 inches}. When the amount of paper feed which exceeds the maximum value is specified, the paper feed of the maximum amount is executed.

## **TM-P60**

The vertical or horizontal motion unit is approximately 0.125 mm {1/203 inches}. This value equals one dot pitch.

In standard mode, if the character height is greater than the line spacing specified by this command, the paper is fed the amount of the character height. For example, if a line spacing of 30 dots is specified with this command, but the characters used are double height Font A (48 dots), the paper is fed 48 dots.

## **TM-U230**

The vertical motion unit is 0.176 mm {1/144 inch}. This value equals a half dot pitch. This command does not use the horizontal motion unit because this printer does not support page mode.

The default value is (n = 24).

## **TM-U220**

The vertical motion unit is 0.176 mm {1/144 inch}. This value equals a half dot pitch. This command does not use the horizontal motion unit because this printer does not support page mode.

The default value is (n = 24).



## CHARACTER COMMANDS

Command	Name
<b>CAN</b>	Cancel print data in page mode
<b>ESC SP</b>	Set right-side character spacing
<b>ESC !</b>	Select print mode(s)
<b>ESC %</b>	Select/cancel user-defined character set
<b>ESC &amp;</b>	Define user-defined characters
<b>ESC -</b>	Turn underline mode on/off
<b>ESC ?</b>	Cancel user-defined characters
<b>ESC E</b>	Turn emphasized mode on/off
<b>ESC G</b>	Turn double-strike mode on/off
<b>ESC M</b>	Select character font
<b>ESC R</b>	Select an international character set
<b>ESC V</b>	Turn 90° clockwise rotation mode on/off
<b>ESC r</b>	Select print color
<b>ESC t</b>	Select character code table
<b>ESC {</b>	Turn upside-down print mode on/off
<b>GS ( N</b>	Select character effects
	Select character color
	Select background color
	Turn shading mode on/off
<b>GS !</b>	Select character size
<b>GS B</b>	Turn white/black reverse print mode on/off
<b>GS b</b>	Turn smoothing mode on/off

## CAN

[Name] Cancel print data in page mode

[Format] ASCII      CAN  
Hex          18  
Decimal     24

[Range] None

[Default] None

[Printers not featuring this command] **TM-U230, TM-U220**

[Description] In page mode, deletes all the print data in the current print area.

- [Notes]
- This command is enabled only in page mode. Page mode is selected by **ESC L**.
  - If data set in the previously specified print area is set in the currently specified print area, it is deleted.

[Model-dependent variations] None

### Program Example for all printers

```
PRINT #1, CHR$(&H1B);"L"; ←Select page mode
PRINT #1, CHR$(&H1D);"P";CHR$(180);CHR$(180);
PRINT #1, CHR$(&H1B);"W";CHR$(0);CHR$(0);CHR$(0);
CHR$(0);CHR$(240);CHR$(0);CHR$(44);CHR$(1);
PRINT #1, CHR$(&H1B);"T";CHR$(0); ←Select print direction
FOR i=1 TO 200 : PRINT #1, "A" : : NEXT i
PRINT #1, CHR$(&H1B);"W";CHR$(60);CHR$(0);CHR$(90);
CHR$(0);CHR$(60);CHR$(0);CHR$(120);CHR$(0);
PRINT #1, CHR$(&H18); ←Cancel print data
PRINT #1, CHR$(&HC); ←Batch print and return to standard mode
```

### Print Sample

```
AAAAAAAAAAAAAAAAAAAAA
AAAAAAAAAAAAAAAAAAAAA
AAAAAAAAAAAAAAAAAAAAA
AAAAA      AAAAAAAAAA
AAAAA      AAAAAAAAAA
AAAAA      AAAAAAAAAA
AAAAA      AAAAAAAAAA
AAAAAAAAAAAAAAAAAAAAA
AAAAAAAAAAAAAAAAAAAAA
AAAAAAAAAAAAAAAAAAAAA
```

## ESC SP

[Name] Set right-side character spacing

[Format] ASCII      ESC SP   **n**  
 Hex        1B 20   **n**  
 Decimal    27 32   **n**

[Range]  $0 \leq n \leq 255$

[Default] **n** = 0

[Printers not featuring this command] None

[Description] Sets the right-side character spacing to **n** × (horizontal or vertical motion unit).

- [Notes]
- The character spacing set by this command is effective for alphanumeric, Kana, and user-defined characters.
  - When characters are enlarged, the character spacing is **n** times normal value. The character spacing for double-width mode is twice the normal value.
  - When standard mode is selected, the horizontal motion unit is used.
  - When page mode is selected, the vertical or horizontal motion unit is used for the print direction set by **ESC T**.
    - When the starting position is set to the upper left or lower right of the print area using **ESC T**, the horizontal motion unit is used.
    - When the starting position is set to the upper right or lower left of the print area using **ESC T**, the vertical motion unit is used.
  - The character spacing can be set independently in standard mode and in page mode.
    - In standard mode this command sets the character spacing of standard mode.
    - In page mode this command sets the character spacing of page mode.
  - If the horizontal or vertical motion unit is changed after this command is executed, the character spacing is not changed.
  - Settings of this command are effective until **ESC @** is executed, the printer is reset, or the power is turned off.

# CONFIDENTIAL

- It is used to change the spacing between characters.

[Model-dependent variations]

**TM-J2000/J2100**, **TM-T90**, **TM-T88IV**, **TM-T70**, **TM-L90**, **TM-P60**, **TM-U230**,  
**TM-U220**

## Program Example for all printers

```
PRINT #1, CHR$( &H1D); "P"; CHR$(180); CHR$(180);  
PRINT #1, CHR$( &H1B); " "; CHR$(0); ←Character spacing set to 0  
PRINT #1, "AAAAA"; CHR$( &HA);  
PRINT #1, CHR$( &H1B); " "; CHR$(6); ←Character spacing set to 6  
PRINT #1, "BBBBB"; CHR$( &HA);  
PRINT #1, CHR$( &H1B); " "; CHR$(12); ←Character spacing set to 12  
PRINT #1, "CCCCC"; CHR$( &HA);
```

## Print Sample

```
AAAAA ← 0-inch character spacing  
BBBBB ← 6/180-inch character spacing  
CCCCC ← 12/180-inch character spacing
```

**TM-J2000/J2100**, **TM-T90**, **TM-T88IV**, **TM-T70**, **TM-L90**

The vertical or horizontal motion unit is specified by **GS P**.

## TM-P60

The horizontal or vertical motion unit is approximately 0.125 mm {1/203 inches}. This value equals one dot pitch.

## TM-U230

The horizontal motion unit is 0.159 mm {1/160 inch}. This value equals a half dot pitch. This command does not use the vertical motion unit because the printer does not support page mode.

## TM-U220

The horizontal motion unit is 0.159 mm {1/160 inch}. This value equals a half dot pitch. This command does not use the vertical motion unit because the printer does not support page mode.

## ESC !

[Name] Select print mode(s)

[Format] ASCII    ESC !    **n**  
 Hex        1B 21    **n**  
 Decimal    27 33    **n**

[Range]  $0 \leq n \leq 255$

[Default] **TM-J2000/J2100, TM-T90, TM-T88IV, TM-T70, TM-L90: n = 0**  
**TM-U230, TM-U220: n = 1**

[Printers not featuring this command] **TM-P60**

[Description] Selects the character font and styles (emphasized, double-height, double-width, and underline) together as follows:

<b>n: Bit</b>	<b>Off/On</b>	<b>Hex</b>	<b>Decimal</b>	<b>Function</b>
0	Off	00	0	Character font 1 selected.
	On	01	1	Character font 2 selected.
1, 2	—	—	—	Undefined.
3	Off	00	0	Emphasized mode is turned off.
	On	08	8	Emphasized mode is turned on.
4	Off	00	0	Double-height canceled.
	On	10	16	Double-height selected.
5	Off	00	0	Double-width canceled.
	On	20	32	Double-width selected.
6	—	—	—	Undefined.
7	Off	00	0	Underline mode is turned off.
	On	80	128	Underline mode is turned on.

*... how to use  
this table*

[Notes]

- Settings of this command are effective until ESC @ is executed, the printer is reset, the power is turned off, or one of the following commands is executed:
  - Bit 0 (character font): **ESC M**
  - Bit 3 (Emphasized mode): **ESC E**
  - Bit 4, 5 (character size): **GS !**
  - Bit 7 (underline mode): **ESC -**
- Configurations of Font 1 and Font 2 are different, depending on the printer model. If the desired font type cannot be selected with this command, use **ESC M**.
- The print modes set by this command (Bit 0, 4, 5 and 7) are effective for alphanumeric, Kana, and user-defined characters.
- The emphasized print modes set by this command (Bit 3) are effective for alphanumeric, Kana, multilingual, and user-defined characters.
- When some characters in a line are double-height, all characters on the line are aligned at the baseline.
- When double-width mode is turned on, the characters are enlarged to the right, based on the left side of the character.
- When both double-height and double-width modes are turned on, quadruple size characters are printed.
- In standard mode, the character is enlarged in the paper feed direction when double-height mode is selected, and it is enlarged perpendicular to the paper feed direction when double-width mode is selected. However, when character orientation changes in 90° clockwise rotation mode, the relationship between double-height and double-width is reversed.
- In page mode, double-height and double-width are on the character orientation.
- The underline thickness is that specified by **ESC -**, regardless of the character size. The underline is the same color as the printed character. The printed character's color is specified by **GS ( N <Function 48>**.
- When underline mode is turned on, 90° clockwise-rotated characters and white/black reverse characters cannot be underlined.
- The printer cannot underline the space set by **HT**, **ESC \$**, and **ESC \**.

# CONFIDENTIAL

[Model-dependent variations]

**TM-J2000/J2100, TM-T90, TM-T88IV, TM-T70, TM-L90, TM-U230, TM-U220**

## Program Example for all printers

```
PRINT #1, CHR$(&H1B);"!";CHR$(0); "AA";  
PRINT #1, CHR$(&H1B);"!";CHR$(8); "BB";  
PRINT #1, CHR$(&H1B);"!";CHR$(16); "CC";  
PRINT #1, CHR$(&H1B);"!";CHR$(24); "DD";  
PRINT #1, CHR$(&H1B);"!";CHR$(32); "EE";  
PRINT #1, CHR$(&H1B);"!";CHR$(40); "FF";  
PRINT #1, CHR$(&H1B);"!";CHR$(48); "GG";  
PRINT #1, CHR$(&H1B);"!";CHR$(56); "HH"; CHR$(&HA);  
PRINT #1, CHR$(&H1B);"!";CHR$(129); "AA";  
PRINT #1, CHR$(&H1B);"!";CHR$(137); "BB";  
PRINT #1, CHR$(&H1B);"!";CHR$(145); "CC";  
PRINT #1, CHR$(&H1B);"!";CHR$(153); "DD";  
PRINT #1, CHR$(&H1B);"!";CHR$(161); "EE";  
PRINT #1, CHR$(&H1B);"!";CHR$(169); "FF";  
PRINT #1, CHR$(&H1B);"!";CHR$(177); "GG";  
PRINT #1, CHR$(&H1B);"!";CHR$(185); "HH"; CHR$(&HA);
```

## Print Sample

AABBCCDD EEEFFGGHH ← Font A  
AABBCCDD EEEFFGGHH ← Font B  
with underline

AA: Normal  
BB: Emphasized  
CC: Double-height  
DD: Emphasized + Double-height  
EE: Double-width  
FF: Emphasized + Double-width  
GG: Double-height + Double-width  
HH: Emphasized + Double-height + Double-width

## **TM-J2000/J2100, TM-T90, TM-L90**

[Other than Japanese Kanji model]

### Character configurations

**Bit 0: Font 1 = Font A (12 × 24)**  
**Font 2 = Font B (9 × 17)**

Each character's baseline is as follows:

**Font A (12 × 24): 21 dots from the top of a character.**  
**Font B (9 × 17): 16 dots from the top of a character.**

[Japanese model]

**Bit 0: Font 1 = Font A: 12 × 24**  
**Font 2 = Font C: 8 × 16**

# CONFIDENTIAL

Each character's baseline is as follows.

Font A (12 × 24): 21 dots from the top of a character.

Font C (8 × 16): 15 dots from the top of a character.

Font B (12 × 24) can be selected by ESC M.

## TM-T88IV

Character configurations

Bit 0: Font 1 = Font A (12 × 24)

Font 2 = Font B (9 × 17)

Each character's baseline is as follows:

Font A (12 × 24): 21 dots from the top of a character.

Font B (9 × 17): 16 dots from the top of a character.

## TM-T70

[Other than Japanese model]

Character configurations

Bit 0: Font 1 = Font A (12 × 24)

Font 2 = Font B (9 × 17)

Each character's baseline is as follows:

Font A (12 × 24): 21 dots from the top of a character.

Font B (9 × 17): 16 dots from the top of a character.

[Japanese model]

Bit 0: Font 1 = Font A: 12 × 24

Font 2 = Font B: 8 × 16

Each character's baseline is as follows:

Font A (12 × 24): 21 dots from the top of a character.

Font B (8 × 16): 15 dots from the top of a character.



# C O N F I D E N T I A L

## TM-U230, TM-U220

### Character configurations

**Bit 0:**    **Font 1 = Font A (9 × 9)**

**Font 2 = Font B (7 × 9)**

**Both fonts have no baseline.**

## ESC %

[Name] Select/cancel user-defined character set

[Format] ASCII    ESC %   **n**  
 Hex        1B 25   **n**  
 Decimal    27 37   **n**

[Range]  $0 \leq n \leq 255$

[Default] **n** = 0

[Printers not featuring this command] **TM-P60**

[Description] Selects or cancels the user-defined character set.

- When the LSB of **n** is 0, the user-defined character set is canceled.
- When the LSB of **n** is 1, the user-defined character set is selected.

[Notes] ■ When the user-defined character set is canceled, the resident character set is automatically selected.  
 ■ Settings of this command are effective until **ESC @** is executed, the printer is reset, or the power is turned off.

[Model-dependent variations]            None

**See program example and print sample for ESC %, ESC &, and ESC ?.**

## ESC &

[Name]	Define user-defined characters		
[Format]	ASCII	ESC &	<b>y c1 c2 [x1 d1 ... d(y × x1)] ... [xk d1 ... d(y × xk)]</b>
	Hex	1B 26	<b>y c1 c2 [x1 d1 ... d(y × x1)] ... [xk d1 ... d(y × xk)]</b>
	Decimal	27 38	<b>y c1 c2 [x1 d1 ... d(y × x1)] ... [xk d1 ... d(y × xk)]</b>
[Range]	<b>TM-J2000/J2100, TM-T90, TM-L90:</b>		
	<b>[Other than Japanese model]</b>		
	<b>y = 3</b>		
	<b>32 ≤ c1 ≤ c2 ≤ 126</b>		
	<b>0 ≤ x ≤ 12 (Font A (12 × 24))</b>		
	<b>0 ≤ x ≤ 9 (Font B (9 × 17))</b>		
	<b>0 ≤ d ≤ 255</b>		
	<b>k = c2 - c1 + 1</b>		
	<b>[Japanese model]</b>		
	<b>y = 3 (Font A (12 × 24)/Font B (10 × 24))</b>		
	<b>y = 2 (Font C (8 × 16))</b>		
	<b>32 ≤ c1 ≤ c2 ≤ 126</b>		
	<b>0 ≤ x ≤ 12 (Font A (12 × 24))</b>		
	<b>0 ≤ x ≤ 10 (Font B (10 × 24))</b>		
	<b>0 ≤ x ≤ 8 (Font C (8 × 16))</b>		
	<b>0 ≤ d ≤ 255</b>		
	<b>k = c2 - c1 + 1</b>		
	<b>TM-T88IV:</b>		
	<b>y = 3</b>		
	<b>32 ≤ c1 ≤ c2 ≤ 126</b>		
	<b>0 ≤ x ≤ 12 (Font A (12 × 24))</b>		
	<b>0 ≤ x ≤ 9 (Font B (9 × 17))</b>		
	<b>0 ≤ d ≤ 255</b>		
	<b>k = c2 - c1 + 1</b>		
	<b>TM-T70:</b>		
	<b>[Other than Japanese model]</b>		
	<b>y = 3</b>		
	<b>32 ≤ c1 ≤ c2 ≤ 126</b>		
	<b>0 ≤ x ≤ 12 (Font A (12 × 24))</b>		

$0 \leq x \leq 9$  (Font B (9 × 17))

$0 \leq d \leq 255$

$k = c2 - c1 + 1$

[Japanese model]

$y = 3$  (Font A (12 × 24))

$y = 2$  (Font B (8 × 16))

$32 \leq c1 \leq c2 \leq 126$

$0 \leq x \leq 12$  (Font A (12 × 24))

$0 \leq x \leq 8$  (Font B (8 × 16))

$0 \leq d \leq 255$

$k = c2 - c1 + 1$

**TM-U230, TM-U220:**

$y = 2$

$32 \leq c1 \leq c2 \leq 126$

$0 \leq x \leq 12$  (Font A (9 × 9))

$0 \leq x \leq 10$  (Font B (7 × 9))

$0 \leq d \leq 255$

$k = c2 - c1 + 1$

[Default] None

[Printers not featuring this command] **TM-P60**

[Description] Defines the user-defined character pattern for the specified character codes.

- **y** specifies the number of bytes in the vertical direction.
- **c1** specifies the beginning character code for the definition, and **c2** specifies the final code.
- **x** specifies the number of dots in the horizontal direction from the left.
- **d** specifies the defined data (column format).
- **k** indicates the number of defined data. **k** is an explanation parameter; therefore it does not need to be transmitted.

**[Notes]** ■ Character codes from the alphanumeric characters in Hexadecimal: 20H to 7EH / in Decimal: 32 to 126 can be defined.

# CONFIDENTIAL

- Data (**d**) specifies a bit printed to 1 and not printed to 0. The dot pattern is in the horizontal direction from the left side. Any remaining dots on the right side are blank.
- The data to define a user-defined character is (**y** × **x**) bytes.
- When the value of **y**, **c1**, **c2**, or **x** is out of the range, this command is canceled, and the following data is processed as normal data.
- This command can define user-defined characters for each font independently. To select a font, use **ESC !** or **ESC M**.

- A user-defined character, downloaded graphics, and downloaded bit image cannot be defined simultaneously on some printer models.
  - When this command is executed, the downloaded bit image is cleared.
  - When **GS ( L** <Function 83> <Function 84> or **GS \*** is executed, the user-defined character data is cleared.
- Once the user-defined characters have been defined, they are available until **ESC ?**, **GS \***, or **ESC @** is executed; the user-defined characters are redefined; the power is turned off; or the printer is reset.
- The user-defined characters are not defined at the default, and the resident characters are printed.
- The relationship between the definition data and printing result is as follows.  
Example: Downloaded character definition consists of  $9 \times 7$  dots.

<b>d1</b>	<b>d3</b>	<b>d5</b>	<b>d7</b>	<b>d9</b>	<b>d11</b>	<b>d13</b>	MSB
							LSB
<b>d2</b>	<b>d4</b>	<b>d6</b>	<b>d8</b>	<b>d10</b>	<b>d12</b>	<b>d14</b>	MSB
							LSB

[Model-dependent variations]

**TM-J2000/J2100**, **TM-T90**, **TM-T88IV**, **TM-T70**, **TM-L90**, **TM-U230**, **TM-U220**

See program example and print sample for **ESC %**, **ESC &**, and **ESC ?**.

## TM-J2000/J2100

Only the MSB can be printed in the third byte for vertical direction of Font B of other than Japanese model. A user-defined character, downloaded graphics, and downloaded bit image cannot be defined simultaneously.

## TM-T90

Only the MSB can be printed in the third byte for vertical direction of Font B of other than Japanese model. Expect for the Japanese Kanji model, a user-defined character and downloaded bit image cannot be defined simultaneously when the memory switch 8-7 is ON. See Function 3 of **GS ( E** for the memory switch.

## **TM-T88IV**

**Only the MSB can be printed in the third byte for vertical direction of Font B. A user-defined character and downloaded bit image cannot be defined simultaneously.**

## **TM-T70**

**Only the MSB can be printed in the third byte for vertical direction of Font B of models other than Japanese model. A user-defined character and downloaded bit image cannot be defined simultaneously.**

## **TM-L90**

**Only the MSB can be printed in the third byte for vertical direction of Font B of other than Japanese model.**

## **TM-U230**

**The dots adjoining each other horizontally cannot be printed. Only the MSB can be printed in the second byte for vertical direction.**

**The maximum number of user-defined characters is 19.**

## **TM-U220**

**The dots adjoining each other horizontally cannot be printed. Only the MSB can be printed in the second byte for vertical direction.**

**The maximum number of user-defined characters is 20.**

## ESC –

[Name] Turn underline mode on/off

[Format] ASCII ESC – **n**  
 Hex 1B 2D **n**  
 Decimal 27 45 **n**

[Range] **TM-J2000/J2100, TM-T90, TM-T88IV, TM-T70, TM-L90, TM-P60, TM-U220: 0 ≤ n ≤ 2, 48 ≤ n ≤ 50**  
**TM-U230: n = 0, 1, 48, 49**

[Default] **n = 0**

[Printers not featuring this command] None

[Description] Turns underline mode on or off using **n** as follows:

<b>n</b>	<b>Function</b>
0, 48	Turns off underline mode
1, 49	Turns on underline mode (1-dot thick)
2, 50	Turns on underline mode (2-dots thick)

- [Notes]
- The underline mode is effective for alphanumeric, Kana, and user-defined characters.
  - When underline mode is turned on, 90° clockwise rotated characters and white/black reverse characters cannot be underlined.
  - The color of underline is the same as that of the printing character. The printing character's color is selected by **GS ( N <Function 48>**.
  - The printer cannot underline the space set by **HT, ESC \$, and ESC \**.
  - Changing the character size does not affect the current underline thickness.
  - When underline mode is turned off, the following data cannot be underlined, but the thickness is maintained.
  - This command and bit 7 of **ESC !** turn on and off underline mode in the same way.
  - Some of the printer models support the 2-dot thick underline (**n = 2 or 5**).



# CONFIDENTIAL

[Model-dependent variations]

## TM-U220

### Program Example for all printers

```
PRINT #1, CHR$(&H1B); "-" ; CHR$(1); ← Select  
PRINT #1, "AAAAA"; CHR$(&HA);  
PRINT #1, CHR$(&H1B); "-" ; CHR$(0); ← Cancel  
PRINT #1, "BBBBB"; CHR$(&HA);
```

### Print Sample

```
AAAAA ← Underline (1-dot thick) turned on  
BBBBB ← Underline turned off
```

## TM-U220

**When (n = 1, 2, 49, 50), this command specifies the underline mode (1 dot thick).**

## ESC ?

SETTING COMMAND

[Name] Cancel user-defined characters

[Format] ASCII ESC ? **n**  
 Hex 1B 3F **n**  
 Decimal 27 63 **n**

[Range]  $32 \leq n \leq 126$

[Default] None

[Printers not featuring this command] **TM-P60**

[Description] Deletes the user-defined character pattern specified by character code **n**.

- [Notes]
- After the user-defined characters are canceled, the resident character set is printed.
  - This command can cancel user-defined characters for each font independently. To select a font, use **ESC !** or **ESC M**.

[Model-dependent variations] None

**See program example and print sample for ESC %, ESC &, and ESC ?.**

# CONFIDENTIAL

## Program example for ESC %, ESC &, and ESC ?

### Program Example

```
PRINT #1, CHR$(&H1B); "&"; CHR$(2); "AC";
PRINT #1, CHR$(9);
FOR i=1 TO 2*9
  READ d: PRINT #1, CHR$(d);
NEXT i
PRINT #1, CHR$(9);
FOR i=1 TO 2*9
  READ d: PRINT #1, CHR$(d);
NEXT i
PRINT #1, CHR$(10);
FOR i=1 TO 2*10
  READ d: PRINT #1, CHR$(d);
NEXT i
PRINT #1, CHR$(&H1B); "%"; CHR$(0); ← Select resident character
PRINT #1, "A B C D E"; CHR$(&HA);
PRINT #1, CHR$(&H1B); "%"; CHR$(1); ← Select user-defined character
PRINT #1, "A B C D E"; CHR$(&HA);
PRINT #1, CHR$(&H1B); "?"; "A"; ← Cancel the user-defined character
PRINT #1, "A B C D E"; CHR$(&HA);
```

### Program Example (continued)

```
DATA &H18, &H00, &H00, &H00, &H3C, &H00, &H00, &H00
DATA &H7E, &H00, &H00, &H00, &H3C, &H00, &H00, &H00
DATA &H18, &H00
DATA &H18, &H00, &H00, &H00, &H24, &H00, &H00, &H00
DATA &H42, &H00, &H00, &H00, &H24, &H00, &H00, &H00
DATA &H18, &H00
DATA &H00, &H00, &H10, &H00, &H20, &H00, &H5F, &H00
DATA &H00, &H00, &H81, &H00, &H00, &H00, &H5F, &H00
DATA &H20, &H00, &H10, &H00
```

### Print Sample

```
A B C D E ← Characters from resident character set
◆◊◊ D E ← Characters from user-defined character set
A ◊◊ D E ← Characters from user-defined character set (cancel one character)
```

## ESC E

[Name] Turn emphasized mode on/off

[Format]            ASCII        ESC E    **n**  
                   Hex         1B 45    **n**  
                   Decimal    27 69    **n**

[Range]             $0 \leq n \leq 255$

[Default]           **n = 0**

[Printers not featuring this command] None

[Description]      Turns emphasized mode on or off.

- When the LSB of **n** is 0, emphasized mode is turned off.
- When the LSB of **n** is 1, emphasized mode is turned on.

[Notes]            ■ This mode is effective for alphanumeric, Kana, multilingual, and user-defined characters.

                  ■ The settings of this command are effective until **ESC !** is executed, **ESC @** is executed, the printer is reset, or the power is turned off.

[Model-dependent variations]      **TM-U230, TM-U220**

### Program Example for all printers

```
PRINT #1, CHR$(&H1B);"E";CHR$(1); ←Select
PRINT #1, "AAAAA"; CHR$(&HA);
PRINT #1, CHR$(&H1B);"E";CHR$(0); ←Cancel
PRINT #1, "BBBBB"; CHR$(&HA);
```

### Print Sample

```
AAAAA ← Emphasized
BBBBB ← Normal
```

### TM-U220, TM-U230

**Print speed is slow when emphasized mode on because this printer prints with 2 passes in this mode.**

## ESC G

[Name] Turn double-strike mode on/off

[Format] ASCII ESC G **n**  
 Hex 1B 47 **n**  
 Decimal 27 71 **n**

[Range]  $0 \leq n \leq 255$

[Default] **n = 0**

[Printers not featuring this command] **TM-P60**

[Description] Turns double-strike mode on or off.

- When the LSB of **n** is 0, double-strike mode is turned off.
- When the LSB of **n** is 1, double-strike mode is turned on.

[Notes] ■ The double-strike mode is effective for alphanumeric, Kana, multilingual, and user-defined characters.

[Model-dependent variations] **TM-U230, TM-U220**

### Program Example for all printers

```
PRINT #1, CHR$(&H1B); "G"; CHR$(1); ← Select
PRINT #1, "AAAAA"; CHR$(&HA);
PRINT #1, CHR$(&H1B); "G"; CHR$(0); ← Cancel
PRINT #1, "BBBBB"; CHR$(&HA);
```

### Print Sample

```
AAAAA ← Double-strike
BBBBB ← Normal
```

### **TM-U220, TM-U230**

**Print speed is slow when double-strike mode on because this printer prints with 2 passes in this mode.**

## ESC M

[Name] Select character font

[Format] ASCII    ESC M   **n**  
 Hex        1B 4D   **n**  
 Decimal    27 77   **n**

[Range] **TM-J2000/J2100, TM-T90, TM-L90:**  
           **n = 0, 1, 48, 49 (Other than Japanese model)**  
           **0 ≤ n ≤ 2, 48 ≤ n ≤ 50 (Japanese model)**  
**TM-T88IV, TM-T70, TM-U220: n = 0, 1, 48, 49**  
**TM-P60:**  
           **0 ≤ n ≤ 2, 48 ≤ n ≤ 50, n = 97 (Peeler model)**  
           **0 ≤ n ≤ 2, 48 ≤ n ≤ 50 (Other than peeler model)**

[Default] **TM-J2000/J2100, TM-T90, TM-T88IV, TM-T70, TM-L90: n = 0**  
**TM-P60, TM-U220: n = 1**

[Printers not featuring this command] **TM-U230**

[Description] Selects a character font, using **n** as follows:

<b>n</b>	<b>Font</b>
0, 48	Font A
1, 49	Font B
2,50	Font C
97	Extended font

- [Notes]
- The character font set by this command is effective for alphanumeric, Kana, and user-defined characters.
  - Configurations of Font A and Font B depend on the printer model.
  - The settings of this command are effective until **ESC !** is executed, **ESC @** is executed, the printer is reset, or the power is turned off.

[Model-dependent variations]

**TM-J2000/J2100, TM-T90, TM-T88IV, TM-T70, TM-L90, TM-P60, TM-U220**

## Program Example for all printers

```
PRINT #1, CHR$(&H1B); "M"; CHR$(0); ←Select font A
PRINT #1, "AAAAA"; CHR$(&HA);
PRINT #1, CHR$(&H1B); "M"; CHR$(1); ←Select font B
PRINT #1, "BBBBB"; CHR$(&HA);
```

## Print Sample

```
AAAAA ←Font A
BBBBB ←Font B
```

## **TM-J2000/J2100, TM-T90, TM-L90**

### [Other than Japanese model]

#### Character configurations

**Font A: (12 × 24)**

**Font B: (9 × 17)**

#### Each character's baseline is as follows:

**Font A (12 × 24): 21 dots from the top of a character.**

**Font B (9 × 17): 16 dots from the top of a character.**

### [Japanese model]

#### Character configurations

**Font A: (12 × 24)**

**Font B: (10 × 24)**

**Font C: (8 × 16)**

#### Each character's baseline is as follows:

**Font A (12 × 24): 21 dots from the top of a character.**

**Font B (10 × 24): 21 dots from the top of a character.**

**Font C (8 × 16): 15 dots from the top of a character.**

## TM-T88IV

### Character configurations

Font A: (12 × 24)

Font B: (9 × 17)

### Each character's baseline is as follows:

Font A (12 × 24): 21 dots from the top of a character.

Font B (9 × 17): 16 dots from the top of a character.

## TM-T70

### [Other than Japanese model]

### Character configurations

Font A: (12 × 24)

Font B: (9 × 17)

### Each character's baseline is as follows:

Font A (12 × 24): 21 dots from the top of a character.

Font B (9 × 17): 16 dots from the top of a character.

### [Japanese model]

### Character configurations

Font A: (12 × 24)

Font B: (8 × 16)

### Each character's baseline is as follows:

Font A (12 × 24): 21 dots from the top of a character.

Font B (8 × 16): 15 dots from the top of a character.



## TM-P60

[Peeler model]

### Character configurations

Font A: (12 × 24)

Font B: (10 × 24)

Font C: (8 × 16)

Extended font (Special font: 24 × 48)

Each character's baseline is as follows:

Font A (12 × 24): 21 dots from the top of a character.

Font B (10 × 24): 21 dots from the top of a character.

Font C (8 × 16): 15 dots from the top of a character.

Special font (24 × 48): The 42nd dot from the top edge of the character

Special fonts (24 × 48) have the following restrictions.

The resident character types are as follows.

Character type	Number of characters	Character code
Alphanumeric characters	96 characters	Hexadecimal = 20H to 7FH / Decimal = 32 to 127
Extended graphics	128 characters × 1 page	Hexadecimal = 80H to FFH / Decimal = 128 to 255

This printer has only character code table [Page 0]. (see **ESC t**)

This printer has only international character set [USA]. (see **ESC R**)

Character size enlargement of [width: times 1 to times 4/height: times 1 to times 4] is possible. (see **GS !**)

The user-defined character function is not supported.

# CONFIDENTIAL

**[Other than peeler model]**

**Character configurations**

**Font A: (12 × 24)**

**Font B: (10 × 24)**

**Font C: (8 × 16)**

**Each character's baseline is as follows:**

**Font A (12 × 24): 21 dots from the top of a character.**

**Font B (10 × 24): 21 dots from the top of a character.**

**Font C (8 × 16): 15 dots from the top of a character.**

## **TM-U220**

**Character configurations**

**Font A (9 × 9)**

**Font B (7 × 9)**

**Both fonts have no baseline.**

## ESC R

[Name] Select an international character set

[Format] ASCII      ESC R    **n**  
 Hex        1B 52    **n**  
 Decimal    27 82    **n**

[Range] **TM-J2000/J2100, TM-T90, TM-L90, TM-U230: 0 ≤ n ≤ 13**  
**TM-T88IV, TM-T70, TM-P60, TM-U220: 0 ≤ n ≤ 15**

[Default] **TM-J2000/J2100, TM-T90, TM-L90, TM-U230: n = 0**  
**TM-T88IV: n = 15 (Simplified Chinese model)**  
**n = 0 (Other than the Simplified Chinese model)**  
**TM-T70, TM-P60: n = 8 [Japanese model]**  
**n = 0 [Other than the Japanese model]**  
**TM-U220: n = 0 (Other than the Simplified Chinese model or Simplified Chinese model with GB18030 not selected)**  
**n = 15 (Simplified Chinese model with GB18030 selected)**

[Description] Selects an international character set **n** as follows:

<b>n</b>	<b>Country</b>
0	U.S.A.
1	France
2	Germany
3	U.K.
4	Denmark I
5	Sweden
6	Italy
7	Spain
8	Japan
9	Norway

# CONFIDENTIAL

n	Country
10	Denmark II
11	Spain II
12	Latin America
13	Korean
14	Slovenia / Croatia
15	Chinese

[Notes] ■ The selected international character set is effective until **ESC @** is executed, the printer is reset, or the power is turned off.

[Model-dependent variations] **TM-P60, TM-U220**

```

Program Example for all printers

FOR n=0 TO 10
  PRINT #1, CHR$( &H1B ); "R"; CHR$( n );
  PRINT #1, "# $ @ [ \ ] ^ ` { | } ~"; CHR$( &HA );
NEXT n
    
```

```

Print Sample

# $ @ [ \ ] ^ ` { | } ~ ← n=0 (Default setting)
# $ à ° ç $ ^ ` é ù è ~ ← n=1
# $ s Ä ö Ü ^ ` ä ø ù Æ ← n=2
£ $ @ [ \ ] ^ ` { | } ~ ← n=3
# $ @ æ ø Å ^ ` æ ø å ~ ← n=4
# ¢ É Ä Ö Å Û é ä ö å ü ← n=5
# $ @ ° \ é ^ ù à ò è ì ← n=6
π $ @ ; Ñ ¿ ^ ` " ñ } ~ ← n=7
# $ @ [ ¥ ] ^ ` { | } ~ ← n=8
# ¢ É æ ø Å Û é æ ø å ü ← n=9
# $ É æ ø Å Û é æ ø å ü ← n=10
    
```

## TM-P60

**Settings of this command do not affect special font (24 × 48) printing. Special fonts (24 × 48) print characters when USA is selected, irrespective of the settings of this command.**

## TM-U220

**The character code table (GB18030 / GB2312) of Simplified Chinese model is selected by using Memory switch {Msw2-3}. See **GS ( E <Function 3>** for details on the Memory switch.**

## ESC V

[Name] Turn 90° clockwise rotation mode on/off

[Format] ASCII ESC V **n**  
 Hex 1B 56 **n**  
 Decimal 27 86 **n**

[Range]  $0 \leq n \leq 2, 48 \leq n \leq 50$

[Default] **n** = 0

[Printers not featuring this command] **TM-T70**, **TM-P60**, **TM-U230**, **TM-U220**

[Description] In standard mode, turns 90° clockwise rotation mode on or off for characters, using **n** as follows:

<b>n</b>	<b>Function</b>
0, 48	Turns off 90° clockwise rotation mode.
1, 48	Turns on 90° clockwise rotation mode (1-dot character spacing).
2, 50	Turns on 90° clockwise rotation mode (1.5-dot character spacing).

- [Notes]
- The 90° clockwise rotation mode is effective for alphanumeric, Kana, multilingual, and user-defined characters.
  - When underline mode is turned on, the printer does not underline 90° clockwise-rotated characters.
  - When character orientation changes in 90° clockwise rotation mode, the relationship between vertical and horizontal directions is reversed.
  - The 90° clockwise rotation mode has no effect in page mode. If this command is processed in page mode, an internal flag is activated, and this flag is enabled when the printer returns to standard mode.
  - Some printer models support 90° clockwise rotation mode when **n** = 2 or 50.
  - Some printer models have a font for which 90° clockwise rotation mode is not effective.
  - The settings of this command are effective until **ESC @** is executed, the printer is reset, or the power is turned off.

[Model-dependent variations]

**TM-J2000/J2100, TM-T90, TM-T88IV, TM-L90**

```

Program Example for all printers

PRINT #1, CHR$(&H1D);"P";CHR$(180);CHR$(180);
PRINT #1, CHR$(&H1B);" ";CHR$(20);←Set character spacing
PRINT #1, CHR$(&H1B);"3";CHR$(15);←Set line spacing
PRINT #1, CHR$(&H1B);"V";CHR$(1);←Select
  PRINT #1, "AAAAA"; CHR$(&HA);
  PRINT #1, "BBBBB"; CHR$(&HA);
  PRINT #1, "CCCCC"; CHR$(&HA);
PRINT #1, CHR$(&H1B);"2";←Set line spacing
PRINT #1, CHR$(&H1B);"V";CHR$(0);←Cancel
  PRINT #1, "AAAAA"; CHR$(&HA);
  PRINT #1, "BBBBB"; CHR$(&HA);
  PRINT #1, "CCCCC"; CHR$(&HA);
    
```

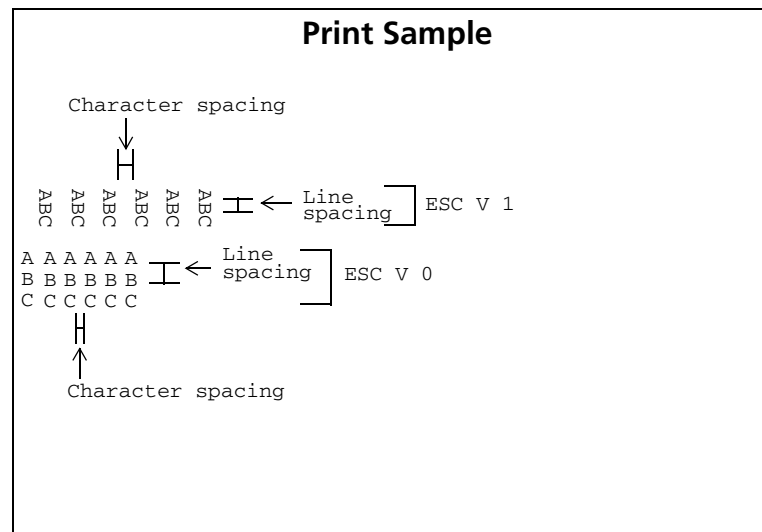

**TM-J2000/J2100, TM-T90, TM-T88IV, TM-L90**

**These printers don't support the 90° clockwise rotation mode (1.5-dot character spacing). The printer models use n as follows.**

<b>n</b>	<b>Function</b>
<b>0, 48</b>	<b>Turns off 90° clockwise rotation mode.</b>
<b>1, 48 2, 50</b>	<b>Turns on 90° clockwise rotation mode (1-dot character spacing).</b>

## ESC r

[Name] Select print color

[Format] ASCII ESC r **n**  
 Hex 1B 72 **n**  
 Decimal 27 114 **n**

[Range] **n** = 0, 1, 48, 49

[Default] **n** = 0

[Printers not featuring this command] **TM-J2000**, **TM-T90**, **TM-T88IV**, **TM-T70**, **TM-L90**, **TM-P60**

[Description] Selects a print color, using **n** as follows:

<b>n</b>	<b>Print color</b>
0, 48	Black
1, 49	Red

- [Notes]
- When standard mode is selected, this command is enabled only when processed at the beginning of the line.
  - When page mode is selected, the color setting is the same for all data collectively printed by **FF** or **ESC FF**.
  - This command is effective until **ESC @** is executed, the printer is reset, or the power is turned off.
  - **GS ( N** and **GS ( L** are available to define two-color printing. It is recommended that the commands shown below be used with the models that feature these commands.

<b>Printing data</b>	<b>Command &lt;Function&gt;</b>
Character	<b>GS ( N</b> <Function48>
Background	<b>GS ( N</b> <Function49>
Graphics	<b>GS ( L</b> <Function50> <Function112> <Function113>
NV graphics	<b>GS ( L</b> <Function67> <Function68> <Function69>
Downloaded graphics	<b>GS ( L</b> <Function83> <Function84> <Function85>

# CONFIDENTIAL

[Model-dependent variations]

**TM-J2100**, **TM-U230**, **TM-U220**

## Program Example for all printers

```
PRINT #1, CHR$(&H1B);"r";CHR$(1);←Select red
PRINT #1, "AAAAA";CHR$(&HA);
PRINT #1, CHR$(&H1B);"r";CHR$(0); ←Select black
PRINT #1, "BBBBB";CHR$(&HA);
```

## Print Sample

```
AAAAA ←Red
BBBBB ←Black
```

### **TM-J2100**

**GS ( N or GS ( L are recommended when defining two-color printing with this printer.**

**When standard mode is selected, setting of this command affects the printing characters, ESC \*, NV bit images, and downloaded bit images.**

### **TM-U230**

**This command is enabled with the two-color model.**

### **TM-U220**

**This command is enabled with the two-color model.**



## ESC t

[Name] Select character code table

[Format] ASCII ESC t **n**  
 Hex 1B 74 **n**  
 Decimal 27 116 **n**

[Range] **TM-J2000/J2100, TM-T90, TM-T88IV, TM-T70, TM-L90, TM-P60:**  
 $0 \leq n \leq 5, 16 \leq n \leq 19, n = 255$   
**TM-U230:**  $0 \leq n \leq 5, n = 16, 254, 255$  (Other than the following models)  
 $0 \leq n \leq 8, n = 16, 254, 255$  (Japanese model)  
**TM-U220:**  $0 \leq n \leq 5, 16 \leq n \leq 19, n = 254, 255$  (Other than the following models)  
 $0 \leq n \leq 8, 16 \leq n \leq 19, n = 254, 255$  (Japanese model)

[Default] **n = 0**

[Printers not featuring this command] None

[Description] Selects a page **n** from the character code table as follows:

<b>n</b>	<b>Character code table</b>
0	Page 0 [PC437 (U.S.A., Standard Europe)]
1	Page 1 [Katakana]
2	Page 2 [PC850 (Multilingual)]
3	Page 3 [PC860 (Portuguese)]
4	Page 4 [PC863 (Canadian-French)]
5	Page 5 [PC865 (Nordic)]
6	Page 6 [Simplified Kanji, Hirakana]
7	Page 7 [Simplified Kanji]
8	Page 8 [Simplified Kanji]
16	Page 16 [WPC1252]



# C O N F I D E N T I A L

## **TM-J2000/J2100, TM-T90, TM-L90**

Page 255 is able to be edited by <Function 7> ~ <Function 10> of **GS ( E**. When the printer is shipped, the page is a space page.

## **TM-T88IV, TM-T70**

Page 255 is a space page.

## **TM-P60**

Page 255 is able to be edited by <Function 7> ~ <Function 10> of **GS ( E**. When the printer is shipped, the page is a space page.

Settings of this command do not affect special font (24 × 48) printing. Special fonts (24 × 48) print page 0[PC437(USA, Standard Europe)] characters irrespective of the settings of this command.

## **TM-U230, TM-U220**

Page 254 and 255 are space pages.

## ESC {

SETTING COMMAND

[Name] Turn upside-down print mode on/off

[Format] ASCII ESC { **n**  
 Hex 1B 7B **n**  
 Decimal 27 123 **n**

[Range]  $0 \leq n \leq 255$

[Default] **n** = 0

[Printers not featuring this command] None

[Description] In standard mode, turns upside-down print mode on or off.

- When the LSB of **n** is 0, upside-down print mode is turned off.
- When the LSB of **n** is 1, upside-down print mode is turned on.

- [Notes]
- When standard mode is selected, this command is enabled only when processed at the beginning of the line.
  - The upside-down print mode is effective for all data in standard mode except the following:
    - The graphics from **GS ( L** of <Function 112>.
    - Raster bit image from **GS v 0**.
    - Variable vertical size bit image from **GS Q 0**.
  - The upside-down print mode has no effect in page mode. If this command is processed in page mode, an internal flag is activated, and this flag is enabled when the printer returns to standard mode.
  - The settings of this command are effective until **ESC @** is executed, the printer is reset, or the power is turned off.
  - When upside-down print mode is turned on, the printer prints 180°-rotated characters from right to left. The line printing order is not reversed; therefore, be careful of the order of the data transmitted.

# CONFIDENTIAL

[Model-dependent variations] None

## Program Example for all printers

```
PRINT #1, CHR$(&H1B);"{";CHR$(0); ← Cancel
  PRINT #1, "ABCDE"; CHR$(&HA);
  PRINT #1, "BCDEF"; CHR$(&HA);
PRINT #1, CHR$(&H1B);"{";CHR$(1); ← Select
  PRINT #1, "ABCDE"; CHR$(&HA);
  PRINT #1, "BCDEF"; CHR$(&HA);
```

## Print Sample

Normal printing

ABCDE  
BCDEF

BCDEF  
ABCDE

Upside-down  
printing

## GS ( N

[Name] Select character effects

[Printers not featuring this command] **TM-T70**, **TM-P60**, **TM-U230**, **TM-U220**

[Description] Selects the character style(s)

- Function code **fn** specifies the function.

<b>fn</b>	<b>Function No.</b>	<b>Function name</b>
48	<b>Function 48</b>	Select character color
49	<b>Function 49</b>	Select background color
50	<b>Function 50</b>	Turn shading mode on/off

- **pL**, **pH** specifies (**pL** + **pH** × 256) as the number of bytes after **pH** (**fn** and **[parameters]**). Description of the **[parameters]** is described in each function.

- [Notes]
- The function is defined by function code (**fn**). Details of performance differ, depending on the function.
  - Settings of this command affect printing of alphanumeric, Katakana, multilingual, user-defined, and user-defined Kanji characters.
  - Settings of this command are effective until **ESC @** is executed, the printer is reset, or the power is turned off.
  - Settings of this command do not affect printing of graphics, bit image, bar code (including HRI characters), and two dimension code.
  - The color of the graphics can be specified by **GS ( L**.

[Model-dependent variations] **TM-J2000/J2100**, **TM-T90**, **TM-T88IV**, **TM-L90**

**Program Example for all printers**

```

PRINT #1, CHR$( &H1D ); " (N"; CHR$( 2 ); CHR$( 0 );
PRINT #1, CHR$( 48 ); CHR$( 49 ); ←Set character color 1
PRINT #1, "Color 1";
PRINT #1, CHR$( &H1D ); " (N"; CHR$( 2 ); CHR$( 0 );
PRINT #1, CHR$( 48 ); CHR$( 50 ); ←Set character color 2
PRINT #1, "Color 2";
    
```

**Print Sample**

Color 1 *Color 2*

## TM-J2000/J2100

The printer supports all functions.

When using ink cartridge SJIC5 only for **TM-J2000**, only Color 1 is available.

When using ink cartridges SJIC2 and SJIC4 only for **TM-J2100**, the following character colors are available.

Color selection	Character color
Color 1	Black (SJIC3 (K))
Color 2	Red (SJIC4 (R)), Blue (SJIC4 (B)), Green (SJIC4 (G))
Color 3	Color 1 + Color 2

## TM-T90, TM-T88IV, TM-L90

This printer supports only Function 48.

This function applies to printing characters on the two-color thermal paper.

Color selection	Character color	Controls
Color 1	Black (KR, KB, KG)	Print by high energy
Color 2	Red (KR)	Print by low energy

Characters printed with Color 2 may fade, depending on the storage environment. Therefore, when the printing needs to last a long time, print with Color 1.

## GS ( N pL pH fn m <Function 48>

---

[Name]	Select character color
[Format]	ASCII    GS (    N <b>pL</b> <b>pH</b> <b>fn</b> <b>m</b> Hex        1D 28 4E <b>02</b> <b>00</b> <b>30</b> <b>m</b> Decimal    29 40 78 <b>2</b> <b>0</b> <b>48</b> <b>m</b>
[Range]	$(pL + pH \times 256) = 2$ ( $pL = 2, pH = 0$ ) <b>TM-J2000 (single-color printing model): m = 48, 49</b> <b>TM-J2100 (two-color printing model): 48 ≤ m ≤ 51</b> <b>TM-T90, TM-T88IV, TM-L90: m = 49, 50</b>
[Default]	<b>m = 49</b>
[Description]	Selects character color specified by <b>m</b> as follows:

<b>m</b>	<b>Character color</b>
48	None (not print)
49	Color 1
50	Color 2
51	Color 3

- [Notes]
- When None (**m = 48**) is selected, the printer treats the character as nonprinting dots. When using this parameter combined with Function 50, characters can be printed in white with shadow on a black background.
  - When underline mode is turned on, the underline will be printed in the color specified by this function.
  - In white/black reverse print mode, the printer treats the character as nonprinting dots and prints the background in the color specified by this function.
  - When character with shadow is selected by Function 50, dots, except for the background and shadow parts, are printed in the color specified by this function.

[Model-dependent variations]            **TM-J2000/J2100, TM-T90, TM-L90, TM-T88IV**



# CONFIDENTIAL

## **TM-J2000/J2100**

After processing this function, the bit images (ESC \*), downloaded bit images, and NV bit images are always printed in Color 1.

## **TM-T90, TM-L90**

This function is available only when the recommended two-color thermal paper is selected.

## **TM-T88IV**

This function can be used when two-color printing control is selected with **GS ( E <Function 5>**.

# CONFIDENTIAL

## GS ( N pL pH fn m <Function 49>

---

[Name] Select background color

[Format] ASCII GS ( N pL pH fn m  
Hex 1D 28 4E 02 00 31 m  
Decimal 29 40 78 2 0 49 m

[Range]  $(pL + pH \times 256) = 2$  ( $pL = 2, pH = 0$ )  
**TM-J2000 (single-color printing model): m = 48, 49**  
**TM-J2100 (two-color printing model):  $48 \leq m \leq 51$**

[Default] m = 48

[Description] Selects background color by m as follows:

m	Background color
48	None (not print)
49	Color 1
50	Color 2
51	Color 3

- [Notes]
- This function does not affect the color of the spaces skipped by **HT**, **ESC \$**, and **ESC \**; the spaces between rows; and background of the characters in white/black reverse print mode.
  - The color of the spaces between characters set by **ESC SP**, **FS S** will be printed in the color specified by this function.
  - When a character with shadow is selected by Function 50, dots, except for the background and shadow parts, are printed in the color specified by this function.

[Model-dependent variations] **TM-J2000/J2100, TM-T90, TM-T88IV, TM-L90**

### TM-J2000/J2100

**After processing this function, the bit images (ESC \*), downloaded bit images, and NV bit images are always printed in Color 1.**

# CONFIDENTIAL

**TM-T90, TM-T88IV, TM-L90**

**This printer does not support this function.**

## GS ( N pL pH fn m <Function 50>

[Name] Turn shading mode on/off

[Format] ASCII GS ( N **pL pH fn m a**  
 Hex 1D 28 4E **03 00 32 m a**  
 Decimal 29 40 78 **3 0 50 m a**

[Range] (**pL + pH** × 256) = 3 (**pL** =3, **pH** =0)  
**fn** = 50  
**m** = 0, 1, 48, 49  
**TM-J2000/J2100: a = 48**

[Default] **m** = 0, **a** = 48

[Default] Turns the character shadow mode on or off.

<b>m</b>	<b>Function</b>
0, 48	Character shadow mode is turned on.
1, 49	Character shadow mode is turned off.

Prints the character shadow in the color specified by **a** as follows:

<b>a</b>	<b>Shadow color</b>
48	None (not print)
49	Color 1
50	Color 2
51	Color 3

[Notes] ■ Even if underline mode is turned on, the shadow of the underline is not printed.  
 ■ In white/black reverse print mode, the color of the shadow specified by this function does not change.

[Model-dependent variations] **TM-J2000/J2100, TM-T90, TM-T88IV, TM-L90**

# CONFIDENTIAL

## **TM-J2000/J2100**

The color of the shadow cannot be specified. Always select None (a = 48).

## **TM-T90, TM-T88IV, TM-L90**

This printer does not support this function.

## GS !

[Name] Select character size

[Format] ASCII GS ! **n**  
 Hex 1D 21 **n**  
 Decimal 29 33 **n**

[Range]  $0 \leq n \leq 7$ ,  $16 \leq n \leq 23$ ,  $32 \leq n \leq 39$ ,  $48 \leq n \leq 55$ ,  
 $64 \leq n \leq 71$ ,  $80 \leq n \leq 87$ ,  $96 \leq n \leq 103$ ,  $112 \leq n \leq 119$   
 (1 ≤ height ≤ 8, 1 ≤ width ≤ 8)

[Default] **n** = 0

[Printers not featuring this command] **TM-U230**, **TM-U220**

[Description] Selects the character height (vertical number of times normal font size) using bits 0 to 2 and selects the character width (horizontal number of times normal font size) using bits 4 to 6, as follows:

Character width selection					
Bit 6	Bit 5	Bit 4	Hex	Decimal	Width
Off	Off	Off	00	0	1 (normal)
Off	Off	On	10	16	2 (double-width)
Off	On	Off	20	32	3
Off	On	On	30	48	4
On	Off	Off	40	64	5
On	Off	On	50	80	6
On	On	Off	60	96	7
On	On	On	70	112	8

Character height selection					
Bit 2	Bit 1	Bit 0	Hex	Decimal	Height
Off	Off	Off	00	0	1 (normal)
Off	Off	On	01	1	2 (double-height)
Off	On	Off	02	2	3
Off	On	On	03	3	4
On	Off	Off	04	4	5
On	Off	On	05	5	6
On	On	Off	06	6	7
On	On	On	07	7	8

# CONFIDENTIAL

- [Notes]
- The character size set by this command is effective for alphanumeric, Kana, multilingual, and user-defined characters.
  - When the characters are enlarged with different heights on one line, all the characters on the line are aligned at the baseline.
  - When the characters are enlarged widthwise, the characters are enlarged to the right, based on the left side of the character.
  - **ESC !** can also turn double-width and double-height modes on or off.
  - In standard mode, the character is enlarged in the paper feed direction when double-height mode is selected, and it is enlarged perpendicular to the paper feed direction when double-width mode is selected. However, when character orientation changes in 90° clockwise rotation mode, the relationship between double-height and double-width is reversed.
  - In page mode, double-height and double-width are on the character orientation.
  - The setting of the character size of alphanumeric and Katakana is effective until **ESC !** is executed, **ESC @** is executed, the printer is reset, or the power is turned off.
  - The setting of the character size of Kanji and multilingual characters is effective until **FS !** is executed, **FS W** is executed, **ESC @** is executed, the printer is reset, or the power is turned off.

[Model-dependent variations]

## TM-P60

### Program Example for all printers

```
PRINT #1, CHR$( &H1D ); "!" ; CHR$( 17 );  
PRINT #1, "AAAAA" ; CHR$( &HA );  
PRINT #1, CHR$( &H1D ); "!" ; CHR$( 0 );  
PRINT #1, "BBBBB" ; CHR$( &HA );
```

### Print Sample

AAAAA ← Select quadruple (double-height x double-width)  
BBBBB

## TM-P60

### [Peeler model]

**With special fonts (24 × 48), enlargement of [width: times 1 to times 4/height: times 1 to times 4] is possible. Even when 5 times or more is specified for special fonts (24 × 48), they are printed at 4 times enlargement.**

## GS B

[Name]	Turn white/black reverse print mode on/off												
[Format]	<table border="0"> <tr> <td>ASCII</td> <td>GS</td> <td>B</td> <td><b>n</b></td> </tr> <tr> <td>Hex</td> <td>1D</td> <td>42</td> <td><b>n</b></td> </tr> <tr> <td>Decimal</td> <td>29</td> <td>66</td> <td><b>n</b></td> </tr> </table>	ASCII	GS	B	<b>n</b>	Hex	1D	42	<b>n</b>	Decimal	29	66	<b>n</b>
ASCII	GS	B	<b>n</b>										
Hex	1D	42	<b>n</b>										
Decimal	29	66	<b>n</b>										
[Range]	$0 \leq n \leq 255$												
[Default]	<b>n</b> = 0												
[Printers not featuring this command]	<b>TM-U230</b> , <b>TM-U220</b>												
[Description]	<p>Turns white/black reverse print mode on or off.</p> <ul style="list-style-type: none"> <li>• When the LSB of <b>n</b> is 0, white/black reverse print mode is turned off.</li> <li>• When the LSB of <b>n</b> is 1, white/black reverse print mode is turned on.</li> </ul>												
[Notes]	<ul style="list-style-type: none"> <li>■ The white/black reverse print mode is effective for alphanumeric, Kana, multilingual, and user-defined characters.</li> <li>■ When white/black reverse print mode is turned on, it also affects the right-side character spacing set by <b>ESC SP</b>.</li> <li>■ When white/black reverse print mode is turned on, it does not affect the space between lines.</li> <li>■ When underline mode is turned on, the printer does not underline white/black reverse characters.</li> <li>■ This command is effective until <b>ESC @</b> is executed, the printer is reset, or the power is turned off.</li> <li>■ In white/black reverse print mode, characters are printed in white on a black background.</li> </ul>												



# CONFIDENTIAL

[Model-dependent variations]

None

## Program Example for all printers

```
PRINT #1, CHR$(&H1D);"B";CHR$(1); ←Select  
PRINT #1, "AAAAA"; CHR$(&HA);  
PRINT #1, CHR$(&H1D);"B";CHR$(0); ←Cancel  
PRINT #1, "BBBBB"; CHR$(&HA);
```

## Print Sample

```
AAAAA ←White/black reverse printing  
BBBBB ←Normal printing
```

## GS b

[Name] Turn smoothing mode on/off

[Format] ASCII GS b **n**  
 Hex 1D 62 **n**  
 Decima 29 98 **n**

[Range]  $0 \leq n \leq 255$

[Default] **n** = 0

[Printers not featuring this command] **TM-U230, TM-U220**

[Description] Turns smoothing mode on or off.

- When the LSB of **n** is 0, smoothing mode is turned off.
- When the LSB of **n** is 1, smoothing mode is turned on.

[Notes] ■ The smoothing mode is effective for quadruple-size or larger characters [alphanumeric, Kana, multilingual, and user-defined characters.]

■ This command is effective until **ESC @** is executed, the printer is reset, or the power is turned off.

[Model-dependent variations] None

### Program Example for all printers

```
PRINT #1, CHR$( &H1D ); "!" ; CHR$( 68 ); ←Select font size
PRINT #1, CHR$( &H1D ); "b" ; CHR$( 1 ); ←Select smoothing
PRINT #1, "AAAAA" ; CHR$( &HA );
```

### Print Sample

AAAAA

## PANEL BUTTON COMMANDS

Command	Name
---------	------

<b>ESC c 5</b>	Enable/disable panel buttons
----------------	------------------------------

## ESC c 5

[Name]	Enable/disable panel buttons															
[Format]	<table border="0"> <tr> <td>ASCII</td> <td>ESC</td> <td>c</td> <td>5</td> <td><b>n</b></td> </tr> <tr> <td>Hex</td> <td>1B</td> <td>63</td> <td>35</td> <td><b>n</b></td> </tr> <tr> <td>Decimal</td> <td>27</td> <td>99</td> <td>53</td> <td><b>n</b></td> </tr> </table>	ASCII	ESC	c	5	<b>n</b>	Hex	1B	63	35	<b>n</b>	Decimal	27	99	53	<b>n</b>
ASCII	ESC	c	5	<b>n</b>												
Hex	1B	63	35	<b>n</b>												
Decimal	27	99	53	<b>n</b>												
[Range]	$0 \leq n \leq 255$															
[Default]	<b>n</b> = 0															
[Printers not featuring this command]	None															
[Description]	<p>Enables or disables the panel buttons.</p> <ul style="list-style-type: none"> <li>• When the LSB of <b>n</b> is 0, all buttons are enabled.</li> <li>• When the LSB of <b>n</b> is 1, all buttons are disabled.</li> </ul>															
[Notes]	<ul style="list-style-type: none"> <li>■ If panel buttons are disabled, the function of the panel button, such as feeding, will be executed when the panel button is turned on.</li> <li>■ When the printer cover is open, there are buttons that are always enabled or disabled regardless of this command. The buttons are different, depending on the printer model.</li> <li>■ Even if the panel buttons are disabled by this command, paper feed button will be enabled temporarily while printer is waiting for the buttons to be pressed in the following states. Whether the paper can be fed or not depends on the state:             <ul style="list-style-type: none"> <li>• When a new roll paper is installed in the <b>TM-U230</b> (see <b>GS z 0</b> to determine if paper can be fed or not)</li> <li>• When waiting for an online recovery for the <b>TM-L90</b> with Peeler (see <b>GS z 0</b> (Peeler specification) for details)</li> <li>• When the printer is waiting for the button to be pressed while <b>GS ^</b> is executed (but paper cannot be fed)</li> </ul> </li> <li>■ To prevent problems caused by accidentally pressing the buttons, use this command to disable the buttons.</li> </ul>															

# CONFIDENTIAL

[Model-dependent variations]

**TM-J2000/J2100**, **TM-T90**, **TM-T88IV**, **TM-T70**, **TM-L90**, **TM-P60**, **TM-U230**,  
**TM-U220**

## Program Example for all printers

```
PRINT #1, CHR$(&H1B);"c5";CHR$(1); ← Disable panel buttons
```

### **TM-J2000/J2100**

The panel buttons are **PAPER FEED** and **CLEANING**. The setting of this command does not affect the **CLEANING** button.

When executing **GS ^**, if the **PAPER OUT LED** flashes, the **PAPER FEED** button is enabled regardless of the setting of this command. Even if the button is pressed, paper cannot be fed.

When the roll paper end sensor detects a paper end, the **PAPER FEED** button is enabled regardless of the setting of this command. Even if the button is pressed, paper cannot be fed.

When the cover is open or the roll paper end sensor detects a paper end, the **PAPER FEED** button is disabled regardless of the settings of this command.

### **TM-T90, TM-T88IV**

The panel button is **FEED**.

When executing **GS ^**, if the **PAPER OUT LED** flashes, the **PAPER FEED** button is enabled regardless of the setting of this command. However, paper cannot be fed by the button.

When the **PAPER OUT LED** flashes with executing macro function, the **FEED** button is enabled regardless of the setting of this command. Even if the button is pressed, paper cannot be fed.

When the cover is open or the roll paper end sensor detects a paper end, the **FEED** button is disabled regardless of the settings of this command.

### **TM-T70**

The panel button is **FEED**.

When the cover is open or the roll paper end sensor detects a paper end, the **FEED** button is disabled regardless of the settings of this command.

## TM-L90

The panel button is FEED.

When the cover is open or the roll paper end sensor detects a paper end, the FEED button is disabled regardless of the settings of this command.

### TM-L90 with Peeler

When executing **GS ^** or when the peeling issuing mode is selected and the printer is in one of the following status conditions, if the PAPER OUT LED blinks, the FEED button is enabled regardless of the setting of this command. However, paper cannot be fed by the button.

- Waiting for the FEED button to be pressed with the cover closed.
- Waiting for the FEED button to be pressed when removing a label (when the peeling detector cannot detect a label due to sunlight)

### TM-L90 models without Peeler

When executing **GS ^**, if the PAPER OUT LED flashes, the FEED button is enabled regardless of the setting of this command. Even if the button is pressed, paper cannot be fed.

## TM-P60

The panel button is FEED.

When the FEED button is operated to print a status sheet, the FEED button is enabled regardless of the setting of this command. Even if the switch is pressed, paper cannot be fed.

When the cover is open, or the roll paper end sensor detects a paper end, the FEED button is disabled regardless of the settings of this command. ("Cover" in the peeler specification indicates the peeler cover.)

## **TM-U230**

The panel button is PAPER FEED.

When you change the roll paper after the printer stops printing because of roll paper end, the following processing is done regardless of the settings of this command.

- When the printer is waiting for the roll paper to be set (the LED is off), the PAPER FEED is enabled, and paper can be fed.
- When the LED blinks to indicate that the printer is confirming the status, the PAPER FEED is enabled. Even if the switch is pressed, paper cannot be fed.

## **TM-U220**

The panel button is FEED.

When the roll paper end sensor detects a paper end, the FEED button is enabled regardless of the setting of this command.

When the cover is open, the FEED button is disabled regardless of the settings of this command.

## PAPER SENSOR COMMANDS

---

Command	Name
---------	------

<b>ESC c 3</b>	Select paper sensor(s) to output paper-end signals
<b>ESC c 4</b>	Select paper sensor(s) to stop printing



## ESC c 3

[Name] Select paper sensor(s) to output paper-end signals

[Format] ASCII    ESC c    3    **n**  
 Hex        1B 63 33    **n**  
 Decimal    27 99 51    **n**

[Range]  $0 \leq n \leq 255$

[Default] **TM-J2000/J2100, TM-T70, TM-L90: n = 0**  
**TM-T90: n = 0 (For the Japanese model or when memory switch Msw 8-7 is OFF.)**  
**n = 15 (When the memory switch Msw 8-7 is ON.)**  
**TM-T88IV: n = 0 (When the DIP switch SW1-3 is ON.)**  
**n = 15 (When the DIP switch SW1-3 is OFF.)**  
**TM-U230, TM-U220: n = 15**

[Printers not featuring this command] **TM-P60**

[Description] Selects the paper sensor(s) to output paper end signals when a paper end is detected using **n** as follows:

<b>n: Bit</b>	<b>Off/On</b>	<b>Hex</b>	<b>Decimal</b>	<b>Function</b>
0	Off	00	0	Roll paper near-end sensor disabled.
	On	01	1	Roll paper near-end sensor enabled.
1	Off	00	0	Roll paper near-end sensor disabled.
	On	02	2	Roll paper near-end sensor enabled.
2	Off	00	0	Roll paper end sensor disabled.
	On	02	4	Roll paper end sensor enabled.
3	Off	00	0	Roll paper end sensor disabled.
	On	08	8	Roll paper end sensor enabled.
4-7	—	—	—	Undefined.

*... how to use  
this table*

# CONFIDENTIAL

- [Notes]
- This command is enabled only with a parallel interface and is ignored with a serial interface.
  - The roll paper near-end sensor is enabled when either bit 0 or bit 1 is on or both are on.
  - The roll paper end sensor is enabled when either bit 2 or bit 3 is on or both are on.
  - It is possible to select multiple sensors to output signals. When any of the sensors detects a paper-end, the paper-end signal is output.
  - When all sensors are disabled, the paper-end signal is always paper present.
  - Some sensors are not present, depending on the printer model.
  - The names of some sensors differ, depending on the printer model.
  - The settings of this command are effective until **ESC @** is executed, the printer is reset, or the power is turned off.

[Model-dependent variations]

**TM-T90, TM-U220**

## Program Example for all printers

```
PRINT #1, CHR$(&H1B);"c3";CHR$(4); ← Roll paper end sensor enabled
```

### **TM-T90**

The memory switch can be set by Function 3 of **GS ( E**.

### **TM-U220**

The roll paper near-end sensor is an option. If the roll paper near-end sensor is not included, this printer does not detect a roll paper near-end.

## ESC c 4

[Name] Select paper sensor(s) to stop printing

[Format] ASCII ESC c 4 **n**  
 Hex 1B 63 34 **n**  
 Decimal 27 99 52 **n**

[Range]  $0 \leq n \leq 255$

[Default] **n** = 0

[Printers not featuring this command] **TM-P60**

[Description] Selects the paper sensor(s) to use to stop printing when a paper end is detected using **n** as follows:

n: Bit	Off/On	Hex	Decimal	Function
0	Off	00	0	Roll paper near-end sensor disabled.
	On	01	1	Roll paper near-end sensor enabled.
1	Off	00	0	Roll paper near-end sensor disabled.
	On	02	2	Roll paper near-end sensor enabled.
2	Off	00	0	Roll paper end sensor disabled.
	On	02	4	Roll paper end sensor enabled.
3	Off	00	0	Roll paper end sensor disabled.
	On	08	8	Roll paper end sensor enabled.
4-7	—	—	—	Undefined.

... *how to use this table*

- [Notes]
- It is possible to select multiple sensors to stop printing. When any sensor detects a paper-end, printing stops.
  - Some sensors are not present, depending on the printer model.
  - The names of some sensors differ, depending on the printer model.
  - The roll paper near-end sensor is enabled when either bit 0 or bit 1 is on or both are on.

- The roll paper end sensor is enabled when either bit 2 or bit 3 is on or both are on.
- When a paper near-end is detected, printing stops after printing the current line and feeding the paper. The printer goes offline and Paper LED comes on after printing stops. To resume printing, cancel the “roll paper near-end” status by replacing the roll paper.
- If the roll paper near-end sensor is disabled and a paper near-end is detected, printing does not stop and the printer does not go offline, but the Paper LED does come on.
- When a roll paper end is detected, the printer performs the same operations as when a roll paper near-end is detected.
- The settings of this command are effective until **ESC @** is executed, the printer is reset, or the power is turned off.

[Model-dependent variations]

**TM-J2000/J2100, TM-T90, TM-T88IV, TM-T70, TM-L90, TM-U230, TM-U220**

### Program Example for all printers

```
PRINT #1, CHR$(&H1B);"c4";CHR$(1); ←Roll paper near-end sensor enabled
```

**TM-J2000/J2100, TM-T90, TM-T88IV, TM-T70, TM-L90**

**Bits 2 and 3 are undefined.**

**The roll paper end sensor is always enabled, and when it detects a paper-end, the printer stops printing.**

**When a roll paper near-end or a roll paper end are detected, the PAPER OUT LED comes on.**

## **TM-U230**

**Bits 2 and 3 are undefined.**

**The roll paper end sensor is always enabled, and when it detects a paper-end, the printer stops printing.**

**When a roll paper near-end or a roll paper end is detected, the PAPER OUT LED comes on.**

**When the built-in buzzer is enabled (DIP switch 2-8 is ON), the buzzer rings when the PAPER OUT LED comes on.**

## **TM-U220**

**Bits 2 and 3 are undefined.**

**The roll paper end sensor is always enabled, and when it detects a paper-end, the printer stops printing.**

**When a roll paper near-end or a roll paper end is detected, the PAPER OUT LED comes on.**

**The roll paper near-end sensor is an option. When the roll paper near-end sensor is not included, this command is ignored.**

## PRINT POSITION COMMANDS

Command	Name
---------	------

<b>HT</b>	Horizontal tab
<b>ESC \$</b>	Set absolute print position
<b>ESC D</b>	Set horizontal tab positions
<b>ESC T</b>	Select print direction in page mode
<b>ESC W</b>	Set print area in page mode
<b>ESC \</b>	Set relative print position
<b>ESC a</b>	Select justification
<b>GS \$</b>	Set absolute vertical print position in page mode
<b>GS L</b>	Set left margin
<b>GS T</b>	Set print position to the beginning of print line
<b>GS W</b>	Set print area width
<b>GS \</b>	Set relative vertical print position in page mode

## HT

[Name] Horizontal tab

[Format] ASCII HT  
Hex 09  
Decimal 9

[Range] None

[Default] None

[Printers not featuring this command] None

[Description] Moves the print position to the next horizontal tab position.

- [Notes]
- This command is ignored unless the next horizontal tab position has been set.
  - Horizontal tab positions are set by **ESC D**.
  - If the next horizontal tab position exceeds the print area, the printer sets the print position to [Print area width + 1].
  - If this command is processed when the print position is at [Print area width + 1], the printer executes print buffer-full printing of the current line and horizontal tab processing from the beginning of the next line. In this case, in page mode, the printer does not execute printing, but the print position is moved.
  - When underline mode is turned on, the underline will not be printed under the tab space skipped by this command.

[Model-dependent variations] None

**See program example and print sample for HT and ESC D.**

## ESC \$

[Name] Set absolute print position

[Format] ASCII      ESC \$    **nL**   **nH**  
 Hex        1B 24   **nL**   **nH**  
 Decimal    27 36   **nL**   **nH**

[Range]       $0 \leq \mathbf{nL} \leq 255$   
                $0 \leq \mathbf{nH} \leq 255$

[Printers not featuring this command] **TM-U230**, **TM-U220**

[Description] Moves the print position to  $(\mathbf{nL} + \mathbf{nH} \times 256) \times$  (horizontal or vertical motion unit) from the left edge of the print area.

- [Notes]
- The printer ignores any setting that exceeds the print area.
  - When standard mode is selected, the horizontal motion unit is used.
  - When page mode is selected, the horizontal or vertical motion unit is used for the print direction set by **ESC T**.
    - When the starting position is set to the upper left or lower right of the print area using **ESC T**, the horizontal motion unit is used.
    - When the starting position is set to the upper right or lower left of the print area using **ESC T**, the vertical motion unit is used.
  - If the horizontal or vertical motion unit is changed after this command is executed, the print position is not changed.
  - Even if underline mode is turned on, the underline will not be printed under the space skipped by this command.

[Model-dependent variations]      **TM-J2000/J2100**, **TM-T90**, **TM-T88IV**, **TM-T70**, **TM-L90**, **TM-P60**

See program example and print sample for ESC \$ and ESC \.

**TM-J2000/J2100**, **TM-T90**, **TM-T88IV**, **TM-T70**, **TM-L90**

The vertical or horizontal motion unit is specified by **GS P**.



# CONFIDENTIAL

## TM-P60

The vertical or horizontal motion unit is approximately 0.125 mm {1/203 inches}. This value equals one dot pitch.

## ESC D

SETTING COMMAND

[Name]	Set horizontal tab positions				
[Format]	ASCII	ESC D	<b>n1 ... nk</b>	<b>NUL</b>	
	Hex	1B 44	<b>n1 ... nk</b>	<b>00</b>	
	Decimal	27 68	<b>n1 ... nk</b>	<b>0</b>	
[Range]	$1 \leq n \leq 255$ $0 \leq k \leq 32$				
[Default]	<b>n</b> = 8, 16, 24, 32, ... (Every eight characters for the default font set by <b>ESC !</b> or <b>ESC M</b> )				
[Printers not featuring this command]	None				
[Description]	Sets horizontal tab positions. <ul style="list-style-type: none"> <li>• <b>n</b> specifies the number of digits from the setting position to the left edge of the print area.</li> <li>• <b>k</b> indicates the number of horizontal tab positions to be set.</li> </ul>				
[Notes]	<ul style="list-style-type: none"> <li>■ The horizontal tab position is stored as a value of [character width × <b>n</b>] measured from the beginning of the line. The character width includes the right-side character spacing, and double-width characters are selected with twice the width of normal characters.</li> <li>■ The character width should be set before using this command. Settings of character fonts, space width, and enlargement affect the setting of character width.</li> <li>■ A maximum of 32 horizontal tab positions can be set. Data exceeding 32 horizontal tab positions is processed as normal data.</li> <li>■ This command cancels any previous horizontal tab settings.</li> <li>■ Transmit [<b>n</b>]<b>k</b> in ascending order and place a <b>NUL</b> code at the end. <b>ESC D NUL</b> cancels all horizontal tab positions.</li> <li>■ When [<b>n</b>] is less than or equal to the preceding value [<b>n</b>]<b>k</b>-1, horizontal tab setting is finished, and the following data is processed as normal data.</li> <li>■ <b>k</b> is not transmission data to the printer.</li> <li>■ Even if the character width is changed after setting the horizontal tab positions, the setting of the horizontal tab positions will not be changed.</li> </ul>				

# CONFIDENTIAL

- Horizontal tab position settings are effective until **ESC @** is executed, the printer is reset, or the power is turned off.
- Print position can be changed by **HT**.
- When the left margin setting is changed, the horizontal tab position is also changed.

[Model-dependent variations]          None

## Program example for HT and ESC D

### Program Example

```
PRINT #1, "0123456789012345678901234567890123456";
PRINT #1, CHR$(&HA);
FOR i=1 TO 4
  PRINT #1, CHR$(&H9); "H"; ← Execute HT
NEXT i : PRINT #1, CHR$(&HA);
PRINT #1, CHR$(&H1B); "D";CHR$(10);CHR$(20);
PRINT #1, CHR$(30);CHR$(0); ← Set HT positions
FOR i=1 TO 4
  PRINT #1, CHR$(&H9); "H"; ← Execute HT
NEXT i : PRINT #1, CHR$(&HA);
```

### Print Sample

```
0123456789012345678901234567890123456
      H      H      H      H
      ↑      ↑      ↑      ↑
      H      H      HH     H
      ↑      ↑      ↑      ↑
      Tab   Tab   Tab
      position position position
      10    20    30
Default → 8      16      24      32
```

## ESC T

[Name] Select print direction in page mode

[Format] ASCII ESC T **n**  
 Hex 1B 54 **n**  
 Decimal 27 84 **n**

[Range]  $0 \leq n \leq 3, 48 \leq n \leq 51$

[Default] **n** = 0

[Printers not featuring this command] **TM-U230, TM-U220**

[Description] In page mode, selects the print direction and starting position using **n** as follows:

<b>n</b>	<b>Print direction</b>	<b>Starting position</b>
0, 48	Left to right	Upper left (A in the figure)
1, 49	Bottom to top	Lower left (B in the figure)
2, 50	Right to left	Lower right (C in the figure)
3, 51	Top to bottom	Upper right (D in the figure)

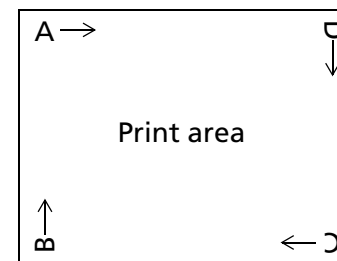

- [Notes]
- The print direction set by this command is effective only in page mode.
  - This command setting has no effect in standard mode. If this command is processed in standard mode, an internal flag is activated, and this flag is enabled when the printer selects page mode.
  - The parameters for the horizontal or vertical motion unit differ, depending on the starting position of the print area as follows:
    - If the starting position is the upper left or lower right of the print area:  
 These commands use horizontal motion units: **ESC SP, ESC \$, ESC \**  
 These commands use vertical motion units: **ESC 3, ESC J, GS \$, GS \**

# CONFIDENTIAL

- If the starting position is the upper right or lower left of the print area:  
These commands use horizontal motion units: **ESC 3**, **ESC J**, **GS \$**, **GS \**  
These commands use vertical motion units: **ESC SP**, **ESC \$**, **ESC \**
- The settings of this command are effective until **ESC @** is executed, the printer is reset, or the power is turned off.

[Model-dependent variations]

None

## Program Example for all printers

```
PRINT #1, CHR$(&H1B);"L"; ←Select page mode
PRINT #1, CHR$(&H1D);"P";CHR$(180);CHR$(180);
PRINT #1, CHR$(&H1B);"W";CHR$(0);CHR$(0);CHR$(0);CHR$(0);
CHR$(240);CHR$(0);CHR$(200);CHR$(0); ←Set print area
PRINT #1, CHR$(&H1B);"T";CHR$(0); ←Select print direction
PRINT #1, "AAAAA"; CHR$(&HA);
PRINT #1, "BBBBB"; CHR$(&HA);
PRINT #1, CHR$(&H1B);"T";CHR$(1); ←Select print direction
PRINT #1, "CCCCC"; CHR$(&HA);
PRINT #1, "DDDDD"; CHR$(&HA);
PRINT #1, CHR$(&H1B);"T";CHR$(2); ←Select print direction
PRINT #1, "EEEE"; CHR$(&HC); ←Batch print and return to standard mode
```

## Print Sample

```
AAAAA
BBBBB
CCCCC
DDDDD
EEEE
```

← Print area  
set by  
**ESC W**

## ESC W

[Name]	Set print area in page mode									
[Format]	ASCII	ESC W	<b>xL</b>	<b>xH</b>	<b>yL</b>	<b>yH</b>	<b>dxL</b>	<b>dxH</b>	<b>dyL</b>	<b>dyH</b>
	Hex	1B 57	<b>xL</b>	<b>xH</b>	<b>yL</b>	<b>yH</b>	<b>dxL</b>	<b>dxH</b>	<b>dyL</b>	<b>dyH</b>
	Decimal	27 87	<b>xL</b>	<b>xH</b>	<b>yL</b>	<b>yH</b>	<b>dxL</b>	<b>dxH</b>	<b>dyL</b>	<b>dyH</b>
[Range]	$0 \leq \mathbf{xL}, \mathbf{xH}, \mathbf{yL}, \mathbf{yH}, \mathbf{dxL}, \mathbf{dxH}, \mathbf{dyL}, \mathbf{dyH} \leq 255$ (except for $\mathbf{dxL} = \mathbf{dxH} = 0$ or $\mathbf{dyL} = \mathbf{dyH} = 0$ )									
[Default]	Horizontal logical origin and vertical logical origin= 0 $\mathbf{xL} = 0, \mathbf{xH} = 0, \mathbf{yL} = 0, \mathbf{yH} = 0$ Print area width and print area height = entire printable area <b>TM-J2000 (single-color printing model):</b> $(\mathbf{dxL} + \mathbf{dxH} \times 256) = 512 (\mathbf{dxL} = 0, \mathbf{dxH} = 2)$ (when paper width is set to 82.5 mm) $(\mathbf{dyL} + \mathbf{dyH} \times 256) = 1664 (\mathbf{dyL} = 128, \mathbf{dyH} = 6)$ $(\mathbf{dxL} + \mathbf{dxH} \times 256) = 480 (\mathbf{dxL} = 224, \mathbf{dxH} = 1)$ (when paper width is set to 76 mm) $(\mathbf{dyL} + \mathbf{dyH} \times 256) = 1776 (\mathbf{dyL} = 240, \mathbf{dyH} = 6)$ $(\mathbf{dxL} + \mathbf{dxH} \times 256) = 432 (\mathbf{dxL} = 176, \mathbf{dxH} = 1)$ (when paper width is set to 69.5 mm) $(\mathbf{dyL} + \mathbf{dyH} \times 256) = 1968 (\mathbf{dyL} = 176, \mathbf{dyH} = 7)$ $(\mathbf{dxL} + \mathbf{dxH} \times 256) = 360 (\mathbf{dxL} = 104, \mathbf{dxH} = 1)$ (when paper width is set to 57.5 mm) $(\mathbf{dyL} + \mathbf{dyH} \times 256) = 2368 (\mathbf{dyL} = 64, \mathbf{dyH} = 9)$ <b>TM-J2100 (two-color printing model):</b> $(\mathbf{dxL} + \mathbf{dxH} \times 256) = 512 (\mathbf{dxL} = 0, \mathbf{dxH} = 2)$ (when paper width is set to 82.5 mm) $(\mathbf{dyL} + \mathbf{dyH} \times 256) = 1280 (\mathbf{dyL} = 0, \mathbf{dyH} = 5)$ $(\mathbf{dxL} + \mathbf{dxH} \times 256) = 480 (\mathbf{dxL} = 224, \mathbf{dxH} = 1)$ (when paper width is set to 76 mm) $(\mathbf{dyL} + \mathbf{dyH} \times 256) = 1360 (\mathbf{dyL} = 80, \mathbf{dyH} = 5)$ $(\mathbf{dxL} + \mathbf{dxH} \times 256) = 432 (\mathbf{dxL} = 176, \mathbf{dxH} = 1)$ (when paper width is set to 69.5 mm) $(\mathbf{dyL} + \mathbf{dyH} \times 256) = 1520 (\mathbf{dyL} = 240, \mathbf{dyH} = 5)$ $(\mathbf{dxL} + \mathbf{dxH} \times 256) = 360 (\mathbf{dxL} = 104, \mathbf{dxH} = 1)$ (when paper width is set to 57.5 mm) $(\mathbf{dyL} + \mathbf{dyH} \times 256) = 1824 (\mathbf{dyL} = 32, \mathbf{dyH} = 7)$ <b>TM-T90:</b> [Other than Japanese model] $(\mathbf{dxL} + \mathbf{dxH} \times 256) = 512 (\mathbf{dxL} = 0, \mathbf{dxH} = 2)$ (when paper width is set to 80 mm) $(\mathbf{dxL} + \mathbf{dxH} \times 256) = 384 (\mathbf{dxL} = 128, \mathbf{dxH} = 1)$ (when paper width is set to 60 mm)									

$(dxL + dxH \times 256) = 360$  ( $dxL = 104, dxH = 1$ ) (when paper width is set to 58 mm)  
 $(dyL + dyH \times 256) = 1662$  ( $dyL = 126, dyH = 6$ )

[Japanese model]

$(dxL + dxH \times 256) = 576$  ( $dxL = 64, dxH = 2$ ) (when paper width is set to 80 mm)  
 $(dxL + dxH \times 256) = 436$  ( $dxL = 180, dxH = 1$ ) (when paper width is set to 60 mm)  
 $(dxL + dxH \times 256) = 420$  ( $dxL = 164, dxH = 1$ ) (when paper width is set to 58 mm)  
 $(dyL + dyH \times 256) = 1476$  ( $dyL = 196, dyH = 5$ )

**TM-T88IV:**  $(dxL + dxH \times 256) = 512$  ( $dxL = 0, dxH = 2$ ) (when paper width is set to 80 mm)  
 $(dyL + dyH \times 256) = 1662$  ( $dyL = 126, dyH = 6$ )  
 $(dxL + dxH \times 256) = 360$  ( $dxL = 104, dxH = 1$ ) (when paper width is set to 58 mm)  
 $(dyL + dyH \times 256) = 1662$  ( $dyL = 126, dyH = 6$ )

**TM-T70:**  $(dxL + dxH \times 256) = 512$  ( $dxL = 0, dxH = 2$ ) (Other than Japanese model)  
 $(dyL + dyH \times 256) = 1662$  ( $dyL = 126, dyH = 6$ )  
 $(dxL + dxH \times 256) = 416$  ( $dxL = 160, dxH = 1$ ) (Japanese model)

**TM-L90:** [when the origin of layout is selected to "paper layout is not used" or "top of black mark"]  
 $(dxL + dxH \times 256) = 576$  ( $dxL = 64, dxH = 2$ )  
 (when paper width is set to 80 mm to 78 mm)  
 $(dxL + dxH \times 256) = (256 + (\text{paper width} - 38) \times 8)$   
 (when paper width is set to 77 mm to 38 mm)  
 $(dyL + dyH \times 256) = 1476$  ( $dyL = 196, dyH = 5$ )  
 [when the origin of layout is selected to "bottom of label"]  
 $(dxL + dxH \times 256) = 560$  ( $dxL = 48, dxH = 2$ ) (when paper width is set to 80 mm)  
 $(dxL + dxH \times 256) = (224 + (\text{paper width} - 38) \times 8)$   
 (when paper width is set to 79 mm to 38 mm)  
 $(dyL + dyH \times 256) = 1476$  ( $dyL = 196, dyH = 5$ )

**TM-P60:** [Peeler model]  
 $(dxL + dyH \times 256) = 388$  ( $dxL = 132, dxH = 1$ )  
 $(dxL + dyH \times 256) = 1200$  ( $dyL = 176, dyH = 4$ )  
 [Other than peeler model]  
 $(dxL + dxH \times 256) = 420$  ( $dxL = 164, dxH = 1$ ) (when paper width is set to 58 mm)  
 $(dyL + dyH \times 256) = 1200$  ( $dyL = 176, dyH = 4$ )  
 $(dxL + dxH \times 256) = 432$  ( $dxL = 176, dxH = 1$ ) (when paper width is set to 60 mm)  
 $(dyL + dyH \times 256) = 1200$  ( $dyL = 176, dyH = 4$ )

[Printers not featuring this command] **TM-U230**, **TM-U220**

[Description]

In page mode, sets the size and the logical origin of the print area as follows:

- Horizontal logical origin =  $(\mathbf{xL} + \mathbf{xH} \times 256) \times$  (horizontal motion unit) from absolute origin.
- Vertical logical origin =  $(\mathbf{yL} + \mathbf{yH} \times 256) \times$  (vertical motion unit) from absolute origin.
- Print area width =  $(\mathbf{dxL} + \mathbf{dxH} \times 256) \times$  (horizontal motion unit)
- Print area height =  $(\mathbf{dyL} + \mathbf{dyH} \times 256) \times$  (vertical motion unit)

[Notes]

- This command can be used when the page mode is selected by **ESC L**.
- With this command, the printing position is moved to a starting point selected by **ESC T** in the print area set.
- For this command, the horizontal direction means the direction perpendicular to paper feeding direction and the vertical direction means the paper feeding direction.
- Both print area width and height cannot be set to 0.
- The absolute origin is the upper left of the printable area.
- Horizontal logical origin and print area width are calculated using the vertical motion unit.
- Vertical logical origin and print area height are calculated using the horizontal motion unit.
- The horizontal logical origin and the vertical logical origin cannot be set outside the printable area.
- If the horizontal or vertical logical origin is set outside the printable area, this command is canceled, and the following data is processed as normal data.
- If [horizontal logical origin + print area width] exceeds the printable area, the print area width is automatically set to [horizontal printable area – horizontal logical origin].
- If [vertical logical origin + print area height] exceeds the printable area, the print area height is automatically set to [vertical printable area – vertical logical origin].
- Keep the following conditions in mind for printers that support <Function 48> of **GS ( P**.
  - The maximum area that can be specified by this command is the same as the printable area specified by <Function 48> of **GS ( P**.
  - The origin of this command is the same as the upper left point of the printable area specified by <Function 48> of **GS ( P**.



- When adjusting the printable area of the page mode with <Function 48> of **GS ( P**, specify the printable area to be the same as the setting of the printable area by this command after executing **ESC L**.
  - The print area and the logical origin set by this command are effective only in page mode.
  - This command setting has no effect in standard mode. If this command is processed in standard mode, the logical origin and the print area are set, and they are enabled when the printer selects page mode.
  - Even if the horizontal or vertical motion unit is changed after changing the printable area, the setting of the printable area will not be changed.
  - The settings of this command are effective until **FF** is executed, **ESC @** is executed, the printer is reset, or the power is turned off.

[Model-dependent variations]

**TM-J2000/J2100, TM-T90, TM-T88IV, TM-T70, TM-L90, TM-P60**

## Program Example for all printers

```

PRINT #1, CHR$(&H1B);"L";←Select page mode
PRINT #1, CHR$(&H1D);"P";CHR$(180);CHR$(180);
PRINT #1, CHR$(&H1B);"W";CHR$(0);CHR$(0);CHR$(0);CHR$(0);CHR$(180);
CHR$(0);CHR$(44);CHR$(1); ←Set print area
PRINT #1, CHR$(&H1B);"T";CHR$(0); ←Select print direction
PRINT #1, "AAAAA"; CHR$(&HA);
PRINT #1, "BBBBB"; CHR$(&HA);
PRINT #1, CHR$(&H1B);"T";CHR$(2); ←Select print direction
PRINT #1, "CCCCC"; CHR$(&HA);
PRINT #1, "DDDDD"; CHR$(&HC); ←Batch print and return to standard mode
    
```

## Print Sample

← Print area set by **ESC W**

## **TM-J2000/J2100, TM-T90**

**The vertical or horizontal motion unit is specified by **GS P**.**

**See Function 5 of **GS ( E** for specifying the paper width.**

## TM-T88IV

The vertical or horizontal motion unit is specified by **GS P**.

The maximum vertical motion unit that can be set differs according to the printing control (single color/two-color) setting. Refer to **GS ( E <Function 5>** for specifying printing control (single-color/two-color).

- When single-color printing control is selected : 234.35 mm {3324/360 inches}
- When two-color printing control is selected : 117.26 mm {1662/360 inches}

## TM-T70

The vertical or horizontal motion unit is specified by **GS P**.

## TM-L90

The vertical or horizontal motion unit is specified by **GS P**.

When a set value of the paper layout (horizontal and vertical size of the print area) is smaller than the print area (initial value of this command), it is not possible to print in the area where the paper layout (horizontal and vertical size of the print area) is exceeded.

See Function 5 of **GS ( E** for specifying the paper width and paper (monochrome paper or two-color paper).

See Functions 49 and 50 of **GS ( E** for the paper layout (receipt/label paper, horizontal and vertical size of print area).

## TM-P60

[Peeler model]

The maximum value and default value for the horizontal length changes according to the paper layout (horizontal layout). See the **FS ( L <Function 33>** model information for details.

The maximum value and default value for the vertical length changes according to the **GS ( P <Function 48>** setting value. See the **GS ( P <Function 48>** model information for details.

[Other than peeler model]

See Function 5 of **GS ( E** for specifying the paper width.

## ESC \

[Name]	Set relative print position				
[Format]	ASCII	ESC \	<b>nL</b>	<b>nH</b>	
	Hex	1B 5C	<b>nL</b>	<b>nH</b>	
	Decimal	27 92	<b>nL</b>	<b>nH</b>	
[Range]	$-32768 \leq (\mathbf{nL} + \mathbf{nH} \times 256) \leq 32767$				
[Default]	None				
[Printers not featuring this command]	<b>TM-U230, TM-U220</b>				
[Description]	Moves the print position to $(\mathbf{nL} + \mathbf{nH} \times 256) \times$ (horizontal or vertical motion unit) from the current position.				
[Notes]	<ul style="list-style-type: none"> <li>■ The printer ignores any setting that exceeds the print area.</li> <li>■ A positive number specifies movement to the right, and a negative number specifies movement to the left. N pitch movement to the right: <math>(\mathbf{nL} + \mathbf{nH} \times 256) = N</math>. Use the complement of N for setting N pitch movement to the left: <math>(\mathbf{nL} + \mathbf{nH} \times 256) = 65536 - N</math>.</li> <li>■ When standard mode is selected, the horizontal motion unit is used.</li> <li>■ When page mode is selected, the horizontal or vertical motion unit is used for the print direction set by <b>ESC T</b>. <ul style="list-style-type: none"> <li>• When the starting position is set to the upper left or lower right of the print area using <b>ESC T</b>, the horizontal motion unit is used.</li> <li>• When the starting position is set to the upper right or lower left of the print area using <b>ESC T</b>, the vertical motion unit is used.</li> </ul> </li> <li>■ Even if the vertical or horizontal motion unit is changed after changing the print position, the setting of the print position will not be changed.</li> <li>■ When underline mode is turned on, the underline will not be printed under the space skipped by this command.</li> <li>■ “\” corresponds to “\” in the JIS code system.</li> </ul>				
[Model-dependent variations]	<b>TM-J2000/J2100, TM-T90, TM-T88IV, TM-T70, TM-L90</b>				

# CONFIDENTIAL

## Program example for ESC \$ and ESC \

### Program Example

```
PRINT #1, CHR$(&H1D); "P";CHR$(180);CHR$(180);  
PRINT #1, "ABCD";  
PRINT #1, CHR$(&H1B);"$";CHR$(90);CHR$(0); ←Set absolute position  
PRINT #1, "EFGH"; CHR$(&HA);  
PRINT #1, "ABCD";  
PRINT #1, CHR$(&H1B);"\";CHR$(90);CHR$(0); ←Set relative position  
PRINT #1, "EFGH"; CHR$(&HA);
```

### Print Sample

The print sample illustrates the output of the program. It shows two lines of text: "ABCD" and "EFGH". The first line is printed at an absolute position, and the second line is printed at a relative position. A horizontal line with an arrow indicates a distance of 90/180 inch between the start of the first line and the start of the second line. The text "90/180 inch" is printed above and below the line.

**TM-J2000/J2100, TM-T90, TM-T88IV, TM-T70, TM-L90**

**The vertical or horizontal motion unit is specified by GS P.**

## ESC a

[Name] Select justification

[Format] ASCII      ESC a    **n**  
 Hex        1B 61    **n**  
 Decimal    27 97    **n**

[Range]  $0 \leq n \leq 2, 48 \leq n \leq 50$

[Default] **n** = 0

[Printers not featuring this command] None

[Description] In standard mode, aligns all the data in one line to the selected layout, using **n** as follows:

<b>n</b>	<b>Justification</b>
0, 48	Left justification
1, 49	Centered
2, 50	Right justification

- [Notes]
- When standard mode is selected, this command is enabled only when processed at the beginning of the line in standard mode.
  - The justification has no effect in page mode. If this command is processed in page mode, an internal flag is activated, and this flag is enabled when the printer returns to standard mode.
  - This command executes justification in the print area set by **GS L** and **GS W**.
  - This command justifies printing data (such as characters, all graphics, bar codes, and two dimensional codes) and space area set by **HT**, **ESC \$**, and **ESC \**.
  - The settings of this command are effective until **ESC @** is executed, the printer is reset, or the power is turned off.

# CONFIDENTIAL

[Model-dependent variations]

None

## Program Example for all printers

```
FOR n=0 TO 2
  PRINT #1, CHR$(&H1B);"a";CHR$(n);
  PRINT #1, "ABC"; CHR$(&HA);
  PRINT #1, "ABCD"; CHR$(&HA);
  PRINT #1, "ABCDE"; CHR$(&HA);
NEXT n
```

## Print Sample

```
ABC
ABCD
ABCDE ] ESC a 0

      ABC
      ABCD
      ABCDE ] ESC a 1

            ABC
            ABCD
            ABCDE ] ESC a 2
```

## GS \$

[Name] Set absolute vertical print position in page mode

[Format]	ASCII	GS	\$	<b>nL</b>	<b>nH</b>
	Hex	1D	24	<b>nL</b>	<b>nH</b>
	Decimal	29	36	<b>nL</b>	<b>nH</b>

[Range]  $0 \leq \mathbf{nL} \leq 255, 0 \leq \mathbf{nH} \leq 255$

[Default] None

[Printers not featuring this command] **TM-U230, TM-U220**

[Description] In page mode, moves the vertical print position to  $(\mathbf{nL} + \mathbf{nH} \times 256) \times$  (vertical or horizontal motion unit) from the starting position set by **ESC T**.  
 In page mode, moves the vertical print position to  $[(\mathbf{nL} + \mathbf{nH} \times 256) \times$  (vertical or horizontal motion unit)] from the starting position set with ESC T.

- [Notes]
- This command is enabled only in page mode. If this command is processed in standard mode, it is ignored.
  - The printer ignores any setting that exceeds the print area set by **ESC W**.
  - The horizontal or vertical motion unit is used for the print direction set by **ESC T**.
    - When the starting position is set to the upper left or lower right of the print area using **ESC T**, the vertical motion unit is used.
    - When the starting position is set to the upper right or lower left of the print area using **ESC T**, the horizontal motion unit is used.
  - Even if the vertical or horizontal motion unit is changed after changing the print position, the print position will not be changed.

[Model-dependent variations] **TM-J2000/J2100, TM-T90, TM-T88IV, TM-T70, TM-L90, TM-P60**

See program example and print sample for GS \$ and GS \.

**TM-J2000/J2100, TM-T90, TM-T88IV, TM-T70, TM-L90**

The vertical or horizontal motion unit is specified by GS P.

# CONFIDENTIAL

## TM-P60

The vertical or horizontal motion unit is approximately 0.125 mm {1/203 inches}. This value equals one dot pitch.



## GS L

[Name]	Set left margin
[Format]	ASCII    GS L <b>nL</b> <b>nH</b> Hex       1D 4C <b>nL</b> <b>nH</b> Decimal   29 76 <b>nL</b> <b>nH</b>
[Range]	$0 \leq (\mathbf{nL} + \mathbf{nH} \times 256) \leq 65535$ ( $0 \leq \mathbf{nL} \leq 255$ , $0 \leq \mathbf{nH} \leq 255$ )
[Default]	$(\mathbf{nL} + \mathbf{nH} \times 256) = 0$ ( $\mathbf{nL} = 0$ , $\mathbf{nH} = 0$ )
[Printers not featuring this command]	<b>TM-U230</b> , <b>TM-U220</b>
[Description]	In standard mode, sets the left margin to $(\mathbf{nL} + \mathbf{nH} \times 256) \times$ (horizontal motion unit) from the left edge of the printable area.
[Notes]	<ul style="list-style-type: none"> <li>■ When standard mode is selected, this command is enabled only when processed at the beginning of the line.</li> <li>■ The left margin has no effect in page mode. If this command is processed in page mode, the left margin is set and it is enabled when the printer returns to standard mode.</li> <li>■ If the setting exceeds the printable area, the left margin is automatically set to the maximum value of the printable area.</li> <li>■ If this command and <b>GS W</b> set the print area width to less than the width of one character, the print area width is extended to accommodate one character for the line.</li> <li>■ Horizontal motion unit is used.</li> <li>■ If horizontal motion unit is changed after changing left margin, left margin setting is not changed.</li> <li>■ Left margin setting is effective until <b>ESC @</b> is executed, the printer is reset, or the power is turned off.</li> <li>■ Left margin position is left edge of the printable area. If left margin setting is changed, left edge of the printable area will move.</li> </ul>

[Model-dependent variations]        **TM-J2000/J2100**, **TM-T90**, **TM-T88IV**, **TM-T70**, **TM-L90**, **TM-P60**

See program example and print sample for **GS L** and **GS W**.

# C O N F I D E N T I A L

**TM-J2000/J2100, TM-T90, TM-T88IV, TM-T70, TM-L90**

The horizontal motion unit is specified by **GS P**.

**TM-P60**

Horizontal motion unit is about 0.125 mm {1/203 inch}. This corresponds to 1 dot pitch.

## GS T

[Name] Set print position to the beginning of print line

[Format] ASCII GS T **n**  
 Hex 1D 54 **n**  
 Decimal 29 84 **n**

[Range] **n** = 0, 1, 48, 49

[Default] None

[Printers not featuring this command] **TM-T88IV**, **TM-T70**, **TM-P60**, **TM-U230**, **TM-U220**

[Description] In standard mode, moves the print position to the beginning of the print line after performing the operation specified by **n**.

<b>n</b>	<b>Function</b>
0, 48	Cancel data in the current print buffer
1, 49	Print data in the current print buffer

- [Notes]
- In page mode, this command is ignored.
  - This command is ignored if the print position is already the beginning of the line.
  - If the print position is not set to the beginning of the line, when **n** = 1, 49, this command functions the same as **LF**.
  - Setting values of each command, definitions, and receive buffer content are not changed.
  - By processing this command, the print position moves to the left of the print area. The printer will be in the beginning of the line and data will not be in the print buffer.
  - When using commands that are enabled only at the beginning of the line, these commands are sure to be executed if **GS T** is used immediately before using those commands.

[Model-dependent variations]

None

## Program Example

```
PRINT #1, CHR$(&H1D);"T";CHR$(1);  
PRINT #1, CHR$(&H1B);"c0";CHR$(2);  
PRINT #1, CHR$(&H1D);"V"CHR$(66);CHR$(66);
```

[Name]	Set print area width
[Format]	ASCII    GS   W <b>nL</b> <b>nH</b> Hex       1D   57 <b>nL</b> <b>nH</b> Decimal   29   87 <b>nL</b> <b>nH</b>
[Range]	$0 \leq (\mathbf{nL} + \mathbf{nH} \times 256) \leq 65535$ ( $0 \leq \mathbf{nL} \leq 255$ , $0 \leq \mathbf{nH} \leq 255$ )
[Default]	Entire printable area <b>TM-J2000/J2100:</b> <b>nL = 0, nH = 2 (when paper width is set to 82.5 mm)</b> <b>nL = 224, nH = 1 (when paper width is set to 76 mm)</b> <b>nL = 176, nH = 1 (when paper width is set to 69.5 mm)</b> <b>nL = 104, nH = 1 (when paper width is set to 57.5 mm)</b>  <b>TM-T90:</b> [Other than Japanese model] <b>nL = 0, nH = 2 (when paper width is set to 80 mm)</b> <b>nL = 128, nH = 1 (when paper width is set to 60 mm)</b> <b>nL = 104, nH = 1 (when paper width is set to 58 mm)</b> [Japanese model] <b>nL = 64, nH = 2 (when paper width is set to 80 mm)</b> <b>nL = 180, nH = 1 (when paper width is set to 60 mm)</b> <b>nL = 164, nH = 1 (when paper width is set to 58 mm)</b>  <b>TM-T88IV:</b> <b>nL = 0, nH = 2 (when paper width is set to 80 mm)</b> <b>nL = 104, nH = 1 (when paper width is set to 58 mm)</b>  <b>TM-T70:</b> <b>nL = 0, nH = 2 (Other than Japanese model)</b> <b>nL = 160, nH = 1 (Japanese model)</b>  <b>TM-L90:</b> [when receipt is selected] <b>nL = 64, nH = 2 (when paper width is set to 80 mm to 78 mm)</b> <b>256 + (paper width - 38) × 8 (when paper width is set to 77 mm to 38 mm)</b> [when label paper is selected] <b>nL = 48, nH = 2 (when paper width is set to 80 mm)</b> <b>224 + (paper width - 38) × 8 (when paper width is set to 79 mm to 38 mm)</b>  <b>TM-P60:</b> [Peeler model] <b>nL + nH x 256 = 388 (nL = 132, nH = 1)</b>

## [Other than Peeler model]

**nL = 164, nH = 1 (when paper width is set to 58 mm)**

**nL = 176, nH = 1 (when paper width is set to 60 mm)**

[Printers not featuring this command] **TM-U230, TM-U220**

[Description] In standard mode, sets the print area width to  $(nL + nH \times 256) \times$  (horizontal motion unit).

- [Notes]
- When standard mode is selected, this command is enabled only when processed at the beginning of the line.
  - The print area width has no effect in page mode. If this command is processed in page mode, the print area width is set and it is enabled when the printer returns to standard mode.
  - If the [left margin + print area width] exceeds the printable area, the print area width is automatically set to [printable area – left margin].
  - If this command and **GS L** set the print area width to less than the width of one character, the print area width is extended to accommodate one character for the line.
  - Horizontal motion unit is used.
  - If horizontal motion unit is changed after setting the printable area width, the printable area width setting will not be changed.
  - Printable area width setting is effective until **ESC @** is executed, the printer is reset, or the power is turned off.

[Model-dependent variations] **TM-J2000/J2100, TM-T90, TM-T88IV, TM-T70, TM-L90, TM-P60**

## Program example for GS L and GS W

### Program Example

```
PRINT #1, CHR$(&H1D); "P";CHR$(180);CHR$(180);  
PRINT #1, "01234567890123456789"; CHR$(&HA);  
PRINT #1, CHR$(&H1D); "L";CHR$(60);CHR$(0); ← Set left margin  
PRINT #1, CHR$(&H1D); "W";CHR$(120);CHR$(0); ← Set print area width  
PRINT #1, "01234567890123456789"; CHR$(&HA);
```

### Print Sample

```
01234567890123456789  
    0123456789  
      0123456789  
      |-----|  
      Left Printing  
      margin area  
      width
```

### TM-J2000/J2100, TM-T90

The horizontal motion unit is specified by **GS P**.

See **GS ( E Functions 5** for specifying the paper width.

### TM-T88IV, TM-T70

The horizontal motion unit is specified by **GS P**.

### TM-L90

The horizontal motion unit is specified by **GS P**.

When a set value of the paper layout (horizontal size of the print area) is smaller than the print area (initial value of this command), it is not possible to print in the area where the paper layout (horizontal size of the print area) is exceeded.

See **GS ( E Functions 5** for specifying the paper width.

See **GS ( E Functions 49 and 50** for the paper layout (origin of layout, horizontal size of print area).

## **TM-P60**

**[Peeler specification]**

**The maximum value and default value for the printing area width changes according to the paper layout (horizontal layout). See the FS ( L <Function 33> model information for details.**

**[Other than Peeler model]**

**See GS ( E Function 5 for specifying the paper width.**



## GS \

[Name]	Set relative vertical print position in page mode				
[Format]	ASCII	GS \	<b>nL</b>	<b>nH</b>	
	Hex	1D 5C	<b>nL</b>	<b>nH</b>	
	Decimal	29 92	<b>nL</b>	<b>nH</b>	
[Range]	$-32768 \leq (\mathbf{nL} + \mathbf{nH} \times 256) \leq 32767$				
[Default]	None				
[Printers not featuring this command]	<b>TM-U230, TM-U220</b>				
[Description]	In page mode, moves the vertical print position to $(\mathbf{nL} + \mathbf{nH} \times 256) \times$ (vertical or horizontal motion unit) from the current position.				
[Notes]	<ul style="list-style-type: none"> <li>■ This command is enabled only in page mode. If this command is processed in standard mode, it is ignored.</li> <li>■ The printer ignores any setting that exceeds the print area set by <b>ESC W</b>.</li> <li>■ A positive number specifies movement downward, and a negative number specifies movement upward. N pitch movement downward: <math>(\mathbf{nL} + \mathbf{nH} \times 256) = N</math>. Use the complement of N for setting N pitch movement upward: <math>(\mathbf{nL} + \mathbf{nH} \times 256) = 65536 - N</math>.</li> <li>■ The horizontal or vertical motion unit is used for the print direction set by <b>ESC T</b>. <ul style="list-style-type: none"> <li>• When the starting position is set to the upper left or lower right of the print area using <b>ESC T</b>, the vertical motion unit is used.</li> <li>• When the starting position is set to the upper right or lower left of the print area using <b>ESC T</b>, the horizontal motion unit is used.</li> </ul> </li> <li>■ Even if vertical or horizontal motion unit is changed after changing the print position, the setting of print position will not be changed.</li> <li>■ “\” is corresponds to “\” in JIS code set.</li> </ul>				
[Model-dependent variations]	<b>TM-J2000/J2100, TM-T90, TM-T88IV, TM-T70, TM-L90, TM-P60</b>				

# CONFIDENTIAL

## Program example for GS \$ and GS \

### Program Example

```
PRINT #1, CHR$(&H1B);"L"; ←Select page mode
PRINT #1, CHR$(&H1D);"P";CHR$(180);CHR$(180);
PRINT #1, CHR$(&H1B);"W";CHR$(0);CHR$(0);CHR$(0);CHR$(0);
CHR$(180);CHR$(0);CHR$(144);CHR$(1); ←Set print area
PRINT #1, CHR$(&H1B);"T";CHR$(0); ←Select print direction
PRINT #1, "AAAAA"; CHR$(&HA);
PRINT #1, "BBBBB";
PRINT #1, CHR$(&H1D);"$";CHR$(90);CHR$(0); ←Set absolute position
PRINT #1, "CCCCC"; CHR$(&HA);
PRINT #1, "DDDDD"; CHR$(&HA);
PRINT #1, "EEEEE";
PRINT #1, CHR$(&H1D);"\";CHR$(90);CHR$(0); ←Set relative position
PRINT #1, "FFFFF"; CHR$(&HC); ←Batch print and return to standard mode
```

### Print Sample

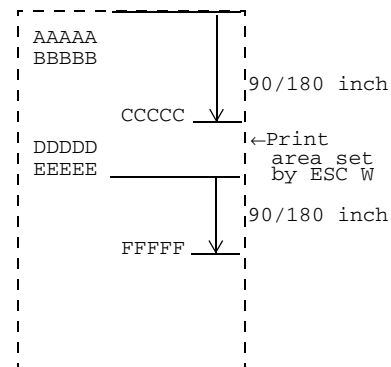

**TM-J2000/J2100, TM-T90, TM-T88IV, TM-T70, TM-L90**

**The vertical or horizontal motion unit is specified by GS P.**

**TM-P60**

**The vertical or horizontal motion unit is approximately 0.125 mm {1/203 inches}. This value equals one dot pitch.**

## BIT IMAGE COMMANDS

Command	Name
<b>ESC *</b>	Select bit-image mode
<b>FS p</b>	Print NV bit image
<b>GS ( L</b>	Set graphics data
<b>GS 8 L</b>	Transmit the NV graphics memory capacity.
	Set the reference dot density for graphics.
	Print the graphics data in the print buffer.
	Transmit the remaining capacity of the NV graphics memory.
	Transmit the remaining capacity of the download graphics memory.
	Transmit the key code list for defined NV graphics.
	Delete all NV graphics data.
	Delete the specified NV graphics data.
	Define the NV graphics data (raster format).
	Define the NV graphics data (column format).
	Print the specified NV graphics data.
	Transmit the key code list for defined download graphics.
	Delete all NV graphics data.
	Delete the specified download graphics data.
	Define the downloaded graphics data (raster format).
	Define the downloaded graphics data (column format).
	Print the specified download graphics data.
	Store the graphics data in the print buffer (raster format).
	Store the graphics data in the print buffer (column format).
<b>FS q</b>	Define NV bit image
<b>GS v 0</b>	Print raster bit image
<b>GS *</b>	Define downloaded bit image
<b>GS /</b>	Print downloaded bit image
<b>GS Q 0</b>	Print variable vertical size bit image

## ESC \*

[Name]	Select bit-image mode
[Format]	ASCII    ESC * <b>m</b> <b>nL</b> <b>nH</b> <b>d1 ... dk</b> Hex        1B 2A <b>m</b> <b>nL</b> <b>nH</b> <b>d1 ... dk</b> Decimal   27 42 <b>m</b> <b>nL</b> <b>nH</b> <b>d1 ... dk</b>
[Range]	<b>TM-J2000/J2100, TM-T90, TM-L90:</b> <b>m = 0, 1, 32, 33</b> <b><math>1 \leq (nL + nH \times 256) \leq 1023</math> (<math>0 \leq nL \leq 255</math>)</b> <b><math>0 \leq d \leq 255</math></b> <b>k = nL + nH × 256 [in case of m = 0, 1]</b> <b>k = (nL + nH × 256) × 3 [in case of m = 32, 33]</b>  <b>TM-T88IV, TM-T70:</b> <b>m = 0, 1, 32, 33</b> <b><math>1 \leq (nL + nH \times 256) \leq 2047</math> (<math>0 \leq nL \leq 255, 0 \leq nH \leq 7</math>)</b> <b><math>0 \leq d \leq 255</math></b> <b>k = nL + nH × 256 [in case of m = 0, 1]</b> <b>k = (nL + nH × 256) × 3 [in case of m = 32, 33]</b>  <b>TM-U230, TM-U220:</b> <b>m = 0, 1</b> <b><math>1 \leq (nL + nH \times 256) \leq 2047</math> (<math>0 \leq nL \leq 255, 0 \leq nH \leq 3</math>)</b> <b><math>0 \leq d \leq 255</math></b> <b>k = nL + nH × 256</b>
[Default]	None
[Printers not featuring this command]	<b>TM-P60</b>

[Description]

Stores the bit image data in the print buffer using the mode specified by bit image mode **m** as follows:

<b>m</b>	<b>Bit image Mode</b>	<b>Number of bits for vertical data</b>	<b>Dot density in horizontal</b>
0	8-dot single-density	8	Single-density
1	8-dot double-density	8	Double-density
32	24-dot single-density	24	Single-density
33	24-dot double-density	24	Double-density

- **nL**, **nH** specifies a bit image in the horizontal direction as  $(nL + nH \times 256)$  dots.
- **d** specifies the bit image data (column format).
- **k** indicates the amount of bit image data. **k** is an explanation parameter; therefore it does not need to be transmitted.

[Notes]

- Data (**d**) specifies a bit printed to 1 and not printed to 0.
- If the bit image data exceeds the number of dots to be printed on a line, the excess data is ignored.
- The bit-image is not affected by print mode (emphasized, double-strike, underline, character size, white/black reverse printing, or 90° clockwise-rotated), except for upside-down print mode.
- After printing a bit image, the printer processes normal data.
- When printing multiple line bit images, selecting unidirectional print mode with **ESC U** enables printing patterns in which the top and bottom parts are aligned vertically.
- This command is used to print a picture or logo.
- The relationship between the bit image data and the print result is as follows.

8 dot mode ( $m = 0, 1$ )

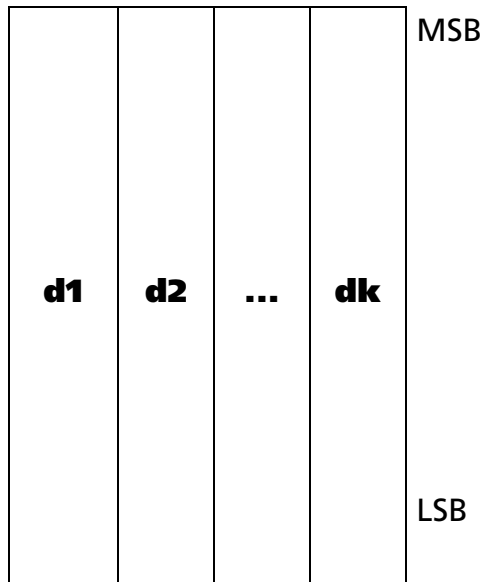

24 dot mode ( $m = 32, 33$ )

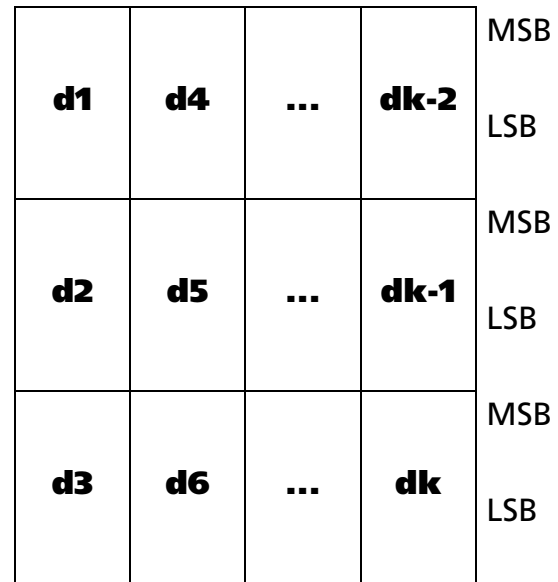

[Model-dependent variations]

**TM-J2000/J2100, TM-T90, TM-T88IV, TM-T70, TM-L90, TM-U230, TM-U220**

```

Program Example for all printers

m=0:  GOSUB bitimage8 ←8-dot single-density
m=1:  GOSUB bitimage8 ←8-dot double-density
END

bitimage8:
  PRINT #1, CHR$ (&H1B); "*" ;CHR$ (m);CHR$ (70);CHR$ (0);
  FOR i=1 TO 5
    PRINT #1, CHR$ (1);CHR$ (2);CHR$ (4);CHR$ (8);
    PRINT #1, CHR$ (16);CHR$ (32);CHR$ (64);CHR$ (128);
    PRINT #1, CHR$ (64);CHR$ (32);CHR$ (16);CHR$ (8);
    PRINT #1, CHR$ (4);CHR$ (2);
  NEXT i
  PRINT #1, CHR$ (&HA);
  RETURN
    
```

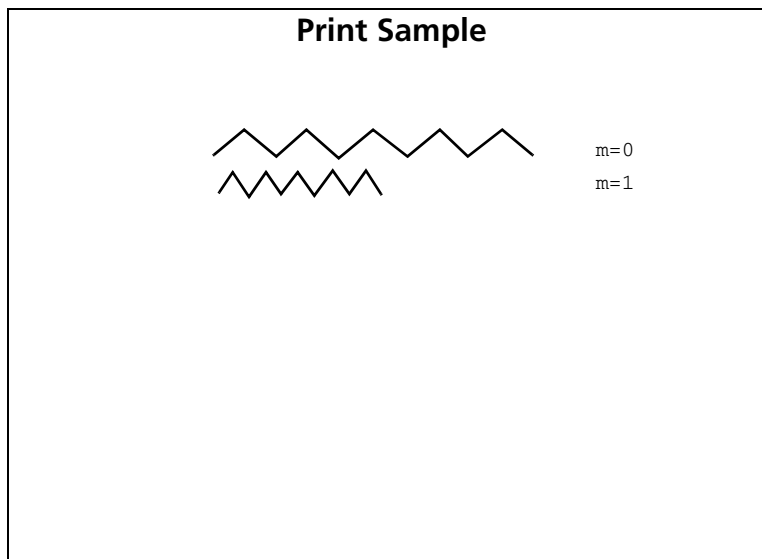

## TM-J2000 (single-color printing model)

The bit image modes selectable by **m** are as follows:

“Vertical” is in the direction of paper feeding and “horizontal” is perpendicular (at right angles) to the direction of paper feeding.

See Function 5 of **GS E** for specifying the paper.

When both standard mode and page mode are selected (a starting position specified by **ESC T** is upper left or lower right).

m	Bit Image Mode	Vertical dot density	Horizontal					
			Dot density	Set adjacent dots	Maximum number of dots			
					Paper width 82.5 mm	Paper width 76 mm	Paper width 69.5 mm	Paper width 57.5 mm
0	8-dot single-density	60 dpi	90 dpi	Permitted	256	240	216	180

m	Bit Image Mode	Vertical dot density	Horizontal					
			Dot density	Set adjacent dots	Maximum number of dots			
					Paper width 82.5 mm	Paper width 76 mm	Paper width 69.5 mm	Paper width 57.5 mm
1	8-dot double-density	60 dpi	180 dpi	Permitted	512	480	432	360
32	24-dot single-density	180 dpi	90 dpi	Permitted	256	240	216	180
33	24-dot double-density	180 dpi	180 dpi	Permitted	512	480	432	360

When the starting position specified by **ESC T** is upper right or lower left in page mode.

m	Bit Image Mode	Vertical						Horizontal dot density
		Dot density	Set adjacent dots	Maximum number of dots				
				Paper width 82.5 mm	Paper width 76 mm	Paper width 69.5 mm	Paper width 57.5 mm	
0	8-dot single-density	90 dpi	Permitted	416	444	492	592	60 dpi
1	8-dot double-density	180 dpi	Permitted	832	888	984	1184	60 dpi
32	24-dot single-density	90 dpi	Permitted	416	444	492	592	180 dpi
33	24-dot double-density	180 dpi	Permitted	832	888	984	1184	180 dpi

90° or 270° rotated bit-image data will be printed.

dpi: dots per 25.4 mm (dots per inch)



# CONFIDENTIAL

## TM-J2100 (two-color printing model)

The bit image modes selectable by **m** are as follows:

When both standard mode and page mode are selected (a starting position specified by **ESC T** is upper left or lower right).

m	Bit Image Mode	Vertical dot density	Horizontal					
			Dot density	Set adjacent dots	Maximum number of dots			
					Paper width 82.5 mm	Paper width 76 mm	Paper width 69.5 mm	Paper width 57.5 mm
0	8-dot single-density	60 dpi	90 dpi	Permitted	256	240	216	180
1	8-dot double-density	60 dpi	180 dpi	Permitted	512	480	432	360
32	24-dot single-density	180 dpi	90 dpi	Permitted	256	240	216	180
33	24-dot double-density	180 dpi	180 dpi	Permitted	512	480	432	360

When the starting position specified by **ESC T** is upper right or lower left in page mode.

m	Bit Image Mode	Vertical						Horizontal dot density
		Dot density	Set adjacent dots	Maximum number of dots				
				Paper width 82.5 mm	Paper width 76 mm	Paper width 69.5 mm	Paper width 57.5 mm	
0	8-dot single-density	90 dpi	Permitted	320	340	380	456	60 dpi
1	8-dot double-density	180 dpi	Permitted	640	680	760	912	60 dpi
32	24-dot single-density	90 dpi	Permitted	340	380	456	592	180 dpi
33	24-dot double-density	180 dpi	Permitted	640	680	760	912	180 dpi

90° or 270° rotated bit-image data will be printed.

dpi: dots per 25.4 mm (dots per inch)

# CONFIDENTIAL

## TM-T90

The bit image modes selectable by **m** are as follows:

“Vertical” is in the direction of paper feeding and “horizontal” is perpendicular (at right angles) to the direction of paper feeding.

See Functions 5 and 6 of **GS ( E** to specify the paper width.

When both standard mode and page mode are selected (a starting position specified by **ESC T** is upper left or lower right).

[Other than Japanese model]

When the starting position specified by **ESC T** is lower right or upper left in page mode or standard mode

<b>m</b>	<b>Bit Image Mode</b>	<b>Vertical dot density</b>	<b>Horizontal</b>				
			<b>Dot density</b>	<b>Set adjacent dots</b>	<b>Maximum number of dots</b>		
					<b>Paper width 80 mm</b>	<b>Paper width 60 mm</b>	<b>Paper width 58 mm</b>
<b>0</b>	<b>8-dot single-density</b>	<b>60 dpi</b>	<b>90 dpi</b>	<b>Permitted</b>	<b>256</b>	<b>192</b>	<b>180</b>
<b>1</b>	<b>8-dot double-density</b>	<b>60 dpi</b>	<b>180 dpi</b>	<b>Permitted</b>	<b>512</b>	<b>384</b>	<b>360</b>
<b>32</b>	<b>24-dot single-density</b>	<b>180 dpi</b>	<b>90 dpi</b>	<b>Permitted</b>	<b>256</b>	<b>192</b>	<b>180</b>
<b>33</b>	<b>24-dot double-density</b>	<b>180 dpi</b>	<b>180 dpi</b>	<b>Permitted</b>	<b>512</b>	<b>384</b>	<b>360</b>

When the starting position specified by **ESC T** is upper right or lower left in page mode.

<b>m</b>	<b>Bit Image Mode</b>	<b>Vertical</b>			<b>Horizontal dot density</b>
		<b>Dot density</b>	<b>Set adjacent dots</b>	<b>Maximum number of dots</b>	
<b>0</b>	<b>8-dot single-density</b>	<b>90 dpi</b>	<b>Permitted</b>	<b>415</b>	<b>60 dpi</b>
<b>1</b>	<b>8-dot double-density</b>	<b>180 dpi</b>	<b>Permitted</b>	<b>831</b>	<b>60 dpi</b>
<b>32</b>	<b>24-dot single-density</b>	<b>90 dpi</b>	<b>Permitted</b>	<b>415</b>	<b>180 dpi</b>
<b>33</b>	<b>24-dot double-density</b>	<b>180 dpi</b>	<b>Permitted</b>	<b>831</b>	<b>180 dpi</b>

# CONFIDENTIAL

90° or 270° rotated bit-image data will be printed.

dpi: dots per 25.4 mm (dots per inch)

[Japanese model]

m	Bit Image Mode	Vertical dot density	Horizontal				
			Dot density	Set adjacent dots	Maximum number of dots		
					Paper width 82.5 mm	Paper width 76 mm	Paper width 70 mm
0	8-dot single-density	203/3 dpi	203/2 dpi	Permitted	288	218	210
1	8-dot double-density	203/3 dpi	203 dpi	Permitted	576	436	420
32	24-dot single-density	203 dpi	203/2 dpi	Permitted	288	218	210
33	24-dot double-density	203 dpi	203 dpi	Permitted	576	436	420

When the starting position specified by **ESC T** is upper right or lower left in page mode.

m	Bit Image Mode	Vertical			Horizontal dot density
		Dot density	Set adjacent dots	Maximum number of dots	
0	8-dot single-density	203/2 dpi	Permitted	415	203/3 dpi
1	8-dot double-density	203 dpi	Permitted	831	203/3 dpi
32	24-dot single-density	203/2 dpi	Permitted	415	203 dpi
33	24-dot double-density	203 dpi	Permitted	831	203 dpi

90° or 270° rotated bit-image data will be printed.

dpi: dots per 25.4 mm (dots per inch)

## TM-T88IV

The bit image modes selectable by **m** are as follows:

When both standard mode and page mode are selected (a starting position specified by **ESC T** is upper left or lower right).

<b>m</b> Bit Image Mode		Vertical dot density	Horizontal			
			Dot density	Set adjacent dots	Maximum number of dots	
					Paper width 80 mm	Paper width 58 mm
<b>0</b>	<b>8-dot single-density</b>	<b>60 dpi</b>	<b>90 dpi</b>	<b>Permitted</b>	<b>256</b>	<b>180</b>
<b>1</b>	<b>8-dot double-density</b>	<b>60 dpi</b>	<b>180 dpi</b>	<b>Permitted</b>	<b>512</b>	<b>360</b>
<b>32</b>	<b>24-dot single-density</b>	<b>180 dpi</b>	<b>90 dpi</b>	<b>Permitted</b>	<b>256</b>	<b>180</b>
<b>33</b>	<b>24-dot double-density</b>	<b>180 dpi</b>	<b>180 dpi</b>	<b>Permitted</b>	<b>512</b>	<b>360</b>

When the starting position specified by **ESC T** is upper right or lower left in page mode.

<b>m</b> Bit Image Mode		Vertical				Horizontal dot density
		Dot density	Set adjacent dots	Maximum number of dots		
				Single-color printing control	Two-color printing control	
<b>0</b>	<b>8-dot single-density</b>	<b>90 dpi</b>	<b>Permitted</b>	<b>831</b>	<b>415</b>	<b>60 dpi</b>
<b>1</b>	<b>8-dot double-density</b>	<b>180 dpi</b>	<b>Permitted</b>	<b>1662</b>	<b>831</b>	<b>60 dpi</b>
<b>32</b>	<b>24-dot single-density</b>	<b>90 dpi</b>	<b>Permitted</b>	<b>831</b>	<b>415</b>	<b>180 dpi</b>
<b>33</b>	<b>24-dot double-density</b>	<b>180 dpi</b>	<b>Permitted</b>	<b>1662</b>	<b>831</b>	<b>180 dpi</b>

90° or 270° rotated bit-image data will be printed.

dpi: dots per 25.4 mm (dots per inch)

# CONFIDENTIAL

## TM-T70

The bit image modes selectable by **m** are as follows:

When both standard mode and page mode are selected (a starting position specified by **ESC T** is upper left or lower right).

m	Bit Image Mode	Vertical		Horizontal				
		Dot density		Dot density		Set adjacent dots	Maximum number of dots	
		Other than Japanese model	Japanese model	Other than Japanese model	Japanese model		Other than Japanese model	Japanese model
0	8-dot single-density	60 dpi	203/3 dpi	90 dpi	203/2 dpi	Permitted	256	208
1	8-dot double-density	60 dpi	203/3 dpi	180 dpi	203 dpi	Permitted	512	416
32	24-dot single-density	180 dpi	203 dpi	90 dpi	203/2 dpi	Permitted	256	208
33	24-dot double-density	180 dpi	203 dpi	180 dpi	203 dpi	Permitted	512	416

When the starting position specified by **ESC T** is upper right or lower left in page mode.

m	Bit Image Mode	Vertical				Horizontal	
		Dot density		Set adjacent dots	Maximum number of dots	Dot density	
		Other than Japanese model	Japanese model			Other than Japanese model	Japanese model
0	8-dot single-density	90 dpi	203/2 dpi	Permitted	831	60 dpi	203/3 dpi

m	Bit Image Mode	Vertical				Horizontal	
		Dot density		Set adjacent dots	Maximum number of dots	Dot density	
		Other than Japanese model	Japanese model			Other than Japanese model	Japanese model
1	8-dot double-density	180 dpi	203 dpi	Permitted	1662	60 dpi	203/3 dpi
32	24-dot single-density	90 dpi	203/2 dpi	Permitted	831	180 dpi	203 dpi
33	24-dot double-density	180 dpi	203 dpi	Permitted	1662	180 dpi	203 dpi

90° or 270° rotated bit-image data will be printed.

dpi: dots per 25.4 mm (dots per inch)

## TM-L90

The bit image modes selectable by **m** are as follows:

“Vertical” is in the direction of paper feeding and “horizontal” is perpendicular (at right angles) to the direction of paper feeding.

See Function 5 of **GS ( E** for specifying the paper width.

See Functions 49 and 50 of **GS ( E** for specifying the origin of layout (paper layout is not used / top of a black mark / bottom of a label).

# CONFIDENTIAL

When both standard mode and page mode are selected (a starting position specified by ESC T is upper left or lower right).

m	Bit Image Mode	Vertical dot density	Horizontal			
			Dot density	Set adjacent dots	Maximum number of dots	
					Paper layout is not used / Top of a black mark	Bottom of a label
0	8-dot single-density	203/3 dpi	203/2 dpi	Permitted	128 to 288	112 to 280
1	8-dot double-density	203/3 dpi	203 dpi	Permitted	256 to 576	224 to 560
32	24-dot single-density	203 dpi	203/2 dpi	Permitted	128 to 288	112 to 280
33	24-dot double-density	203 dpi	203 dpi	Permitted	256 to 576	224 to 560

A horizontal maximum print area is decided according to the width of the paper.

When paper layout is not used or top of black mark is selected.

Paper width	Single density mode (m = 0, 32)	Double density mode (m = 1, 33)
80 mm to 78 mm	288 dots	576 dots
77 mm to 38 mm	$(256 + (\text{paper width} - 38) \times 8 / 2)$ dots	$(256 + (\text{paper width} - 38) \times 8)$ dots

When paper layout is selected as the bottom of label.

Paper width	Single density mode (m = 0, 32)	Double density mode (m = 1,33)
80 mm	280 dots	560 dots
79 mm to 38 mm	$(224 + (\text{paper width} - 38) \times 8 / 2)$ dots	$(224 + (\text{paper width} - 38) \times 8)$ dots

# CONFIDENTIAL

When the starting position specified by ESC T is upper right or lower left in page mode.

m	Bit Image Mode	Vertical			Horizontal dot density
		Dot density	Set adjacent dots	Maximum number of dots	
0	8-dot single-density	203/2 dpi	Permitted	738	203/3 dpi
1	8-dot double-density	203 dpi	Permitted	1476	203/3 dpi
32	24-dot single-density	203/2 dpi	Permitted	738	203 dpi
33	24-dot double-density	203 dpi	Permitted	1476	203 dpi

90° or 270° rotated bit-image data will be printed.

## TM-U230

The bit image modes selectable by m are as follows:

“Vertical” is in the direction of paper feeding and “horizontal” is perpendicular (at right angles) to the direction of paper feeding.

m	Bit Image Mode	Vertical dot density	Horizontal		
			Dot density	Set adjacent dots	Maximum number of dots
0	8-dot single-density	72 dpi	80 dpi	Permitted	200
1	8-dot double-density	72 dpi	160 dpi	Prohibited	400

dpi: dots per 25.4 mm (dots per inch)



## TM-U220

The bit image modes selectable by **m** are as follows:

- “Vertical” is in the direction of paper feeding and “horizontal” is perpendicular (at right angles) to the direction of paper feeding.
- The maximum number of dots for printing depends on a DIP switch [SW2-1] setting and paper width. See the description of **GS ( E <Function 5>** for details.

m	Bit Image Mode	Vertical dot density	Horizontal			
			Dot density	Set adjacent dots	Maximum number of dots	
					SW2-1: ON	SW 2-1: OFF
					Paper Width: 76/ 69.5/ 57.5 (mm)	Paper Width 76/ 69.5/ 57.5 (mm)
0	8-dot single-density	72 dpi	80 dpi	Permitted	192/ 180/ 148	200/ 180/ 150
1	8-dot double-density	72 dpi	160 dpi	Prohibited	385/ 360 / 297	400/ 360/ 300

**dpi: dots per 25.4 mm (dots per inch)**

## FS p

[Name] Print NV bit image

[Format] ASCII FS p **n m**  
 Hex 1C 70 **n m**  
 Decimal 28 112 **n m**

[Printers not featuring this command] **TM-T70, TM-L90, TM-P60, TM-U230**

[Range]  $1 \leq n \leq 255$   
**TM-J2000/J2100, TM-T90, TM-T88IV:  $0 \leq m \leq 3, 48 \leq m \leq 51$**   
**TM-U220:  $m = 0, 1, 48, 49$**

[Description] Prints NV bit image **n** using the process of **FS q** and using the mode specified by **m**.

<b>m</b>	<b>Mode</b>	<b>Scaling for horizontal</b>	<b>Scaling for vertical</b>
0, 48	Normal	× 1	× 1
1, 49	Double-width	× 2	× 1
2, 50	Double-height	× 1	× 2
3, 51	Quadruple	× 2	× 2

### [Recommended Functions]

This function is supported only by some printer models and may not be supported by future models. It is recommended that NV graphics function (**GS ( L GS 8 L: <Function 51>** and <Function 64> ~ <Function 69>) be used because they offer the following additional features:

- Multiple logo data and mark data can be specified (except for some models).
- Data can be controlled by key code.
- Redefining or deleting the same data is possible for each key code.
- Color can be specified for the definition data.
- Data can be defined by raster format.
- The remaining capacity of the definition area can be confirmed.

# CONFIDENTIAL

- [Notes]
- This command is not effective when the NV bit image specified by **n** has not been defined.
  - In standard mode, this command is effective only when there is no data in the print buffer and the printer is at the beginning of the line.
  - In page mode, the NV bit image is only stored in the print buffer and is not printed.
  - If the NV bit image exceeds one line of print area, the printer does not print it.
  - The scales for width and height of NV bit images are specified by **m**. Therefore, in page mode with 90° or 270° clockwise-rotated NV bit image, the printer applies print area and dot density from [width: direction of paper feed, height: perpendicular to direction of paper feed].
  - This command is not affected by print modes (such as emphasized, underline, character size, or 90° rotated characters), except upside-down print mode.
  - This command executes paper feed for amount needed for printing the NV bit image regardless of paper feed amount set by a paper feed setting command.
  - After printing the bit image, this command sets the print position to the beginning of the line.
  - When printing the NV bit image, selecting unidirectional print mode with **ESC U** enables printing patterns in which the top and bottom parts are aligned vertically.
  - The NV bit image is defined by **FS q**.
  - NV bit image is printed in the default dot density (dot density of vertical and horizontal direction in normal mode) defined by **GS L** <Function 49>.

[Model-dependent variations] **TM-J2000/J2100, TM-T90, TM-T88IV, TM-U220**

## Program example and print sample for FS q and FS p

### Program Example

```

Definition
PRINT #1,
CHR$( &H1C ); "q"; CHR$( 1 ); CHR$( 18 ); CHR$( 0 ); CHR$( 5 ); CHR$( 0 );
FOR i=1 TO 18*5*8
  READ a$: d=VAL("&H"+a$)
  PRINT #1, CHR$(d);
NEXT i

PRINT #1, CHR$( &H1B ); "U"; CHR$( 1 ); ←Select direction
PRINT #1, CHR$( &H1C ); "p"; CHR$( 0 ); CHR$( &HA ); ←Normal
PRINT #1, CHR$( &H1C ); "p"; CHR$( 1 ); CHR$( &HA ); ←Double width

DATA AA,AA,AA,AA,AA,55,55,55,55,54,80,00,00,00,02
DATA 40,00,00,00,04,80,00,00,00,02,40,00,00,00,04
DATA 8A,AA,AA,AA,A2,45,55,55,55,44,8A,AA,AA,AA,A2
DATA 45,55,55,55,44,8A,AA,AA,AA,A2,45,00,50,01,44
DATA 8A,80,A8,02,A2,45,00,50,01,44,8A,80,A8,02,A2
DATA 45,00,50,01,44,8A,80,A8,02,A2,45,00,50,01,44
DATA 8A,80,A8,02,A2,45,00,00,01,44,8A,80,00,02,A2
DATA 40,00,00,00,04,80,00,00,00,02,40,00,00,00,04
DATA 80,AA,00,02,A2,41,55,00,01,44,82,AA,80,02,A2
DATA 45,55,40,01,44,8A,AA,A0,02,A2,45,45,50,01,44
DATA 8A,82,A8,02,A2,45,01,54,01,44,8A,80,AA,02,A2
DATA 45,00,55,01,44,8A,80,2A,82,A2,45,00,15,55,44
DATA 8A,80,0A,AA,A2,45,00,05,55,44,8A,80,02,AA,82
DATA 40,00,01,55,04,80,00,00,00,02,40,00,00,00,04
DATA 80,00,00,00,02,40,15,55,50,04,80,2A,AA,A8,02
DATA 40,55,55,54,04,80,AA,AA,AA,02,41,55,55,55,04
DATA 82,A8,00,2A,82,45,50,00,15,44,8A,A0,00,0A,A2
DATA 45,40,00,05,44,8A,80,00,02,A2,45,00,00,01,44
DATA 8A,80,00,02,A2,45,00,00,01,44,8A,80,00,02,A2
DATA 45,00,00,01,44,8A,80,00,02,A2,40,00,00,00,04
DATA 80,00,00,00,02,40,00,00,00,04,80,00,00,00,62
DATA 40,00,00,03,84,80,00,00,1C,02,40,00,00,60,04
DATA 80,00,03,80,02,40,00,1C,00,04,80,00,60,00,02
DATA 40,03,80,00,04,80,0C,00,00,02,40,70,00,00,04
    
```

### Program Example (continued)

```

DATA 83,80,00,00,02,4C,00,00,00,04,80,00,00,00,02
DATA 40,00,00,00,04,80,00,00,00,02,4A,AA,AA,AA,A4
DATA 85,55,55,55,42,4A,AA,AA,AA,A4,85,55,55,55,42
DATA 4A,AA,AA,AA,A4,85,00,05,00,02,4A,08,0A,80,04
DATA 85,00,05,00,02,4A,80,0A,80,04,85,00,05,00,02
DATA 4A,80,0A,80,04,85,00,05,00,02,4A,80,0A,80,04
DATA 85,55,55,00,02,42,AA,AA,00,04,81,55,54,00,02
DATA 40,AA,A8,00,04,80,55,50,00,02,40,00,00,00,04
DATA 80,00,00,00,02,40,00,00,00,04,80,2A,AA,A8,02
DATA 40,55,55,54,04,80,AA,AA,AA,02,41,55,55,55,04
DATA 82,AA,AA,AA,82,45,40,00,05,44,8A,80,00,02,A2
DATA 45,00,00,01,44,8A,80,00,02,A2,45,00,00,01,44
DATA 8A,80,00,02,A2,45,00,00,01,44,8A,80,00,02,A2
DATA 45,00,00,01,44,8A,80,00,02,A2,45,40,00,05,44
DATA 82,AA,AA,AA,82,41,55,55,55,04,80,AA,AA,AA,02
DATA 40,55,55,54,04,80,2A,AA,A8,02,40,00,00,00,04
DATA 80,00,00,00,02,40,00,00,00,04,80,AA,00,02,A2
DATA 41,55,00,01,44,82,AA,80,02,A2,45,55,40,01,44
DATA 8A,AA,A0,02,A2,45,45,50,01,44,8A,82,A8,02,A2
DATA 45,01,54,01,44,8A,80,AA,02,A2,45,00,55,01,44
DATA 8A,80,2A,82,A2,45,00,15,55,44,8A,80,0A,AA,A2
DATA 45,00,05,55,44,8A,80,02,AA,82,40,00,01,55,04
DATA 80,00,00,00,02,40,00,00,00,04,80,00,00,00,02
DATA 40,00,00,00,04,AA,AA,AA,AA,AA,55,55,55,55,54
    
```

### Print Sample



← Normal mode



← Double-width mode

## TM-J2000/J2100, TM-T90, TM-T88IV

These printers support the graphics functions of **GS ( L/GS 8 L**.

It is recommended that **GS ( L /GS 8 L** be used.

Values of [Dot density] and [Maximum print area (dot)] are the same as the graphic function. (See Function 69 of **GS ( L/GS 8 L**.)

## TM-U220

The modes selectable by **m** are as follows:

- “Vertical” is in the direction of paper feeding and “horizontal” is perpendicular (at right angles) to the direction of paper feeding.
- The maximum number of dots for printing depends on the setting of DIP switch [SW2-1] and paper width. See the description of **GS ( E <Function 5>** for details.

	Vertical	Horizontal		
			Maximum number of dots	
			SW2-1: ON	SW 2-1: OFF
Scaling	Dot density	Dot density	Paper Width: 76/ 69.5/ 57.5 (mm)	Paper Width 76/ 69.5/ 57.5 (mm)
× <b>1</b>	72 dpi	160 dpi	385/ 360 / 297	400/ 360/ 300
× <b>2</b>	--	80 dpi	192/ 180/ 148	200/ 180/ 150

**dpi: dots per 25.4 mm (dots per inch)**

[Name] Set graphics data

[Printers not featuring this command] **TM-U230, TM-U220**

[Description] Processes graphics data.

- Function code (**fn**) specifies the function.

<b>fn</b>	<b>Function No.</b>	<b>Function name</b>
0, 48	<b>Function 48</b>	Transmit the NV graphics memory capacity.
1, 49	<b>Function 49</b>	Set the reference standard dot density for graphics.
2, 50	<b>Function 50</b>	Print the graphics data in the print buffer.
3, 51	<b>Function 51</b>	Transmit the remaining capacity of the NV graphics memory.
4, 52	<b>Function 52</b>	Transmit the remaining capacity of the download graphics memory.
64	<b>Function 64</b>	Transmit the key code list for defined NV graphics.
65	<b>Function 65</b>	Delete all NV graphics data.
66	<b>Function 66</b>	Delete the specified NV graphics data.
67	<b>Function 67</b>	Define the NV graphics data (raster format).
68	<b>Function 68</b>	Define the NV graphics data (column format).
69	<b>Function 69</b>	Print the specified NV graphics data.
80	<b>Function 80</b>	Transmit the key code list for defined download graphics.
81	<b>Function 81</b>	Delete all NV graphics data.
82	<b>Function 82</b>	Delete the specified download graphics data.
83	<b>Function 83</b>	Define the downloaded graphics data (raster format).
84	<b>Function 84</b>	Define the downloaded graphics data (column format).
85	<b>Function 85</b>	Print the specified download graphics data.

<b>fn</b>	<b>Function No.</b>	<b>Function name</b>
112	<b>Function 112</b>	Store the graphics data in the print buffer (raster format).
113	<b>Function 113</b>	Store the graphics data in the print buffer (column format).

- **pL, pH** specifies ( $pL + pH \times 256$ ) as the number of bytes after **pH** (**m, fn**, and **[parameters]**).
  - **p1, p2, p3**, and **p4** specify ( $p1 + p2 \times 256 + p3 \times 65536 + p4 \times 16777216$ ) as the number of bytes after **pH** (**m, fn**, and **[parameters]**).
  - Description of the **[parameters]** is described in each function.
- Differences between **GS ( L** and **GS 8 L**
- All commands possess the same functions for "Graphics data processing."
  - Specifications (conventions) concerning function code (**fn**) are identical, while only the parameters (**pL, pH, p1, p2, p3**, and **p4**) used to specify the parameter values from **m** differ.

<b>Command</b>	<b>Description</b>
<b>GS ( L</b>	Parameter value is 2 bytes less than that for <b>GS 8 L</b> . Used to fix the parameter value. Used when sending data divided into blocks.
<b>GS 8 L</b>	Possesses powerful range of expression. Used for batch transfer of large volumes of data.

- Be sure to use **GS 8 L** when the parameter value exceeds 65535 bytes for Functions 67, 68, 83, 84, 112, and 113.

## [Recommended Functions]

- This command is recommended for use when printing image data.
- The image processing controlled using this command is referred to as the "Graphics function." The name is important as it distinguishes it from conventional bit image functions.

- The graphics functions provided here maintain upward compatibility with conventional bit image processing.

Graphics type	Corresponding bit image command (*1)
NV graphics	<b>FS p, FS q</b>
Download graphics	<b>GS *, GS /</b>
Graphics	<b>GS Q 0, GS v 0</b>

(\*1) These commands are supported by some of the printer models but will not be supported by future models.

- The various graphics functions (of this command), more user-friendly than conventional bit image functions, offer the following advantages.
  - Definition of multiple items of logo mark and insignia data (with most functions).
  - Management of data using key codes.
  - Deletion of and redefinition of data per key code.
  - Color coding of image-data.
  - Definition of image-data in both raster and column formats.
  - Confirmation of available capacity in domain.
  - Continuous processing possible (without a software reset when a command has been processed).
- The following three types of graphics functions are included.
  - NV graphics [Functions 48, 51, 64, 65, 66, 67, 68, and 69]  
Stores data in non-volatile memory.  
Defined data is retained when power is turned off.  
There is a limit on the number of times that non-volatile memory can be written to.
  - Download graphics [Functions 52, 80, 81, 82, 83, 84, and 85]  
Stores data in volatile memory (RAM).  
Defined data is lost when the **ESC @** command is executed, the system is reset, or power is turned off.



- Graphics [Functions 50, 112, and 113]  
Stores data in the print buffer.  
When standard mode is selected, prints data using Function 50 and clears the print buffer.  
When page mode is selected, prints data using **FF** and **ESC FF** and clears the print buffer after **FF** is executed.

## [Notes]

- The functions of this command are determined by the (**fn**) setting. Actual command operation varies according to function.
- The NV graphics and download graphics data is managed using key codes.
  - Expressed as **kc1** and **kc2**, the key codes are used to identify data groups.
  - The key codes have a 2-byte configuration and can be specified using the full range of character codes in Hexadecimal: 20H to 7EH / in Decimal: 32 to 126.
  - The data referred to here is image data specified using **d1** through **dk** of Functions 67, 68, 83, and 84.
  - The printer automatically adds control information when it stores the data. The image data domain is used as the control information. Control information formats and data values vary according to function.
- Note that it is not possible to create definitions for both NV graphics data (this command) and NV bit image data (**FS q**). NV bit image data definitions are deleted when this command is used.
- Note that it is not possible to create definitions for both download graphics data (this command) and download bit image data (**GS \***). Download bit image data definitions are deleted when this command is used.
- With certain printers, it is not possible to create definitions for both download graphics data (this command) and download character data (**ESC &**).
  - Defined download character data is deleted when this command is used.
  - Executing **ESC &** deletes download graphics data.
- Always execute Function 50 after executing this command 112 or 113 when the standard mode is selected.
- When printing the various types of graphics data, using the **ESC U** command will ensure that the printed results are properly aligned vertically by printing in a single direction.
- Functions 65, 66, 67, or 68 write data to a non-volatile memory. Note the following items when using the function.

- Do not turn off the power or reset the printer from the interface when the relevant functions are being executed.
- The printer may be BUSY when storing data and will not receive any data. In this case, be sure not to transmit data from the host.
- Excessive use of this function may destroy the non-volatile memory. As a guideline, do not use any combination of the following commands more than 10 times per day for writing data to the non-volatile memory: **GS ( A** (part of functions), **GS ( C** (part of functions), **GS ( E** (part of functions), **GS ( L / GS 8 L** (part of functions), **GS ( M** (part of functions), **GS g 0, FS q 1, FS q.**
- The following restrictions apply when performing non-volatile memory operations (including data store and delete).
  - The paper cannot be fed by paper feed switch.
  - The real time command is not processed.
  - The ASB status will not be sent, even when the ASB function is set to enable.

[Notes for transmission process]

- Data send operations are performed using Functions 48, 51, 52, 64, and 80. When you use these functions, obey the following rules.
  - When the host PC transmits the function data, transmit the next data after receiving the corresponding data (Header ~ NULL) from the printer.
  - When operating with a serial interface, be sure to configure operation so that the host computer uses the printer only when it is READY.
  - When operating with a parallel interface, the data sent by this function (starting with Header and ending with NUL), as with other data, is first stored in the send buffer, then output in sequential order when the host computer changes to the reverse mode. Note that the send buffer capacity is 99 bytes, and any data exceeding this volume limit will be lost; therefore, when using this command, it is important to configure the operation so that the host computer's change to the reverse mode and the subsequent status send/receive process is performed quickly.
- During the interval between the sending of the data header and NUL, ASB status and the real time commands are rendered invalid.

- When communication with the printer uses XON/XOFF control with serial interface, the XOFF code may interrupt the "Header to NUL" data string.
- The information for each function can be identified to other transmission data according to specific data of the transmission data block. When the header transmitted by the printer is [hex = 37H/decimal =55], treat NUL [hex = 00H/decimal =0] as a data group and identify it according to the combination of the header and the identifier.

[Notes for ESC/POS Handshaking Protocol]

- It will be necessary to perform the ESC/POS Handshaking Protocol procedures listed below when using Functions 64 and 80.

Procedure	Host operation	Printer operation
1	This command sends Function 64.	Function 64 is initiated.
2	Data is received from printer.	Key code list is sent.
3	Response code (*1) is sent.	Procedures (*2 and *3) are performed according to response code.

(\*1) Response Code

ASCII	Hexadecimal	Decimal	Request definition
ACK	06	6	Send next data group.
NAK	15	21	Resend just-received data group.
CAN	18	24	Cancel send operation.

(\*2) Processing According to Response Code (When Send Data Remains (indicated by identification status of send data group))

<b>Response code</b>	<b>Description</b>
ACK	Initiates operation to send next data.
NAK	Resends the just-received data.
CAN	Cancels processing initiated by this command.

(\*3) Processing According to Response Code (When No More Send Data Remains (indicated by identification status of send data group))

<b>Response code</b>	<b>Description</b>
ACK, CAN	Cancels procedure initiated by this command.
NAK	Resends the just-received data.

■ When codes other than the ACK, NAK, or CAN codes are received, the CAN procedure is executed.

## Program Sample 1 (Defining and printing NV graphics data)

\* Description for image data has been omitted.

```

PRINT #1, CHR$( &H1D ); " (L"; CHR$( 76 ); CHR$( 6 ); CHR$( 48 ); CHR$( 67 ); CHR$( 48 ); ←Function 67: defining data
(raster)
PRINT #1, "G1"; ←Key code
PRINT #1, CHR$( 2 ); ←Color no.
PRINT #1, CHR$( 80 ); CHR$( 0 ); ←Horizontal size (80 dots)
PRINT #1, CHR$( 80 ); CHR$( 0 ); ←Vertical size (80 dots)
PRINT #1, CHR$( 49 ); ←Specifies Color 1
FOR i=1 to 800 ←Image data (800 bytes) for Color 1
  READ a$: d=VAL(" &H"+a$): PRINT #1, CHR$( d );
NEXT i
PRINT #1, CHR$( 50 ); ←Specifies color 2
FOR i=1 to 800 ←Image data (800 bytes) for Color 2
  READ a$: d=VAL(" &H"+a$): PRINT #1, CHR$( d );
NEXT i

PRINT #1, CHR$( &H1D ); " (L"; CHR$( 6 ); CHR$( 0 ); CHR$( 48 ); CHR$( 69 ); ←Function 69: Printing NV graphics Data
PRINT #1, "G1"; ←Key code
PRINT #1, CHR$( 2 ); CHR$( 1 ); ←Specifies size (horizontal (times 2) X vertical (times 1))
    
```

## Program Sample 2 (Printing graphics data)

\* Description for image data has been omitted.

```

PRINT #1, CHR$( &H1D ); " (L"; CHR$(250); CHR$(0); CHR$(48); CHR$(112); CHR$(48); ←Function 112: sending data
(raster)
PRINT #1, CHR$(1); CHR$(1); ←Specifies size (horizontal (times 1) × vertical (times 1))
PRINT #1, CHR$(49); ←Specifies color 1
PRINT #1, CHR$(80); CHR$(0); ←Horizontal size (80 dots)
PRINT #1, CHR$(24); CHR$(0); ←Vertical size (24 dots)
FOR i=1 to 240 ←Image data (240 bytes)
  READ a$: d=VAL("&H"+a$): PRINT #1, CHR$(d);
NEXT i

PRINT #1, CHR$( &H1D ); " (L"; CHR$(250); CHR$(0); CHR$(48); CHR$(112); CHR$(48); ←Function 112: sending data
(raster)
PRINT #1, CHR$(1); CHR$(1); ←Specifies size (horizontal (times 1) × vertical (times 1))
PRINT #1, CHR$(50); ←Specifies color 2
PRINT #1, CHR$(80); CHR$(0); ←Horizontal size (80 dots)
PRINT #1, CHR$(24); CHR$(0); ←Vertical size (24 dots)
FOR i=1 to 240 ←Image data (240 bytes)
  READ a$: d=VAL("&H"+a$): PRINT #1, CHR$(d);
NEXT i

PRINT #1, CHR$( &H1D ); " (L"; CHR$(2); CHR$(0); CHR$(48); CHR$(50); ←Function 50: printing graphics data

```

## Program Sample 3 (Sending key code list)

```
PRINT #1, CHR$( &H1D ); " (L"; CHR$(4); CHR$(0); CHR$(48); CHR$(64); CHR$(75); CHR$(67); ←Function 64:
*LOOP:
GOSUB *RECEIVE ←Receives "Header to NUL" data and stores it in ST$ (description omitted)
PRINT #1, CHR$(6); ←Sends response code
PRINT MID$(ST$,4) ←Displays received data on the monitor
IF MID$(ST$,3,1)=CHR$(65) THEN *LOOP ←Checks for presence of continuing data
```

## Program Sample 4 (Sending information on capacity available in NV graphics domain)

```
PRINT #1, CHR$( &H1D ); " (L"; CHR$(2); CHR$(0); CHR$(48); CHR$(51); ←Function 51:
GOSUB *RECEIVE ←Receives "Header to NUL" data and stores it in ST$ (description omitted)
PRINT MID$(ST$,4) ←Displays available capacity information on monitor.
```

### TM-J2000/J2100

The printer supports all functions.

NV graphics data shares the domain used by user NV memory [GS ( C] record data. The entire capacity is 384 KB.

Only "the Color 1" can be used in special ink cartridge (SJIC5) of TM-J2000.

The following printing colors are available when the SJIC3 and SJIC4 cartridge specially designed for the TM-J2100 printer, is used

Color selection	Printing color
Color 1	Black (SJIC3(K))
Color 2	Red (SJIC4(R)), blue (SJIC4(B)) and green (SJIC4(G))
Color 3	Color 1 + Color 2

Note that graphics data in raster format is processed more quickly than data in column format on this series of printers.

## TM-T90, TM-L90

The printer supports Functions 48, 50, 51, 64 to 67, 69 and 112.

The domain of the NV graphics data can be selected by using Function 5 of the **GS ( E** command. (Unit: byte)

Selectable data domain	Default
0, 64 K, 128 K, 192 K, 256 K, 320 K, 384 K	384 K

The following printing colors are available when two-color printing control is selected with **GS ( E** <Function 5>.

Color selection	Printing color	Control
Color 1	Black	Printing high energy
Color 2	Red	Printing low energy

Characters printed with Color 2 may fade, depending on the storage environment. Therefore, when the printing needs to last a long time, print with Color 1.



## TM-T88IV

The printer supports Functions 48, 50, 51, 64 to 67, 69 and 112.

The NV graphics data domain is 256 KB.

The following printing colors are available when two-color printing control is selected with **GS ( E <Function 5>**.

Color selection	Printing color	Control
Color 1	Black	Printing high energy
Color 2	Red	Printing low energy

Characters printed with Color 2 may fade, depending on the storage environment. Therefore, when the printing needs to last a long time, print with Color 1.

The NV graphic definition information can be printed in the "NV graphics print mode" by operating the panel switch when turning on the power.

## TM-T70

The printer supports Functions 48, 50, 51, 64 to 67, 69 and 112.

The NV graphics data domain is 256 KB.

The NV graphic definition information can be printed in the "NV graphics print mode" by operating the panel switch when turning on the power.

## TM-P60

The printer supports Functions 48, 50, 51, 64 to 67, 69 and 112.

NV graphics data shares the domain used by user NV memory [GS ( C ] record data. The entire capacity is 384 KB.

## GS ( L *pl* *ph* *m* *fn* <Function 48>

---

[Name] Transmit the NV graphics memory capacity.

[Format] ASCII GS ( L **pl** **ph** **m** **fn**  
 Hex 1D 28 4C 02 00 30 **fn**  
 Decimal 29 40 76 2 0 48 **fn**

[Range] (**pl** + **ph** × 256) = 2 (**pl** = 2, **ph** = 0)  
**m** = 48  
**fn** = 0, 48

[Description] Transmits the entire capacity of the NV graphics area (number of bytes in the NV graphics area).

- This function does not require ESC/POS Handshaking Protocol.

[Notes] ■ This function is used to send the following data groups, beginning with the Header and ending with NUL.

Send data	Hexadecimal	Decimal	Data length
Header	37H	55	1 byte
Identifier	30H	48	1 byte
Entire capacity <sup>(*1)</sup>	30H to 39H	48 to 57	1 to 8 bytes
NUL	00H	0	1 byte

(\*1) The entire capacity is the total byte count for that domain. The decimal value for the entire capacity is converted to text data and sent starting from the high order end.

Example:

If the entire capacity is 1200 bytes, the "1200" (expressed hexadecimally as 31H, 32H, 30H, and 30H, decimally as 49, 50, 48, and 48) is converted to 4-byte data.

- When this function is used to send the entire capacity, the entire byte capacity of the domain is sent, regardless of definitions currently entered for NV graphics data. The entire capacity referred to here includes the area used for control information.
- Note that the NV graphics function cannot be used when the value for the entire capacity is "0" (expressed hexadecimally as 30H and decimally as 48).
- See previous [Notes for transmission process] for process sending data group.

[Model-dependent variations]

**TM-T90, TM-L90**

## **TM-T90**

If you select a combination of settings that is not possible, the entire capacity of the NV graphics memory that can be in actual use will be sent instead of the memory size set by **GS ( E**.

## **TM-L90**

If you select a combination of settings that is not possible, the entire capacity of the NV graphics memory that can be in actual use will be sent instead of the memory size set by **GS ( E**.

## GS ( L pL pH m fn x y <Function 49>

---

[Name] Set the reference dot density for graphics.

[Format]

ASCII	GS (	L	<b>pL</b>	<b>pH</b>	<b>m</b>	<b>fn</b>	<b>x</b>	<b>y</b>
Hex	1D 28 4C	04	00	30	<b>fn</b>	<b>x</b>	<b>y</b>	
Decimal	29 40 76	4	0	48	<b>fn</b>	<b>x</b>	<b>y</b>	

[Range]  $(pL + pH \times 256) = 4$  (**pL** = 4, **pH** = 0)  
**m** = 48  
**fn** = 1, 49  
**x** = 50, 51  
**y** = 50 [when **x** = 50]  
**y** = 51 [when **x** = 51]

[Description] Sets the reference dot density to process the graphics data or bit image data. (dpi: dots per inch)

- [180 dpi × 180 dpi] is selected when **x** = 50 and **y** = 50
- [360 dpi × 360 dpi] is selected when **x** = 51 and **y** = 51

[Notes] ■ Note that certain settings for this function may affect the processing of the types of graphics and bit image data listed in the table below.

■ Command: **GS ( L** and **GS 8 L**

Function no.	Function name
<b>Function 67</b>	Define the NV graphics data (raster format).
<b>Function 68</b>	Define the NV graphics data (column format).
<b>Function 83</b>	Define the download graphics data (raster format).
<b>Function 84</b>	Define the download graphics data (column format).
<b>Function 112</b>	Store the graphics data in the print buffer (raster format).
<b>Function 113</b>	Store the graphics data in the print buffer (column format).

## ■ Bit image

Command	Name
<b>FS q</b>	Print NV bit image
<b>GS /</b>	Print download bit image
<b>GS Q 0</b>	Print variable vertical size bit image
<b>GS v 0</b>	Print raster bit image

[Model-dependent variations]

**TM-T90, TM-T88IV, TM-T70, TM-L90, TM-P60**

**TM-T90, TM-T88IV, TM-T70, TM-L90, TM-P60**

**The printer does not support this function.**

## **GS ( L *pL pH m fn* <Function 50 >**

---

[Name] Print the graphics data in the print buffer.

[Format]

ASCII	GS	(	L	<b>pL</b>	<b>pH</b>	<b>m</b>	<b>fn</b>
Hex	1D	28	4C	02	00	30	<b>fn</b>
Decimal	29	40	76	2	0	48	<b>fn</b>

[Range] (**pL** + **pH** × 256) = 2 (**pL** = 2, **pH** = 0)  
**m** = 48  
**fn** = 2, 50

[Description] Prints the buffered graphics data stored by the process of **GS ( L** <Function 112 or 113>.

- [Notes]
- The printer cannot print when there is no graphics data stored in the print buffer.
  - Functions 112 and 113 of this command are used to store graphics data in the print buffer.
  - This function cannot be used when the page mode is enabled.
  - Feeds the paper the required distance when printing graphics data, regardless of line feed pitch settings entered using the Set line feed command.
  - Moves print position to the left side of the print area after printing of graphics data is completed. The printer then enters the "beginning of the line" or "no data in print buffer" state.

## GS ( L *pL pH m fn* <Function 51 >

---

[Name] Transmit the remaining capacity of the NV graphics memory.

[Format]

ASCII	GS (	L	<b>pL</b>	<b>pH</b>	<b>m</b>	<b>fn</b>
Hex	1D 28	4C	02	00	30	<b>fn</b>
Decimal	29 40	76	2	0	48	<b>fn</b>

[Range] (**pL** + **pH** × 256) = 2 (**pL** = 2, **pH** = 0)  
**m** = 48  
**fn** = 3, 51

[Description] Transmits the number of bytes of remaining memory (unused area) in the NV graphics area.

- This function does not require ESC/POS Handshaking Protocol.

[Notes] ■ This function is used to send the following data groups, beginning with the Header and ending with NUL.

Send data	Hexadecimal	Decimal	Data length
Header	37H	55	1 byte
Identifier	31H	49	1 byte
Unused capacity (*1)	30H to 39H	48 to 57	1 to 8 bytes
NUL	00H	0	1 byte

(\*1) The unused capacity is the total byte count for the unused area. The decimal value for the unused capacity is converted to text data and sent starting from the high order end.

Example:

If the available capacity is 120 bytes, the "120" (expressed hexadecimally as 31H, 32H, and 30H, decimally as 49, 50, and 48) is converted to 3-byte data.

- The control information for NV graphics data is included in the capacity in use.
- See previous [Notes for transmission process] for process sending data group.
- Do not use this function in conjunction with NV bit images (**FS q**).

[Model-dependent variations] None

## GS ( L *pL* *pH* *m* *fn* <Function 52 >

---

[Name] Transmit the remaining capacity of the download graphics memory.

[Format]

ASCII	GS (	L	<b>pL</b>	<b>pH</b>	<b>m</b>	<b>fn</b>
Hex	1D 28	4C	02	00	30	<b>fn</b>
Decimal	29 40	76	2	0	48	<b>fn</b>

[Range]  $(\mathbf{pL} + \mathbf{pH} \times 256) = 2$  ( $\mathbf{pL} = 2, \mathbf{pH} = 0$ )  
**m** = 48  
**fn** = 4, 52

[Description] Transmits the number of bytes of remaining memory (unused area) in the downloaded graphics area.

- This function does not require ESC/POS Handshaking Protocol.

[Notes] ■ This function is used to send the following data groups, beginning with the Header and ending with NUL.

Send data	Hexadecimal	Decimal	Data length
Header	37H	55	1 byte
Identifier	32H	50	1 byte
Unused capacity (*1)	30H to 39H	48 to 57	1 to 8 bytes
NUL	00H	0	1 byte

(\*1) The unused capacity is the total byte count for the unused area. The decimal value for the unused capacity is converted to text data and sent starting from the high order end.

Example:

If the available capacity is 120 bytes, the "120" (expressed hexadecimally as 31H, 32H, and 30H, decimally as 49, 50, and 48) is converted to 3-byte data.

- The control information for download graphics data is included in the capacity in use.
- Do not use this function in conjunction with download bit images (**GS** \*) and download characters (**ESC &**).
- See previous [Notes for transmission process] for process sending data group.



# C O N F I D E N T I A L

[Model-dependent variations]

**TM-T90, TM-T88IV, TM-T70, TM-L90, TM-P60**

**TM-T90, TM-T88IV, TM-T70, TM-L90, TM-P60**

**The printer does not support this function.**

## **GS ( L *pL* *pH* *m* *fn* *d1* *d2* <Function 64 >**

---

[Name] Transmit the key code list for defined NV graphics.

[Format] ASCII GS ( L **pL** **pH** **m** **fn** **d1** **d2**  
 Hex 1D 28 4C 04 00 30 40 4B 43  
 Decimal 29 40 76 4 0 48 64 75 67

[Range] (**pL** + **pH** × 256) = 4 (**pL** = 4, **pH** = 0)  
**m** = 48  
**fn** = 64  
**d1** = 75  
**d2** = 67

[Description] Transmits the defined NV graphics key code list.

- This function does require ESC/POS Handshaking Protocol.

[Notes] ■ When key codes are present, the data shown below (beginning with Header and ending with NUL) is sent.

Send data	Hexadecimal	Decimal	Data length
Header	37H	55	1 byte
Identifier	72H	114	1 byte
Identification status (*1) (*2)	40H or 41H	64 or 64	1 byte
Data (*3)	30H to 39H	48 to 57	2 to 80 bytes
NUL	00H	0	1 byte

(\*1) When the number of NV graphics data groups exceeds 40, the groups are divided into blocks:

- When unsent data is present, the Identification status byte (byte 3) is set to hexadecimal value 41H and decimal value 65.
- When unsent data is not present, the Identification status byte (byte 3) is set to hexadecimal value 40H and decimal value 64.

(\*2) If the number of NV graphics data groups is 40 or less, they are sent in a single batch, with the Identification status byte (byte 3) set to hexadecimal value 40H and decimal value 64.

(\*3) The data groups are arranged according to the key codes.

- When no key codes are present, the data shown below (beginning with Header and ending with NUL) is sent.

Send data	Hexadecimal	Decimal	Data length
Header	37H	55	1 byte
Identifier	72H	114	1 byte
Identification status	40H	64	1 byte
NUL	00H	0	1 byte

- Do not use this function in conjunction with NV bit images (**FS q**).
- See previous [Notes for transmission process] for process sending data group.
- See previous [Notes for ESC/POS Handshaking Protocol] for ESC/POS Handshaking Protocol.

## **GS ( L *pL pH m fn d1 d2 d3* <Function 65>**

---

[Name]	Delete all NV graphics data.																																	
[Format]	<table> <tr> <td>ASCII</td> <td>GS</td> <td>(</td> <td>L</td> <td><b>pL</b></td> <td><b>pH</b></td> <td><b>m</b></td> <td><b>fn</b></td> <td><b>d1</b></td> <td><b>d2</b></td> <td><b>d3</b></td> </tr> <tr> <td>Hex</td> <td>1D</td> <td>28</td> <td>4C</td> <td>05</td> <td>00</td> <td>30</td> <td>41</td> <td>43</td> <td>4C</td> <td>52</td> </tr> <tr> <td>Decimal</td> <td>29</td> <td>40</td> <td>76</td> <td>5</td> <td>0</td> <td>48</td> <td>65</td> <td>67</td> <td>76</td> <td>82</td> </tr> </table>	ASCII	GS	(	L	<b>pL</b>	<b>pH</b>	<b>m</b>	<b>fn</b>	<b>d1</b>	<b>d2</b>	<b>d3</b>	Hex	1D	28	4C	05	00	30	41	43	4C	52	Decimal	29	40	76	5	0	48	65	67	76	82
ASCII	GS	(	L	<b>pL</b>	<b>pH</b>	<b>m</b>	<b>fn</b>	<b>d1</b>	<b>d2</b>	<b>d3</b>																								
Hex	1D	28	4C	05	00	30	41	43	4C	52																								
Decimal	29	40	76	5	0	48	65	67	76	82																								
[Range]	<p><b>(pL + pH × 256) = 5 (pL = 5, pH = 0)</b>  <b>m = 48</b>  <b>fn = 65</b>  <b>d1 = 67</b>  <b>d2 = 76</b>  <b>d3 = 82</b></p>																																	
[Description]	<p>Deletes all NV graphics data that has been defined using Functions 67 or 68.</p> <ul style="list-style-type: none"> <li>Deleted areas are designated "Unused areas."</li> <li>All key codes are designated as undefined.</li> </ul>																																	
[Notes]	<ul style="list-style-type: none"> <li>■ Use this function at the beginning of the line when the standard mode is selected.</li> <li>■ This function is incompatible with macros, so be sure to avoid including it when defining macros.</li> <li>■ When NV graphics data is being shared by multiple applications, executing this function will delete all data being used by all applications. Caution is required when using this function.</li> </ul>																																	

## **GS ( L *pL* *pH* *m* *fn* *kc1* *kc2* <Function 66 >**

---

[Name] Delete the specified NV graphics data.

[Format]

ASCII	GS (	L	<b>pL</b>	<b>pH</b>	<b>m</b>	<b>fn</b>	<b>kc1</b>	<b>kc2</b>
Hex	1D 28 4C	04 00 30 42	<b>kc1</b>	<b>kc2</b>				
Decimal	29 40 76	4 0 48 66	<b>kc1</b>	<b>kc2</b>				

[Range]

**(pL + pH × 256) = 4 (pL = 4, pH = 0)**  
**m = 48**  
**fn = 66**  
**32 ≤ kc1 ≤ 126**  
**32 ≤ kc2 ≤ 126**

[Description] Deletes the NV graphics data defined by the key codes (**kc1** and **kc2**).

- Deleted areas are designated "Unused areas."
- Deleted key codes are designated as undefined.

[Notes]

- Use this function at the beginning of the line when the standard mode is selected.
- This function is incompatible with macros, so be sure to avoid including it when defining macros.

**GS ( L pL pH m fn a kc1 kc2 b xL xH yL yH [c d1...dk]1...[c d1...dk]b** <Function 67 >

**GS 8 L p1 p2 p3 p4 m fn a kc1 kc2 b xL xH yL yH [c d1...dk]1...[c d1...dk]b**

[Name]	Define the NV graphics data (raster format).																		
[Format]	ASCII	GS	(	L	<b>pL</b>	<b>pH</b>	<b>m</b>	<b>fn</b>	<b>a</b>	<b>kc1</b>	<b>kc2</b>	<b>b</b>	<b>xL</b>	<b>xH</b>	<b>yL</b>	<b>yH</b>	<b>[c d1...dk]1...[c d1...dk]b</b>		
	Hex	1D	28	4C	<b>pL</b>	<b>pH</b>	30	43	30	<b>kc1</b>	<b>kc2</b>	<b>b</b>	<b>xL</b>	<b>xH</b>	<b>yL</b>	<b>yH</b>	<b>[c d1...dk]1...[c d1...dk]b</b>		
	Decimal	29	40	76	<b>pL</b>	<b>pH</b>	48	67	48	<b>kc1</b>	<b>kc2</b>	<b>b</b>	<b>xL</b>	<b>xH</b>	<b>yL</b>	<b>yH</b>	<b>[c d1...dk]1...[c d1...dk]b</b>		
	ASCII	GS	8	L	<b>p1</b>	<b>p2</b>	<b>p3</b>	<b>p4</b>	<b>m</b>	<b>fn</b>	<b>a</b>	<b>kc1</b>	<b>kc2</b>	<b>b</b>	<b>xL</b>	<b>xH</b>	<b>yL</b>	<b>yH</b>	<b>[c d1...dk]1...[c d1...dk]b</b>
	Hex	1D	38	4C	<b>p1</b>	<b>p2</b>	<b>p3</b>	<b>p4</b>	30	43	30	<b>kc1</b>	<b>kc2</b>	<b>b</b>	<b>xL</b>	<b>xH</b>	<b>yL</b>	<b>yH</b>	<b>[c d1...dk]1...[c d1...dk]b</b>
	Decimal	29	56	76	<b>p1</b>	<b>p2</b>	<b>p3</b>	<b>p4</b>	48	67	48	<b>kc1</b>	<b>kc2</b>	<b>b</b>	<b>xL</b>	<b>xH</b>	<b>yL</b>	<b>yH</b>	<b>[c d1...dk]1...[c d1...dk]b</b>
[Range]	$12 \leq (\mathbf{pL} + \mathbf{pH} \times 256) \leq 65535$ $(0 \leq \mathbf{pL} \leq 255, 0 \leq \mathbf{pH} \leq 255)$ [When using <b>GS 8 L</b> : $12 \leq (\mathbf{p1} + \mathbf{p2} \times 256 + \mathbf{p3} \times 65536 + \mathbf{p4} \times 16777216) \leq 4294967295$ $\mathbf{m} = 48, \mathbf{fn} = 67, \mathbf{a} = 48$ $32 \leq \mathbf{kc1} \leq 126$ $32 \leq \mathbf{kc2} \leq 126$ $\mathbf{b} = 1, 2$ $1 \leq (\mathbf{xL} + \mathbf{xH} \times 256) \leq 8192$ ( $0 \leq \mathbf{xL} \leq 255, 0 \leq \mathbf{xH} \leq 32$ ) $1 \leq (\mathbf{yL} + \mathbf{yH} \times 256) \leq 2304$ ( $0 \leq \mathbf{yL} \leq 255, 0 \leq \mathbf{yH} \leq 9$ ) $\mathbf{c} = 49, 50$ (when the recommended two-color paper is used) $\mathbf{c} = 49$ (when the recommended monochrome paper is used) $0 \leq \mathbf{d} \leq 255$ $\mathbf{k} = (\text{int}((\mathbf{xL} + \mathbf{xH} \times 256) + 7)/8) \times (\mathbf{yL} + \mathbf{yH} \times 256)$ <b>TM-J2000/J2100:</b> $\mathbf{b} = 1, 2$ (TM-J2100 [two-color printing model]: when $\mathbf{c} = 49, 50$ ) $\mathbf{b} = 1$ (TM-J2100 [two-color printing model]: when $\mathbf{c} = 51$ or TM-J2000 [single-color printing model]) $1 \leq (\mathbf{xL} + \mathbf{xH} \times 256) \leq 8192$ ( $0 \leq \mathbf{xL} \leq 255, 0 \leq \mathbf{xH} \leq 32$ ) $1 \leq (\mathbf{yL} + \mathbf{yH} \times 256) \leq 2304$ ( $0 \leq \mathbf{yL} \leq 255, 0 \leq \mathbf{yH} \leq 9$ ) $49 \leq \mathbf{c} \leq 51$ (TM-J2100 [two-color printing model]) $\mathbf{c} = 49$ (TM-J2000 [single-color printing model])																		

- TM-T90, TM-L90:** **b = 1** (when the recommended monochrome paper is used)  
**b = 1, 2** (when the recommended two-color paper is used)  
 $1 \leq (x_L + x_H \times 256) \leq 8192$  ( $0 \leq x_L \leq 255, 0 \leq x_H \leq 32$ )  
 $1 \leq (y_L + y_H \times 256) \leq 2304$  ( $0 \leq y_L \leq 255, 0 \leq y_H \leq 9$ )  
**c = 49** (when the recommended monochrome paper is used)  
**c = 49, 50** (when the recommended two-color paper is used)
- TM-T88IV:** **b = 1** (when single-color printing control is selected)  
**b = 1, 2** (when two-color printing control is selected)  
 $1 \leq (x_L + x_H \times 256) \leq 8192$  ( $0 \leq x_L \leq 255, 0 \leq x_H \leq 32$ )  
 $1 \leq (y_L + y_H \times 256) \leq 2304$  ( $0 \leq y_L \leq 255, 0 \leq y_H \leq 9$ )  
**c = 49** (when single-color printing control is selected)  
**c = 49, 50** (when two-color printing control is selected)
- TM-T70:** **b = 1**  
 $1 \leq (x_L + x_H \times 256) \leq 8192$  ( $0 \leq x_L \leq 255, 0 \leq x_H \leq 32$ )  
 $1 \leq (y_L + y_H \times 256) \leq 2304$  ( $0 \leq y_L \leq 255, 0 \leq y_H \leq 9$ )  
**c = 49**
- TM-P60:** **b = 1**  
 $1 \leq (x_L + x_H \times 256) \leq 1024$  ( $0 \leq x_L \leq 255, 0 \leq x_H \leq 4$ )  
 $1 \leq (y_L + y_H \times 256) \leq 1200$  ( $0 \leq y_L \leq 255, 0 \leq y_H \leq 4$ )  
**c = 49**

[Description]

Defines the NV graphics data (raster format) as a record specified by the key codes (**kc1** and **kc2**) in the NV graphics area.

- **b** specifies the number of colors for the defined data.
- **xL** and **xH** specify the number of dots in the horizontal direction as  $(x_L + x_H \times 256)$ .
- **yL** and **yH** specify the number of dots in the vertical direction as  $(y_L + y_H \times 256)$ .
- **c** specifies the color of the defined data.

<b>c</b>	<b>Color specifications</b>
49	Color 1
50	Color 2
51	Colors 3

[Notes]

- **d** specifies the defined data (raster format).
- **k** indicates the number of the definition data. **k** is an explanation parameter; therefore it does not need to be transmitted.
- In cases where the specified key code already exists in memory, it will be necessary to overwrite the data.
- NV graphics indicate image data groups defined in the printer's internal non-volatile memory. Data definitions for NV graphics data created using this command are valid until redefined by this function or <Function 68>.
- The functions used to define NV graphics data are this function and Function 68. Even with printer models that support both, it is recommended that only one of the functions be used for data definition tasks.
  - The two functions differ only in that one function (this function) defines data in raster format, while the other (Function 68) defines data in column format. The domains and control information are identical.
  - In cases where the key code specified by this function coincides with a key code being used by Function 68, a new data definition is created.
- Use this function at the beginning of the line when the standard mode is selected.
- This function is incompatible with macros, so make sure to avoid including it when defining macros.
- In cases where there is insufficient capacity available for storing NV graphics data, this function cannot be used. Use Function 51 to confirm the available capacity in the NV graphics data area.
- One option is to delete items of NV graphics data that were previously defined to the same key code.
- The data for byte **k** of **d1 ... dk** is processed as a single item of defined NV graphics data. The defined data (**d**) specifies "1" for bits corresponding to dots that will be printed and "0" for bits corresponding to dots that will not be printed.
- NV graphics data is defined using the dot density set by Function 49.
- Specify single data groups [**c d1 ... dk**] when monochrome is selected (**b** = 1) as the color.
- Specify **b** number of data groups [**c d1 ... dk**] when multiple colors are selected (**b** ≠ 1). It is also important to specify different colors in units of data groups when specifying color (**c**).
- NV graphics data is printed using Function 69.



- Note that it is not possible to create definitions for both NV graphics data (this command) and NV bit image data (**FS q**). NV bit image data definitions are deleted when this command is used.
- The relationship between NV graphics data (raster format) and print results is shown in the table below.

<b>d1</b>	<b>d2</b>	...	<b>dx</b>
<b>dx+1</b>	<b>dx+2</b>	...	<b>dx+2</b>
:	:	...	:
...	<b>dk-2</b>	<b>dk-1</b>	<b>dk</b>
MSB LSB	MSB LSB	MSB LSB	MSB LSB

**X** = (**xL** + **xH** × 256)

[Model-dependent variations]

**TM-J2000/J2100**, **TM-T90**, **TM-L90**, **TM-T88IV**, **TM-T70**, **TM-P60**

## **TM-J2000/J2100**

This printer is equipped with a print head configured in column format, which makes it faster to define data using Function 68 (column format) than with this function.

The [data value (**k**) + control information data value (32 bytes)] area of the NV graphics data domain is used when this function is executed.

## **TM-T90, TM-L90**

For specifying paper (2-color/single-color), see Functions 5 of **GS ( E**.

The [data value (**k**) + control information data value (24 bytes)] area of the NV graphics data domain is used when this function is executed.

## TM-T88IV

Refer to **GS ( E <Function 5>** for specifying printing control (single-color/two-color).

The [data value (**k**) + control information data value (24 bytes)] area of the NV graphics data domain is used when this function is executed.

In order to shorten the execution time of this function, aim to use no more than 50 types for the number of NV graphics registered. The maximum execution time when less than 50 types for the number registered is 60 seconds. The execution time when 100 types for the number registered may be as much as 120 seconds.

## TM-T70

The [data value (**k**) + control information data value (24 bytes)] area of the NV graphics data domain is used when this function is executed.

In order to shorten the execution time of this function, aim to use no more than 50 types for the number of NV graphics registered. The maximum execution time when less than 50 types for the number registered is 60 seconds. The execution time when 100 types for the number registered may be as much as 120 seconds.

## TM-P60

The [data value (**k**) + control information data value (see the table below)] area of the NV graphics data domain is used when this function is executed.

Condition	Control information data value
If data value ( <b>k</b> ) is odd number	32 bytes
If data value ( <b>k</b> ) is even number	33 bytes

# CONFIDENTIAL

**GS ( L p<sub>L</sub> p<sub>H</sub> m fn a kc1 kc2 b x<sub>L</sub> x<sub>H</sub> y<sub>L</sub> y<sub>H</sub> [c d1...dk]1...[c d1...dk]b** <Function 68>

**GS 8 L p1 p2 p3 p4 m fn a kc1 kc2 b x<sub>L</sub> x<sub>H</sub> y<sub>L</sub> y<sub>H</sub> [c d1...dk]1...[c d1...dk]b**

[Name] Define the NV graphics data (column format).

[Format]	ASCII	GS	(	L	<b>p<sub>L</sub></b>	<b>p<sub>H</sub></b>	<b>m</b>	<b>fn</b>	<b>a</b>	<b>kc1</b>	<b>kc2</b>	<b>b</b>	<b>x<sub>L</sub></b>	<b>x<sub>H</sub></b>	<b>y<sub>L</sub></b>	<b>y<sub>H</sub></b>	<b>[c d1...dk]1...[c d1...dk]b</b>		
	Hex	1D	28	4C	<b>p<sub>L</sub></b>	<b>p<sub>H</sub></b>	30	44	30	<b>kc1</b>	<b>kc2</b>	<b>b</b>	<b>x<sub>L</sub></b>	<b>x<sub>H</sub></b>	<b>y<sub>L</sub></b>	<b>y<sub>H</sub></b>	<b>[c d1...dk]1...[c d1...dk]b</b>		
	Decimal	29	40	76	<b>p<sub>L</sub></b>	<b>p<sub>H</sub></b>	48	68	48	<b>kc1</b>	<b>kc2</b>	<b>b</b>	<b>x<sub>L</sub></b>	<b>x<sub>H</sub></b>	<b>y<sub>L</sub></b>	<b>y<sub>H</sub></b>	<b>[c d1...dk]1...[c d1...dk]b</b>		
	ASCII	GS	8	L	<b>p1</b>	<b>p2</b>	<b>p3</b>	<b>p4</b>	<b>m</b>	<b>fn</b>	<b>a</b>	<b>kc1</b>	<b>kc2</b>	<b>b</b>	<b>x<sub>L</sub></b>	<b>x<sub>H</sub></b>	<b>y<sub>L</sub></b>	<b>y<sub>H</sub></b>	<b>[c d1...dk]1...[c d1...dk]b</b>
	Hex	1D	38	4C	<b>p1</b>	<b>p2</b>	<b>p3</b>	<b>p4</b>	30	44	30	<b>kc1</b>	<b>kc2</b>	<b>b</b>	<b>x<sub>L</sub></b>	<b>x<sub>H</sub></b>	<b>y<sub>L</sub></b>	<b>y<sub>H</sub></b>	<b>[c d1...dk]1...[c d1...dk]b</b>
	Decimal	29	56	76	<b>p1</b>	<b>p2</b>	<b>p3</b>	<b>p4</b>	48	68	48	<b>kc1</b>	<b>kc2</b>	<b>b</b>	<b>x<sub>L</sub></b>	<b>x<sub>H</sub></b>	<b>y<sub>L</sub></b>	<b>y<sub>H</sub></b>	<b>[c d1...dk]1...[c d1...dk]b</b>

[Range]  $12 \leq (\mathbf{p}_L + \mathbf{p}_H \times 256) \leq 65535$  ( $0 \leq \mathbf{p}_L \leq 255$ ,  $0 \leq \mathbf{p}_H \leq 255$ )

[When using **GS 8 L**:  $12 \leq (\mathbf{p}_1 + \mathbf{p}_2 \times 256 + \mathbf{p}_3 \times 65536 + \mathbf{p}_4 \times 16777216) \leq 4294967295$ ]

**m** = 48, **fn** = 68, **a** = 48

$32 \leq \mathbf{kc1} \leq 126$

$32 \leq \mathbf{kc2} \leq 126$

$0 \leq \mathbf{d} \leq 255$

$\mathbf{k} = (\mathbf{x}_L + \mathbf{x}_H \times 256) \times (\text{int}((\mathbf{y}_L + \mathbf{y}_H \times 256) + 7)/8)$

**TM-J2000/J2100:** **b** = 1, 2 (TM-J2100 [two-color printing model]: when **c** = 49, 50)

**b** = 1 (TM-J2100 [two-color printing model]: when **c** = 51 or  
TM-J2000 [single-color printing model])

$1 \leq (\mathbf{x}_L + \mathbf{x}_H \times 256) \leq 8192$  ( $0 \leq \mathbf{x}_L \leq 255$ ,  $0 \leq \mathbf{x}_H \leq 32$ )

$1 \leq (\mathbf{y}_L + \mathbf{y}_H \times 256) \leq 2304$  ( $0 \leq \mathbf{y}_L \leq 255$ ,  $0 \leq \mathbf{y}_H \leq 9$ )

$49 \leq \mathbf{c} \leq 51$  (TM-J2100 [two-color printing model])

**c** = 49 (TM-J2000 [single-color printing model])

# CONFIDENTIAL

[Description]

Defines the NV graphics data (column format) as a record specified by the key codes (**kc1** and **kc2**) in the NV graphics area.

- **b** specifies the number of colors for the defined data.
- **XL** and **xH** specify the number of dots in the horizontal direction as  $(\mathbf{xL} + \mathbf{xH} \times 256)$ .
- **yL** and **yH** specify the number of dots in the vertical direction as  $(\mathbf{yL} + \mathbf{yH} \times 256)$ .
- **c** specifies the color of the defined data.

<b>c</b>	<b>Color specification</b>
49	Color 1
50	Color 2
51	Color 3

- **d** specifies the defined data (column format).
- **k** indicates the number of the definition data. **k** is an explanation parameter; therefore it does not need to be transmitted.

■ In cases where the specified key code already exists in memory, it will be necessary to overwrite the data.

[Notes]

- NV graphics indicate image data groups defined in the printer's internal non-volatile memory. Data definitions for NV graphics data created using this command are valid until redefined by this function or function 67.
- The functions used to define NV graphics data are this function and Function 67. Even with printer models that support both, it is recommended that only one of the functions be used for data definition tasks.
  - The two functions differ only in that one function (this function) defines data in raster format, while the other (Function 67) defines data in column format. The domains and control information are identical.
  - In cases where the key code specified by this function coincides with a key code being used by Function 67, a new data definition is created.
- Use this function at the beginning of the line when the standard mode is selected.
- This function is incompatible with macros, so make sure to avoid including it when defining macros.

- In cases where there is insufficient capacity available for storing NV graphics data, this function cannot be used. Use Function 51 to confirm the available capacity in the NV graphics data area.
- One option is to delete items of NV graphics data that were previously defined to the same key code.
- The data for byte **k** of **d1 ... dk** is processed as a single item of defined NV graphics data. The defined data (**d**) specifies "1" for bits corresponding to dots that will be printed and "0" for bits corresponding to dots that will not be printed.
- NV graphics data is defined using the dot density set by Function 49.
- Specify single data groups [**c d1 ... dk**] when monochrome is selected (**b** = 1) as the color.
- Specify **b** number of data groups [**c d1 ... dk**] when multiple colors are selected (**b** ≠ 1). It is also important to specify different colors in units of data groups when specifying color (**c**).
- NV graphics data is printed using Function 69.
- Note that it is not possible to create definitions for both NV graphics data (this command) and NV bit image data (**FS q**). NV bit image data definitions are deleted when this command is used.
- The relationship between NV graphics data (column format) and print results is shown in the table below.

<b>d1</b>	<b>dv+1</b>	...	:	MSB LSB
<b>d2</b>	<b>dv+2</b>	...	<b>dk-2</b>	MSB LSB
:	:	...	<b>dk-1</b>	MSB LSB
<b>dv</b>	<b>dvx2</b>	...	<b>dk</b>	MSB LSB

$$Y = (y_L + y_H \times 256)$$

[Model-dependent variations]

**TM-J2000/J2100**, **TM-T90**, **TM-T88IV**, **TM-T70**, **TM-L90**, **TM-P60**

## **TM-J2000/J2100**

**This printer is equipped with a print head configured in column format, which makes it faster to define data using this function than with Function 67 (raster format).**

# C O N F I D E N T I A L

The [data value (k) + control information data value (32 bytes)] area of the NV graphics data domain is used when this function is executed.

**TM-T90, TM-T88IV, TM-T70, TM-L90, TM-P60**

**The printer does not support this function.**

## GS ( L *pL pH m fn kc1 kc2 x y* <Function 69>

---

[Name]	Print the specified NV graphics data.										
[Format]	ASCII	GS (	L	<b>pL</b>	<b>pH</b>	<b>m</b>	<b>fn</b>	<b>kc1</b>	<b>kc2</b>	<b>x</b>	<b>y</b>
	Hex	1D 28	4C	06	00	30	45	<b>kc1</b>	<b>kc2</b>	<b>x</b>	<b>y</b>
	Decimal	29 40	76	6	0	48	69	<b>kc1</b>	<b>kc2</b>	<b>x</b>	<b>y</b>
[Range]	$(\mathbf{pL} + \mathbf{pH} \times 256) = 6$ $(\mathbf{pL} = 6, \mathbf{pH} = 0)$ <b>m</b> = 48 <b>fn</b> = 69 $32 \leq \mathbf{kc1} \leq 126$ $32 \leq \mathbf{kc2} \leq 126$ <b>TM-J2000/J2100, TM-T90, TM-T88IV, TM-T70, TM-L90, TM-P60</b> : <b>x</b> = 1, 2, <b>y</b> = 1, 2										
[Description]	Prints the NV graphics data defined by the key codes ( <b>kc1</b> and <b>kc2</b> ). <ul style="list-style-type: none"> <li>Users have the option of specifying horizontal (times <b>x</b>) × vertical (times <b>y</b>) size settings for the selected data.</li> </ul>										
[Notes]	<ul style="list-style-type: none"> <li>■ This function is used to print NV graphics data defined using Functions 67 and 68 of this command.</li> <li>■ The printer only prints when NV graphics data corresponding to the specified key code is present.</li> <li>■ Use this function when the printer enters the “beginning of the line” or “no data in print buffer” state during standard mode.</li> <li>■ Note that during page mode, printing operations will not be performed simply because image data has been stored to the print buffer.</li> <li>■ NV graphics data that exceeds the print area for one line will not be printed.</li> <li>■ The scales for width and height of graphics are specified by (<b>x</b>, <b>y</b>). Therefore, in page mode with 90° or 270° clockwise-rotated graphics, the printer applies print area and dot density from [<b>x</b>: direction of paper feed, <b>y</b>: perpendicular to direction of paper feed].</li> <li>■ Settings for text effect (bold, underline, orientation, etc. except for upside-down) and font size do not affect the printing of the NV graphics data.</li> <li>■ Feeds the paper the required distance when printing graphics data, regardless of line feed pitch settings entered using the Set line feed command.</li> </ul>										

- Moves print position to the left side of the print area after printing of graphics data is completed. The printer then enters the “beginning of the line” or “no data in print buffer” state.
- When printing NV graphic files, use **ESC U** to specify unidirectional print for vertical alignment of printed text.

[Model-dependent variations]

**TM-J2000/J2100**, **TM-T90**, **TM-T88IV**, **TM-T70**, **TM-L90**, **TM-P60**

## TM-J2000/J2100

The dot density and the maximum print area are described in the next tables (dpi: number of dots per 25.4 mm).

[Dot density] and [maximum print area (dot)] indicate the value that specifies in the [basic dot density = 180 dpi]. For [basic dot density = 360 dpi], the value becomes twice for each.

“Vertical” is in the direction of paper feeding and “horizontal” is perpendicular (at right angles) to the direction of paper feeding.

The maximum print area in the vertical direction is information used when graphics are printed with the page mode selected (for the starting position specified with **ESC T** is “Upper right” or “Lower left”). In this case, graphics that are rotated by 90 degrees or 270 degrees are printed.

See Function 5 of **GS ( E** for specifying the paper width.

<TM-J2000 (single-color printing model)>

Scaling	Vertical					Horizontal				
	Dot density	Maximum print area (dot)				Dot density	Maximum print area (dot)			
		Paper width 82.5 mm	Paper width 26 mm	Paper width 69.5 mm	Paper width 57.5 mm		Paper width 82.5 mm	Paper width 76 mm	Paper width 69.5 mm	Paper width 57.5 mm
× 1	180 dpi	512	480	432	360	180 dpi	832	888	984	1184
× 2	90 dpi	256	240	216	180	90 dpi	416	444	492	592



# CONFIDENTIAL

<TM-J2100 (two-color printing model)>

Scaling	Vertical					Horizontal				
	Dot density	Maximum print area (dot)				Dot density	Maximum print area (dot)			
		Paper width 82.5 mm	Paper width 26 mm	Paper width 69.5 mm	Paper width 57.5 mm		Paper width 82.5 mm	Paper width 76 mm	Paper width 69.5 mm	Paper width 57.5 mm
× 1	180 dpi	512	480	432	360	180 dpi	640	680	760	912
× 2	90 dpi	256	240	216	180	90 dpi	320	340	380	456

## TM-T88IV

The dot density and the maximum print area are described in the next tables (dpi: number of dots per 25.4 mm).

“Vertical” is in the direction of paper feeding and “horizontal” is perpendicular (at right angles) to the direction of paper feeding.

The maximum print area in the vertical direction is information used when graphics are printed with the page mode selected (for the starting position specified with **ESC T** is “Upper right” or “Lower left”). In this case, graphics rotated by 90 degrees or 270 degrees are printed.

Scaling	Vertical			Horizontal		
	Dot density	Maximum print area (dot)		Dot density	Maximum print area (dot)	
		Paper width 80 mm	Paper width 58 mm		Single-color printing control	Two-color printing control
× 1	180 dpi	512	360	180 dpi	1662	831
× 2	90dpi	256	180	90 dpi	831	415

# CONFIDENTIAL

## TM-T70

The dot density and the maximum print area are described in the next tables (dpi: number of dots per 25.4 mm).

“Vertical” is in the direction of paper feeding and “horizontal” is perpendicular (at right angles) to the direction of paper feeding.

The maximum print area in the vertical direction is information used when graphics are printed with the page mode selected (for the starting position specified with **ESC T** is “Upper right” or “Lower left”). In this case, graphics rotated by 90 degrees or 270 degrees are printed.

Scaling	Vertical				Horizontal		
	Dot density		Maximum print area (dot)		Dot density		Maximum print area (dot)
	Other than Japanese model	Japanese model	Other than Japanese model	Japanese model	Other than Japanese model	Japanese model	
× 1	180 dpi	203 dpi	512	416	180 dpi	203 dpi	1662
× 2	90 dpi	203/2 dpi	256	208	90 dpi	203/2 dpi	831

## TM-T90

The dot density and the maximum print area are described in the next tables (dpi: number of dots per 25.4 mm).

“Vertical” is in the direction of paper feeding and “horizontal” is perpendicular (at right angles) to the direction of paper feeding.

The maximum print area in the vertical direction is information used when graphics are printed with the page mode selected (for the starting position specified with **ESC T** is “Upper right” or “Lower left”). In this case, graphics rotated by 90 degrees or 270 degrees are printed.

See Function 5 of **GS ( E** for the paper width.

# CONFIDENTIAL

## <Other than Japanese model>

Scaling	Vertical				Horizontal	
	Dot density	Maximum print area (dot)			Dot density	Maximum print area (dot)
		Paper width 80 mm	Paper width 60 mm	Paper width 58 mm		
× 1	180 dpi	512	384	360	180 dpi	831
× 2	90dpi	256	192	180	90 dpi	415

## <Japanese model>

Scaling	Vertical			Horizontal	
	Dot density	Maximum print area (dot)		Dot density	Maximum print area (dot)
		Paper width 80 mm	Paper width 60 / 58 mm		
× 1	203 dpi	576	420	203 dpi	738
× 2	203/2 dpi	288	210	203/2 dpi	369

## TM-L90

The dot density and the maximum print area are described in the next tables (dpi: number of dots per 25.4 mm).

“Vertical” is in the direction of paper feeding and “horizontal” is perpendicular (at right angles) to the direction of paper feeding.

The maximum print area in the vertical direction is information used when graphics are printed with the page mode selected (for the starting position specified with **ESC T** is “Upper right” or “Lower left”). In this case, graphics rotated by 90 degrees or 270 degrees are printed.

See Function 5 of **GS** ( **E** for the paper width.

# CONFIDENTIAL

See Function 49 of **GS** ( **E** for the origin of layout (paper layout is not used / top of black mark / bottom of label)).

Scaling	Horizontal			Vertical	
	Dot density	Maximum print area (dot)(*1)		Dot density	Maximum print area (dot)
		When paper layout is not used or top of black mark is selected	When the bottom of label is selected		
× 1	203 dpi	256 to 576	224 to 560	203 dpi	738
× 2	203/2 dpi	128 to 288	112 to 280	203/2 dpi	369

(\*1) The maximum print area in the horizontal direction is defined by the paper width.

A horizontal maximum print area is decided according to the width of the paper.

	Paper width	When (x = 1) is specified.	When (x = 2) is specified.
When paper layout is not used or top of black mark is selected	80 to 78 mm	576 dot	288 dot
	77 to 38 mm	$(256 + (\text{paper width} - 38) \times 8)$ dot	$(256 + (\text{paper width} - 38) \times 8 / 2)$ dot
When the bottom of label is selected	80 mm	560 dot	280 dot
	79 to 38 mm	$(224 + (\text{paper width} - 38) \times 8)$ dot	$(224 + (\text{paper width} - 38) \times 8 / 2)$ dot

## TM-P60

The dot density and the maximum print area are described in the next tables (dpi: number of dots per 25.4 mm).

“Vertical” is in the direction of paper feeding and “horizontal” is perpendicular (at right angles) to the direction of paper feeding.

The maximum print area in the vertical direction is information used when graphics are printed with the page mode selected (for the starting position specified with **ESC T** is “Upper right” or “Lower left”). In this case, graphics rotated by 90 degrees or 270 degrees are printed.

# CONFIDENTIAL

See Function 5 of GS ( E for the paper width.

Scaling	Horizontal			Vertical	
	Dot density	Maximum print area (dot)		Dot density	Maximum print area (dot)
		Paper width 58 mm	Paper width 60 mm		
× 1	203 dpi	420	432	203 dpi	1200
× 2	203/2 dpi	210	216	203/2 dpi	600

## GS ( L *pL* *pH* *m* *fn* *d1* *d2* <Function 80 >

---

[Name] Transmit the key code list for defined download graphics.

[Format]

ASCII	GS (	L	<b>pL</b>	<b>pH</b>	<b>m</b>	<b>fn</b>	<b>d1</b>	<b>d2</b>
Hex	1D 28	4C	04	00	30	50	4B	43
Decimal	29 40	76	4	0	48	80	75	67

[Range] (**pL** + **pH** × 256) = 4 (**pL** = 4, **pH** = 0)  
**m** = 48  
**fn** = 80  
**d1** = 75  
**d2** = 67

[Description] Transmits the defined downloaded graphics key code list.

- This function does require ESC/POS Handshaking Protocol.

[Notes] ■ When key codes are present, the data shown below (beginning with Header and ending with NUL) is sent.

Send data	Hexadecimal	Decimal	Data length
Header	37H	55	1 byte
Identifier	73H	115	1 byte
Identification status (*1) (*2)	40H or 41H	64 or 64	1 byte
Data (*3)	30H to 39H	48 to 57	2 to 80 bytes
NUL	00H	0	1 byte

(\*1) When the number of downloaded graphics data groups exceeds 40, the groups are divided into blocks:

- When unsent data is present, the Identification status byte (byte 3) is set to hexadecimal value 41H and decimal value 65.
- When unsent data is not present, the Identification status byte (byte 3) is set to hexadecimal value 40H and decimal value 64.

(\*2) If the number of downloaded graphics data groups is 40 or less, they are sent in a single batch, with the Identification status byte (byte 3) set to hexadecimal value 40H and decimal value 64.

(\*3) The data groups are arranged according to the key codes.

- When no key codes are present, the data shown below (beginning with Header and ending with NUL) is sent.

Send data	Hexadecimal	Decimal	Data length
Header	37H	55	1 byte
Identifier	73H	115	1 byte
Identification status	40H	64	1 byte
NUL	00H	0	1 byte

- Do not use this function in conjunction with downloaded bit images (**GS** \*) or user-defined characters (**ESC &**).
- See previous [Notes for transmission process] for process sending data group.
- See previous [Notes for ESC/POS Handshaking Protocol] for ESC/POS Handshaking Protocol.

[Model-dependent variations]

**TM-T90, TM-T88IV, TM-T70, TM-L90, TM-P60**

**TM-T90, TM-T88IV, TM-T70, TM-L90, TM-P60**

**This printer does not support this function.**

## GS ( L *pL* *pH* *m* *fn* *d1* *d2* *d3* <Function 81>

---

[Name]	Delete all NV graphics data.										
[Format]	ASCII	GS	(	L	<b>pL</b>	<b>pH</b>	<b>m</b>	<b>fn</b>	<b>d1</b>	<b>d2</b>	<b>d3</b>
	Hex	1D	28	4C	05	00	30	51	43	4C	52
	Decimal	29	40	76	5	0	48	81	67	76	82
[Range]	<b>(pL + pH × 256) = 5 (pL = 5, pH = 0)</b> <b>m = 48</b> <b>fn = 65</b> <b>d1 = 67</b> <b>d2 = 76</b> <b>d3 = 82</b>										
[Description]	Deletes all downloaded graphics data that has been defined using Functions 83 and 84. <ul style="list-style-type: none"> <li>Deleted areas are designated "Unused areas."</li> <li>All key codes are designated as undefined.</li> </ul>										
[Notes]	<ul style="list-style-type: none"> <li>■ Use this function at the beginning of the line when the standard mode is selected.</li> <li>■ This function is incompatible with macros, so be sure to avoid including it when defining macros.</li> <li>■ When downloaded graphics data is being shared by multiple applications, executing this function will delete all data being used by all applications. Caution is required when using this function.</li> </ul>										
[Model-dependent variations]	<b>TM-T90, TM-T88IV, TM-T70, TM-L90, TM-P60</b>										

**TM-T90, TM-T88IV, TM-T70, TM-L90, TM-P60**

**This printer does not support this function.**



## GS ( L *pL pH m fn kc1 kc2* <Function 82 >

---

[Name] Delete the specified download graphics data.

[Format]

ASCII	GS (	L	<b>pL</b>	<b>pH</b>	<b>m</b>	<b>fn</b>	<b>kc1</b>	<b>kc2</b>
Hex	1D 28	4C	04	00	30	52	<b>kc1</b>	<b>kc2</b>
Decimal	29 40	76	4	0	48	82	<b>kc1</b>	<b>kc2</b>

[Range] (**pL** + **pH** × 256) = 4    (**pL** = 4, **pH** = 0)  
**m** = 48  
**fn** = 82  
32 ≤ **kc1** ≤ 126  
32 ≤ **kc2** ≤ 126

[Description] Deletes the downloaded graphics data defined by the key codes (**kc1** and **kc2**).

- Deleted areas are designated “Unused areas.”
- Deleted key codes are designated as undefined.

[Notes] ■ Use this function at the beginning of the line when the standard mode is selected.

■ This function is incompatible with macros, so be sure to avoid including it when defining macros.

[Model-dependent variations]            **TM-T90, TM-T88IV, TM-T70, TM-L90, TM-P60**

**TM-T90, TM-T88IV, TM-T70, TM-L90, TM-P60**

**This printer does not support this function.**

# CONFIDENTIAL

**GS ( L pL pH m fn a kc1 kc2 b xL xH yL yH [c d1...dk]1...[c d1...dk]b <Function 83 >**

**GS 8 L p1 p2 p3 p4 m fn a kc1 kc2 b xL xH yL yH [c d1...dk]1...[c d1...dk]b**

[Name]	Define the downloaded graphics data (raster format).																						
[Format]	ASCII	GS	(	L	<b>pL</b>	<b>pH</b>	<b>m</b>	<b>fn</b>	<b>a</b>	<b>kc1</b>	<b>kc2</b>	<b>b</b>	<b>xL</b>	<b>xH</b>	<b>yL</b>	<b>yH</b>	<b>[c</b>	<b>d1...dk]</b>	<b>1...[c</b>	<b>d1...dk]</b>	<b>b</b>		
	Hex	1D	28	4C	<b>pL</b>	<b>pH</b>	30	53	30	<b>kc1</b>	<b>kc2</b>	<b>b</b>	<b>xL</b>	<b>xH</b>	<b>yL</b>	<b>yH</b>	<b>[c</b>	<b>d1...dk]</b>	<b>1...[c</b>	<b>d1...dk]</b>	<b>b</b>		
	Decimal	29	40	76	<b>pL</b>	<b>pH</b>	48	83	48	<b>kc1</b>	<b>kc2</b>	<b>b</b>	<b>xL</b>	<b>xH</b>	<b>yL</b>	<b>yH</b>	<b>[c</b>	<b>d1...dk]</b>	<b>1...[c</b>	<b>d1...dk]</b>	<b>b</b>		
	ASCII	GS	8	L	<b>p1</b>	<b>p2</b>	<b>p3</b>	<b>p4</b>	<b>m</b>	<b>fn</b>	<b>a</b>	<b>kc1</b>	<b>kc2</b>	<b>b</b>	<b>xL</b>	<b>xH</b>	<b>yL</b>	<b>yH</b>	<b>[c</b>	<b>d1...dk]</b>	<b>1...[c</b>	<b>d1...dk]</b>	<b>b</b>
	Hex	1D	38	4C	<b>p1</b>	<b>p2</b>	<b>p3</b>	<b>p4</b>	30	53	30	<b>kc1</b>	<b>kc2</b>	<b>b</b>	<b>xL</b>	<b>xH</b>	<b>yL</b>	<b>yH</b>	<b>[c</b>	<b>d1...dk]</b>	<b>1...[c</b>	<b>d1...dk]</b>	<b>b</b>
	Decimal	29	56	76	<b>p1</b>	<b>p2</b>	<b>p3</b>	<b>p4</b>	48	83	48	<b>kc1</b>	<b>kc2</b>	<b>b</b>	<b>xL</b>	<b>xH</b>	<b>yL</b>	<b>yH</b>	<b>[c</b>	<b>d1...dk]</b>	<b>1...[c</b>	<b>d1...dk]</b>	<b>b</b>
[Range]	$12 \leq (\mathbf{pL} + \mathbf{pH} \times 256) \leq 65535$ $(0 \leq \mathbf{pL} \leq 255, 0 \leq \mathbf{pH} \leq 255)$ [When using <b>GS 8 L</b> : $12 \leq (\mathbf{p1} + \mathbf{p2} \times 256 + \mathbf{p3} \times 65536 + \mathbf{p4} \times 16777216) \leq 4294967295$ $\mathbf{m} = 48, \mathbf{fn} = 83, \mathbf{a} = 48$ $32 \leq \mathbf{kc1} \leq 126$ $32 \leq \mathbf{kc2} \leq 126$ <b>TM-J2000/J2100:</b> $\mathbf{b} = 1, 2$ (TM-J2100 [two-color printing model]: when $\mathbf{c} = 49, 50$ ) $\mathbf{b} = 1$ (TM-J2100: when $\mathbf{c} = 51$ or TM-J2000 [single-color printing model]) $1 \leq (\mathbf{xL} + \mathbf{xH} \times 256) \leq 8192$ ( $0 \leq \mathbf{xL} \leq 255, 0 \leq \mathbf{xH} \leq 32$ ) $1 \leq (\mathbf{yL} + \mathbf{yH} \times 256) \leq 2304$ ( $0 \leq \mathbf{yL} \leq 255, 0 \leq \mathbf{yH} \leq 9$ ) $49 \leq \mathbf{c} \leq 51$ (TM-J2100 [two-color printing model]) $\mathbf{c} = 49$ (TM-J2000 [single-color printing model])																						

# CONFIDENTIAL

[Description]

Defines the downloaded graphics data (raster format) as a record specified by the key codes (**kc1** and **kc2**) in the downloaded graphics area.

- **b** specifies the number of colors for the defined data.
- **XL** and **XH** specify the number of dots in the horizontal direction as (**XL** + **XH** × 256).
- **YL** and **YH** specify the number of dots in the vertical direction as (**YL** + **YH** × 256).
- **c** specifies the color of the defined data.

<b>c</b>	<b>Color specifications</b>
49	Color 1
50	Color 2
51	Colors 3

- **d** specifies the defined data (raster format).
- **k** indicates the number of the definition data. **k** is an explanation parameter; therefore it does not need to be transmitted.

■ In cases where the specified key code already exists in memory, it will be necessary to overwrite the data.

[Notes]

■ Downloaded graphics indicate image data groups defined in the printer's internal volatile memory (RAM). Once the download graphics data have been defined, they are available until **GS ( L <Function 83>**, **<Function 84>** or **ESC @** is executed. The download graphics data are lost when the power is turned off or the printer is reset.

■ The functions used to define downloaded graphics data are this function and Function 84. Even with printer models that support both, it is recommended that only one of the functions be used for data definition tasks.

- The two functions differ only in that one function (this function) defines data in raster format, while the other (Function 84) defines data in column format. The domains and control information are identical.
- In cases where the key code specified by this function coincides with a key code being used by Function 84, a new data definition is created.

■ Use this function at the beginning of the line when the standard mode is selected.

- This function is incompatible with macros, so make sure to avoid including it when defining macros.
- In cases where there is insufficient capacity available for storing downloaded graphics data, this function cannot be used. Use Function 52 to confirm the available capacity in the downloaded graphics data area.
- One option is to delete items of downloaded graphics data that were previously defined to the same key code.
- The data for byte **k** of **d1 ... dk** is processed as a single item of defined downloaded graphics data. The defined data (**d**) specifies "1" for bits corresponding to dots that will be printed and "0" for bits corresponding to dots that will not be printed.
- Downloaded graphics data is defined using the dot density set by Function 49.
- Specify single data groups [**c d1 ... dk**] when monochrome is selected (**b** = 1) as the color.
- Specify **b** number of data groups [**c d1 ... dk**] when multiple colors are selected (**b** ≠ 1). It is also important to specify different colors in units of data groups when specifying color (**c**).
- Downloaded graphics data is printed using Function 85.
- Note that it is not possible to create definitions for both downloaded graphics data (this command) and downloaded bit image data (**GS \***). Downloaded bit image data definitions are deleted when this command is used.
- For some models, downloaded graphics (this command) and user-defined characters (**ESC &**) cannot be defined simultaneously.
  - User-defined characters defined are deleted by using this command.
  - Downloaded graphics data are deleted by **ESC &**.
- The relationship between downloaded graphics data (raster format) and print results is shown in the table below.

<b>d1</b>	<b>d2</b>	...	<b>dx</b>
<b>dx+1</b>	<b>dx+2</b>	...	<b>dx+2</b>
:	:	...	:
...	<b>dk-2</b>	<b>dk-1</b>	<b>dk</b>

$$\mathbf{X} = (\mathbf{xL} + \mathbf{xH} \times 256)$$

[Model-dependent variations]

**TM-J2000/J2100**, **TM-T90**, **TM-T88IV**, **TM-T70**, **TM-L90**, **TM-P60**

## **TM-J2000/J2100**

This printer is equipped with a print head configured in column format, which makes it faster to define data using Function 84 (column format) than with this function.

The [data value (k) + control information data value (16 bytes)] area of the NV graphics data domain is used when this function is executed.

**TM-T90**, **TM-T88IV**, **TM-T70**, **TM-L90**, **TM-P60**

This printer does not support this function.

# CONFIDENTIAL

**GS ( L pL pH m fn a kc1 kc2 b xL xH yL yH [c d1...dk]1...[c d1...dk]b** <Function 84>

**GS 8 L p1 p2 p3 p4 m fn a kc1 kc2 b xL xH yL yH [c d1...dk]1...[c d1...dk]b**

[Name] Define the downloaded graphics data (column format).

[Format]	ASCII	GS	(	L	<b>pL</b>	<b>pH</b>	<b>m</b>	<b>fn</b>	<b>a</b>	<b>kc1</b>	<b>kc2</b>	<b>b</b>	<b>xL</b>	<b>xH</b>	<b>yL</b>	<b>yH</b>	<b>[c d1...dk]1...[c d1...dk]b</b>		
	Hex	1D	28	4C	<b>pL</b>	<b>pH</b>	30	44	30	<b>kc1</b>	<b>kc2</b>	<b>b</b>	<b>xL</b>	<b>xH</b>	<b>yL</b>	<b>yH</b>	<b>[c d1...dk]1...[c d1...dk]b</b>		
	Decimal	29	40	76	<b>pL</b>	<b>pH</b>	48	68	48	<b>kc1</b>	<b>kc2</b>	<b>b</b>	<b>xL</b>	<b>xH</b>	<b>yL</b>	<b>yH</b>	<b>[c d1...dk]1...[c d1...dk]b</b>		
	ASCII	GS	8	L	<b>p1</b>	<b>p2</b>	<b>p3</b>	<b>p4</b>	<b>m</b>	<b>fn</b>	<b>akc1</b>	<b>kc2</b>	<b>b</b>	<b>xL</b>	<b>xH</b>	<b>yL</b>	<b>yH</b>	<b>[c d1...dk]1...[c d1...dk]b</b>	
	Hex	1D	38	4C	<b>p1</b>	<b>p2</b>	<b>p3</b>	<b>p4</b>	30	44	30	<b>kc1</b>	<b>kc2</b>	<b>b</b>	<b>xL</b>	<b>xH</b>	<b>yL</b>	<b>yH</b>	<b>[c d1...dk]1...[c d1...dk]b</b>
	Decimal	29	56	76	<b>p1</b>	<b>p2</b>	<b>p3</b>	<b>p4</b>	48	68	48	<b>kc1</b>	<b>kc2</b>	<b>b</b>	<b>xL</b>	<b>xH</b>	<b>yL</b>	<b>yH</b>	<b>[c d1...dk]1...[c d1...dk]b</b>

[Range]  $12 \leq (\mathbf{pL} + \mathbf{pH} \times 256) \leq 65535$  ( $0 \leq \mathbf{pL} \leq 255$ ,  $0 \leq \mathbf{pH} \leq 255$ )

[When using **GS 8 L**:  $12 \leq (\mathbf{p1} + \mathbf{p2} \times 256 + \mathbf{p3} \times 65536 + \mathbf{p4} \times 16777216) \leq 4294967295$ ]

**m** = 48, **fn** = 83, **a** = 48

$32 \leq \mathbf{kc1} \leq 126$

$32 \leq \mathbf{kc2} \leq 126$

$0 \leq \mathbf{d} \leq 255$

$\mathbf{k} = (\mathbf{xL} + \mathbf{xH} \times 256) \times (\text{int}((\mathbf{yL} + \mathbf{yH} \times 256) + 7)/8)$

**TM-J2000/J2100:** **b** = 1, 2 (TM-J2100 [two-color printing model]: when **c** = 49, 50)

**b** = 1 (TM-J2100 [two-color printing model]: when **c** = 51 or  
TM-J2000 [single-color printing model])

$1 \leq (\mathbf{xL} + \mathbf{xH} \times 256) \leq 8192$  ( $0 \leq \mathbf{xL} \leq 255$ ,  $0 \leq \mathbf{xH} \leq 32$ )

$1 \leq (\mathbf{yL} + \mathbf{yH} \times 256) \leq 2304$  ( $0 \leq \mathbf{yL} \leq 255$ ,  $0 \leq \mathbf{yH} \leq 9$ )

$49 \leq \mathbf{c} \leq 51$  (TM-J2100 [two-color printing model])

**c** = 49 (TM-J2000 [single-color printing model])

# CONFIDENTIAL

[Description]

Defines the downloaded graphics data (column format) as a record specified by the key codes (**kc1** and **kc2**) in the downloaded graphics area.

- **b** specifies the number of colors for the defined data.
- **XL** and **XH** specify the number of dots in the horizontal direction as  $(XL + XH \times 256)$ .
- **YL** and **YH** specify the number of dots in the vertical direction as  $(YL + YH \times 256)$ .
- **c** specifies the color of the defined data.

<b>c</b>	<b>Color specification</b>
49	Color 1
50	Color 2
51	Color 3

- **d** specifies the defined data (raster format).
- **k** indicates the number of the definition data. **k** is an explanation parameter; therefore it does not need to be transmitted.

■ In cases where the specified key code already exists in memory, it will be necessary to overwrite the data.

[Notes]

■ Downloaded graphics indicate image data groups defined in the printer's internal volatile memory (RAM). Once the download graphics data have been defined, they are available until **GS ( L <Function 83>**, **<Function 84>** or **ESC @** is executed. The download graphics data are lost when the power is turned off or the printer is reset.

■ The functions used to define download graphics data are this function and Function 83. Even with printer models that support both, it is recommended that only one of the functions be used for data definition tasks.

- The two functions differ only in that one function (this function) defines data in raster format, while the other (Function 83) defines data in column format. The domains and control information are identical.
- In cases where the key code specified by this function coincides with a key code being used by Function 83, a new data definition is created.

■ Use this function at the beginning of the line when the standard mode is selected.

- This function is incompatible with macros, so make sure to avoid including it when defining macros.
- In cases where there is insufficient capacity available for storing download graphics data, this function cannot be used. Use Function 52 to confirm the available capacity in the download graphics data area.
- One option is to delete items of download graphics data that were previously defined to the same key code.
- The data for byte **k** of **d1 ... dk** is processed as a single item of defined download graphics data. The defined data (**d**) specifies "1" for bits corresponding to dots that will be printed and "0" for bits corresponding to dots that will not be printed.
- Download graphics data is defined using the dot density set by Function 49.
- Specify single data groups [**c d1 ... dk**] when monochrome is selected (**b** = 1) as the color.
- Specify **b** number of data groups [**c d1 ... dk**] when multiple colors are selected (**b** ≠ 1). It is also important to specify different colors in units of data groups when specifying color (**c**).
- Download graphics data is printed using Function 85.
- Note that it is not possible to create definitions for both download graphics data (this command) and download bit image data (**GS \***). download bit image data definitions are deleted when this command is used.
- For some models, downloaded graphics (this command) and user-defined characters (**ESC &**) cannot be defined simultaneously.
  - User-defined characters defined are deleted by using this command.
  - Downloaded graphics data are deleted by **ESC &**.
- The relationship between download graphics data (column format) and print results is shown in the table below.

<b>d1</b>	<b>dy+1</b>	...	:
<b>d2</b>	<b>dy+2</b>	...	<b>dk-2</b>
:	:	...	<b>dk-1</b>
<b>dy</b>	<b>dyx2</b>	...	<b>dk</b>

$$Y = (y_L + y_H \times 256)$$

[Model-dependent variations]

**TM-J2000/J2100**, **TM-T90**, **TM-T88IV**, **TM-T70**, **TM-L90**, **TM-P60**



## **TM-J2000/J2100**

This printer is equipped with a print head configured in column format, which makes it faster to define data using this function than with Function 67 (raster format).

The [data value (k) + control information data value (16 bytes)] area of the NV graphics data domain is used when this function is executed.

## **TM-T90, TM-T88IV, TM-T70, TM-L90, TM-P60**

This printer does not support this function.

## GS ( L *pL pH m fn kc1 kc2 x y* <Function 85>

---

[Name]	Print the specified download graphics data.																																	
[Format]	<table border="0"> <tr> <td>ASCII</td> <td>GS (</td> <td>L</td> <td><b>pL</b></td> <td><b>pH</b></td> <td><b>m</b></td> <td><b>fn</b></td> <td><b>kc1</b></td> <td><b>kc2</b></td> <td><b>x</b></td> <td><b>y</b></td> </tr> <tr> <td>Hex</td> <td>1D 28</td> <td>4C</td> <td>06</td> <td>00</td> <td>30</td> <td>55</td> <td><b>kc1</b></td> <td><b>kc2</b></td> <td><b>x</b></td> <td><b>y</b></td> </tr> <tr> <td>Decimal</td> <td>29 40</td> <td>76</td> <td>6</td> <td>0</td> <td>48</td> <td>85</td> <td><b>kc1</b></td> <td><b>kc2</b></td> <td><b>x</b></td> <td><b>y</b></td> </tr> </table>	ASCII	GS (	L	<b>pL</b>	<b>pH</b>	<b>m</b>	<b>fn</b>	<b>kc1</b>	<b>kc2</b>	<b>x</b>	<b>y</b>	Hex	1D 28	4C	06	00	30	55	<b>kc1</b>	<b>kc2</b>	<b>x</b>	<b>y</b>	Decimal	29 40	76	6	0	48	85	<b>kc1</b>	<b>kc2</b>	<b>x</b>	<b>y</b>
ASCII	GS (	L	<b>pL</b>	<b>pH</b>	<b>m</b>	<b>fn</b>	<b>kc1</b>	<b>kc2</b>	<b>x</b>	<b>y</b>																								
Hex	1D 28	4C	06	00	30	55	<b>kc1</b>	<b>kc2</b>	<b>x</b>	<b>y</b>																								
Decimal	29 40	76	6	0	48	85	<b>kc1</b>	<b>kc2</b>	<b>x</b>	<b>y</b>																								
[Range]	<p><b>(pL + pH × 256) = 6</b>    <b>(pL = 6, pH = 0)</b></p> <p><b>m = 48</b></p> <p><b>fn = 85</b></p> <p><math>32 \leq \mathbf{kc1} \leq 126</math></p> <p><math>32 \leq \mathbf{kc2} \leq 126</math></p> <p><b>TM-J2000/J2100: x = 1, 2, y = 1, 2</b></p>																																	
[Description]	<p>Prints the downloaded graphics data defined by the key codes (<b>kc1</b> and <b>kc2</b>).</p> <ul style="list-style-type: none"> <li>• Users have the option of specifying horizontal (times <b>x</b>) × vertical (times <b>y</b>) size settings for the selected data.</li> </ul>																																	
[Notes]	<ul style="list-style-type: none"> <li>■ This function is used to print downloaded graphics data defined using Functions 83 and 84 of this command.</li> <li>■ The printer only prints when downloaded graphics data corresponding to the specified key code is present.</li> <li>■ Use this function when the printer enters the “beginning of the line” or “no data in print buffer” state during the standard mode.</li> <li>■ Note that during the page mode, printing operations will not be performed simply because image data has been stored to the print buffer.</li> <li>■ Downloaded graphics data that exceeds the print area for one line will not be printed.</li> <li>■ The scales for width and height of graphics are specified by (<b>x</b>, <b>y</b>). Therefore, in page mode with 90° or 270° clockwise rotated graphics, the printer applies print area and dot density from [<b>x</b>: direction of paper feed, <b>y</b>: perpendicular to direction of paper feed].</li> <li>■ Settings for text effect (bold, underline, orientation, etc. except for upside-down) and font size do not affect the printing of the downloaded graphics data.</li> </ul>																																	

- Feeds the paper the required distance when printing graphics data, regardless of line feed pitch settings entered using the Set line feed command.
- Moves print position to the left side of the print area after printing of graphics data is completed. The printer then enters the “beginning of the line” or “no data in print buffer” state.
- When printing downloaded graphic files, use **ESC U** to specify unidirectional print for vertical alignment of printed text.

[Model-dependent variations]

**TM-J2000/J2100**, **TM-T90**, **TM-T88IV**, **TM-T70**, **TM-L90**, **TM-P60**

## **TM-J2000/J2100**

The model information for this function (the dot density and maximum print area and others) is same as Function 69. See the model information of Function 69.

**TM-T90**, **TM-T88IV**, **TM-T70**, **TM-L90**, **TM-P60**

This printer does not support this function.

## **GS ( L pL pH m fn a bx by c xL xH yL yH d1...dk** <Function 112>

---

## **GS 8 L p1 p2 p3 p4 m fn a bx by c xL xH yL yH d1...dk**

---

[Name]	Store the graphics data in the print buffer (raster format).										
[Format]	ASCII	GS	(	L	<b>pL</b>	<b>pH</b>	<b>m</b>	<b>fn</b>	<b>a</b>	<b>bx by c</b>	<b>xL xH yL yH d1...dk</b>
	Hex	1D	28	4C	<b>pL</b>	<b>pH</b>	30	70	30	<b>bx by c</b>	<b>xL xH yL yH d1...dk</b>
	Decimal	29	40	76	<b>pL</b>	<b>pH</b>	48	112	48	<b>bx by c</b>	<b>xL xH yL yH d1...dk</b>
	ASCII	GS	8	L	<b>p1</b>	<b>p2</b>	<b>p3</b>	<b>p4</b>	<b>m</b>	<b>fn a</b>	<b>bx by c xL xH yL yH d1...dk</b>
	Hex	1D	38	4C	<b>p1</b>	<b>p2</b>	<b>p3</b>	<b>p4</b>	30	70 30	<b>bx by c xL xH yL yH d1...dk</b>
	Decimal	29	56	76	<b>p1</b>	<b>p2</b>	<b>p3</b>	<b>p4</b>	48	112 48	<b>bx by c xL xH yL yH d1...dk</b>
[Range]	$11 \leq (\mathbf{pL} + \mathbf{pH} \times 256) \leq 65535$ ( $0 \leq \mathbf{pL} \leq 255, 0 \leq \mathbf{pH} \leq 255$ ) [When using <b>GS 8 L</b> : $11 \leq (\mathbf{p1} + \mathbf{p2} \times 256 + \mathbf{p3} \times 65536 + \mathbf{p4} \times 16777216) \leq 4294967295$ $\mathbf{m} = 48, \mathbf{fn} = 112, \mathbf{a} = 48$ $0 \leq \mathbf{d} \leq 255$ $\mathbf{k} = (\text{int}((\mathbf{xL} + \mathbf{xH} \times 256) + 7)/8) \times (\mathbf{yL} + \mathbf{yH} \times 256)$ <b>TM-J2000/J2100:</b> <b>bx = 1, 2</b> <b>by = 1, 2</b> $49 \leq \mathbf{c} \leq 51$ ( <b>TM-J2100 [two-color printing model]</b> ) $\mathbf{c} = 49$ ( <b>TM-J2000 [single-printing model]</b> ) $1 \leq (\mathbf{xL} + \mathbf{xH} \times 256) \leq 2048$ ( $0 \leq \mathbf{xL} \leq 255, 0 \leq \mathbf{xH} \leq 8$ ) $1 \leq (\mathbf{yL} + \mathbf{yH} \times 256) \leq 128$ ( $0 \leq \mathbf{yL} \leq 128, \mathbf{yH} = 0$ ) <b>TM-T90:</b> <b>bx = 1, 2</b> <b>by = 1, 2</b> $\mathbf{c} = 49$ (when the recommended monochrome paper is used) $\mathbf{c} = 49, 50$ (when the recommended two-color paper is used) $1 \leq (\mathbf{xL} + \mathbf{xH} \times 256) \leq 1024$ ( $0 \leq \mathbf{xL} \leq 255, 0 \leq \mathbf{xH} \leq 4$ ) [Other than Japanese Model] With recommended two-color paper <b>(by = 1):</b> $1 \leq (\mathbf{yL} + \mathbf{yH} \times 256) \leq 831$ ( $0 \leq \mathbf{yL} \leq 255, 0 \leq \mathbf{yH} \leq 3$ ) <b>(by = 2):</b> $1 \leq (\mathbf{yL} + \mathbf{yH} \times 256) \leq 415$ ( $0 \leq \mathbf{yL} \leq 255, \mathbf{yH} = 0, 1$ ) With recommended monochrome paper										

**(by = 1):  $1 \leq (y_L + y_H \times 256) \leq 1662$  ( $0 \leq y_L \leq 255, 0 \leq y_H \leq 6$ )**

**(by = 2):  $1 \leq (y_L + y_H \times 256) \leq 831$  ( $0 \leq y_L \leq 255, 0 \leq y_H \leq 3$ )**

**[Japanese Model]**

**With recommended two-color paper**

**(by = 1):  $1 \leq (y_L + y_H \times 256) \leq 738$  ( $0 \leq y_L \leq 255, 0 \leq y_H \leq 2$ )**

**(by = 2):  $1 \leq (y_L + y_H \times 256) \leq 369$  ( $0 \leq y_L \leq 255, y_H = 0, 1$ )**

**With recommended monochrome paper**

**(by = 1):  $1 \leq (y_L + y_H \times 256) \leq 1476$  ( $0 \leq y_L \leq 255, 0 \leq y_H \leq 5$ )**

**(by = 2):  $1 \leq (y_L + y_H \times 256) \leq 738$  ( $0 \leq y_L \leq 255, 0 \leq y_H \leq 2$ )**

**TM-T88IV:**

**bx = 1, 2**

**by = 1, 2**

**c = 49 (when single-color printing control is selected)**

**c = 49, 50 (when two-color printing control is selected)**

**$1 \leq (x_L + x_H \times 256) \leq 2047$  ( $0 \leq x_L \leq 255, 0 \leq x_H \leq 7$ )**

**[When single-color printing control is selected]**

**(by = 1):  $1 \leq (y_L + y_H \times 256) \leq 1662$  ( $0 \leq y_L \leq 255, 0 \leq y_H \leq 6$ )**

**(by = 2):  $1 \leq (y_L + y_H \times 256) \leq 831$  ( $0 \leq y_L \leq 255, 0 \leq y_H \leq 3$ )**

**[When two-color printing control is selected]**

**(by = 1):  $1 \leq (y_L + y_H \times 256) \leq 831$  ( $0 \leq y_L \leq 255, 0 \leq y_H \leq 3$ )**

**(by = 2):  $1 \leq (y_L + y_H \times 256) \leq 415$  ( $0 \leq y_L \leq 255, y_H = 0, 1$ )**

**TM-T70:**

**bx = 1, 2**

**by = 1, 2**

**c = 49**

**$1 \leq (x_L + x_H \times 256) \leq 2047$  ( $0 \leq x_L \leq 255, 0 \leq x_H \leq 7$ )**

**(by = 1):  $1 \leq (y_L + y_H \times 256) \leq 1662$  ( $0 \leq y_L \leq 255, 0 \leq y_H \leq 6$ )**

**(by = 2):  $1 \leq (y_L + y_H \times 256) \leq 831$  ( $0 \leq y_L \leq 255, 0 \leq y_H \leq 3$ )**

**TM-L90:**

**bx = 1, 2**

**by = 1, 2**

**c = 49, 50 (when the recommended two-color paper is used)**

**c = 49 (when the recommended monochrome paper is used)**

**$1 \leq (x_L + x_H \times 256) \leq 1024$  ( $0 \leq x_L \leq 255, 0 \leq x_H \leq 4$ )**

**With recommended two-color paper**

**(by = 1):  $1 \leq (y_L + y_H \times 256) \leq 738$  ( $0 \leq y_L \leq 255, 0 \leq y_H \leq 2$ )**

**(by = 2):  $1 \leq (y_L + y_H \times 256) \leq 369$  ( $0 \leq y_L \leq 255, y_H = 0, 1$ )**

**With recommended monochrome paper**

**(by = 1):  $1 \leq (y_L + y_H \times 256) \leq 1476$  ( $0 \leq y_L \leq 255, 0 \leq y_H \leq 5$ )**

**(by = 2):  $1 \leq (y_L + y_H \times 256) \leq 738$  ( $0 \leq y_L \leq 255, 0 \leq y_H \leq 2$ )**

**TM-P60:**

**bx = 1, 2**

**by = 1, 2**

**c = 49**

**$1 \leq (x_L + x_H \times 256) \leq 1024$  ( $0 \leq x_L \leq 255, 0 \leq x_H \leq 4$ )**

**(by = 1):  $1 \leq (y_L + y_H \times 256) \leq 1200$  ( $0 \leq y_L \leq 255, 0 \leq y_H \leq 4$ )**

**(by = 2):  $1 \leq (y_L + y_H \times 256) \leq 600$  ( $0 \leq y_L \leq 255, 0 \leq y_H \leq 2$ )**

[Description]

Stores the graphics data (raster format) in the print buffer.

- Users have the option of specifying horizontal (times **bx**) × vertical (times **by**) size settings for the selected data.
- **c** specifies the color of the stored data.

<b>c</b>	<b>Color specifications</b>
49	Color 1
50	Color 2
51	Color 3

- **xL** and **xH** specify the number of dots in the horizontal direction as  $(x_L + x_H \times 256)$ .
- **yL** and **yH** specify the number of dots in the vertical direction as  $(y_L + y_H \times 256)$ .
- **d** specifies the stored data (raster format).
- **k** indicates the number of the graphics data. **k** is an explanation parameter; therefore it does not need to be transmitted.

[Notes]

- The functions used to store graphics data directly to the print buffer are this function and Function 113. Even with printer models that support both, it is recommended that only one of the functions be used for data definition tasks.
  - The two functions differ only in that one function (this function) defines data in raster format, while the other (Function 113) defines data in column format.

- Use this function when the printer enters the “beginning of the line” or “except for graphic data, no data in print buffer” state during the standard mode.
- This function is incompatible with macros, so make sure to avoid including it when defining macros.
- NV graphics data that exceeds the print area for one line will not be printed.
- The scales for width and height of graphics are specified by (**x**, **y**). Therefore, in page mode with 90° or 270° clockwise-rotated graphics, the printer applies print area and dot density from [**x**: direction of paper feed, **y**: perpendicular to direction of paper feed].
- Settings for text effect (bold, underline, orientation) and font size do not affect the printing of the NV graphics data.
- Print position does not change before and after this function is used. Overprinting of data of multiple colors can be performed by simply changing the selected color (**c**) and running this function again, but it is not possible to specify the same color to overprint.
- Use Function 50 to print graphics after graphics data has been stored in the print buffer when the standard mode is selected.
- The data for byte **k** of **d1 ... dk** is processed as a single item of defined NV graphics data. The defined data (**d**) specifies “1” for bits corresponding to dots that will be printed and “0” for bits corresponding to dots that will not be printed.
- NV graphics data is defined using the dot density set by Function 49.
- During processing of this function, real time commands are not available.
- The relationship between NV graphics data (raster format) and print results is shown in the table below.

<b>d1</b>	<b>d2</b>	...	<b>dX</b>	
<b>dx+1</b>	<b>dx+2</b>	...	<b>dx+2</b>	
:	:	...	:	
...	<b>dk-2</b>	<b>dk-1</b>	<b>dk</b>	<b>X = (xL + xH × 256)</b>

[Model-dependent variations]

**TM-J2000/J2100, TM-T90, TM-L90, TM-T88IV, TM-T70, TM-P60**

## TM-J2000/J2100

This printer is equipped with a print head configured in column format, which makes it faster to define data using Function 113 (column format) than with this function.

The model information for this function (the dot density and maximum print area and others) is the same as for Function 69. See the model information of Function 69.

## TM-T90, TM-L90

For specifying paper (2-color/single-color), see Function 5 of **GS ( E**.

The dot density and maximum print area are the same as Function 69. See the model information of Function 69.

Use the following settings (except when using a serial interface) for fastest processing time.

- Check that there is space in the receive buffer of the printer before transmitting this function when transmitting the first graphic data. (You can check that the receive buffer is empty by executing status receiving of **GS r (n = 1, 49)**).

Example: Example of data processing:

**GS r** -> Status receiving -> This function (color 1) -> This function (color 2) -> This command <Function 50> -> This function (color 1) -> This function (color 2) -> This command <Function 50>

- Specify standard mode.
- Specify left margin as 0, and the horizontal position to a position that is a multiple of 8, and specify the horizontal size of the graphic to the dot which is the multiple of 8. (Example: the left margin = 0, horizontal position = 8, 16, or 24, 32, etc.,  $(x_L + x_H \times 256) = 64, 128, \text{ or } 256$  etc.)
- Specify the scaling to the original size (**bx = 1, by = 1**).
- Specify the size of image data not to exceed the current print area.



- ❑ A graphic that exceeds the size limit of  $(y_L + y_H \times 256)$  can be printed by the repeated use of the combination of this function and <Function 50> of this command. In that case, the performance may be best when the vertical size is specified as  $[59 \leq (y_L + y_H \times 256) \leq 246$  (reference value)] by this function. However, the value is only a reference value. The most suitable vertical size depends on the specifications of the PC, the interface used and other factors.

If the time of processing this function cannot be shortened when processing the above-mentioned item, the printing result may include horizontal stripes. In this case, transmit the graphic data specified within the maximum range of  $(y_L + y_H \times 256)$  one time to prevent the horizontal stripe but the performance will decrease.

## TM-T88IV

Refer to **GS ( E <Function 5>** for specifying printing control (single-color/two-color).

The dot density and maximum print area are the same as Function 69. See the model information of Function 69.

Use the following settings (except when using a serial interface) for fastest processing time.

- ❑ Check that there is space in the receive buffer of the printer before transmitting this function when transmitting the first graphic data. (You can check that the receive buffer is empty by executing status receiving of **GS r (n = 1, 49)**).

Example: Example of data processing:

**GS r** -> Status receiving -> This function (color 1) -> This function (color 2) -> This command <Function 50> -> This function (color 1) -> This function (color 2) -> This command <Function 50>

- ❑ Specify standard mode.
- ❑ Specify "Left-justified" with **ESC a**.
- ❑ Specify left margin as 0, and the horizontal position to a position that is a multiple of 8, and specify the horizontal size of the graphic to the dot which is the multiple of 8. (Example: the left margin = 0, horizontal position = 8, 16, or 24, 32, etc.,  $(x_L + x_H \times 256) = 64, 128, \text{ or } 256$  etc.)
- ❑ Specify the scaling to the original size (**bx = 1, by = 1**).
- ❑ Specify the size of image data not to exceed the current print area.

# CONFIDENTIAL

- ❑ **Do not specify data again for already saved colors.**  
**Example: Specifying (Color 1 -> Color 2 -> Color 1 -> Print) causes a drop in performance.**
- ❑ **A graphic that exceeds the size limit of  $(y_L + y_H \times 256)$  can be printed by the repeated use of the combination of this function and <Function 50> of this command. In that case, the performance may be best when the vertical size is specified less than half of the domain by this function. The most suitable vertical size depends on the specifications of the PC, the interface used and other factors.**

**Example:  $(y_L + y_H \times 256) \leq 831$  (when zoom of (by=1 is specified)) when single-color printing control is specified.**

**With the above method, if banding appears in the print results and the processing time is not reduced, it is possible that data transmission from the PC is not fast enough for the processing time of the printer. Check the PC data transmission speed.**

**If there is a problem with the PC, it may be possible to prevent banding occurring by slowing down printing speed with **GS ( K <Function 50>** or by increasing the number of head energizing strokes with **GS ( K <Function 97>**, but the performance will decrease.**

## TM-T70

The dot density and maximum print area are the same as Function 69. See the model information of Function 69.

Use the following settings (except when using a serial interface) for fastest processing time.

- ❑ Check that there is space in the receive buffer of the printer before transmitting this function when transmitting the first graphic data. (You can check that the receive buffer is empty by executing status receiving of **GS r (n = 1, 49)**).

**Example: Example of data processing**

**GS r -> Status receiving -> This function -> This command <Function 50> -> This function -> This command <Function 50>**

- ❑ Specify standard mode.
- ❑ Specify "Left-justified" with **ESC a**.

# CONFIDENTIAL

- ❑ Specify left margin as 0, and the horizontal position to a position that is a multiple of 8, and specify the horizontal size of the graphic to the dot which is the multiple of 8.  
(Example: the left margin = 0, horizontal position = 8, 16, or 24, 32, etc.,  $(x_L + x_H \times 256) = 64, 128,$  or 256 etc.)
- ❑ Specify the scaling to the original size (**bx = 1, by = 1**).
- ❑ Specify the size of image data not to exceed the current print area.
- ❑ A graphic that exceeds the size limit of  $(y_L + y_H \times 256)$  can be printed by the repeated use of the combination of this function and <Function 50> of this command. In that case, the performance may be best when the vertical size is specified less than half of the domain by this function. The most suitable vertical size depends on the specifications of the PC, the interface used and other factors.

With the above method, if banding appears in the print results and the processing time is not reduced, it is possible that data transmission from the PC is not fast enough for the processing time of the printer. Check the PC data transmission speed.

If there is a problem with the PC, it may be possible to prevent banding occurring by slowing down printing speed with **GS ( K <Function 50>** or by increasing the number of head energizing strokes with **GS ( K <Function 97>**, but the performance will decrease.

## TM-P60

This function cannot be used when the printer enters the “beginning of the line” or “data in print buffer” state during the standard mode.

The dot density and maximum print area are the same as Function 69. See the model information of Function 69.

Use the following settings for fastest processing time.

- ❑ Not RS-232 serial interface communication.
- ❑ Specify standard mode.
- ❑ Specify left margin as 0, and the horizontal position to a position that is a multiple of 8.  
(Example: the left margin = 0, horizontal position = 0, 8, 16, or 24, etc.)
- ❑ Specify the scaling to the original size (**bx = 1, by = 1**).

# CONFIDENTIAL

- ❑ Specify the size of image data not to exceed the current print area.
- ❑ A graphic that exceeds the size limit of  $(y_L + y_H \times 256)$  can be printed by the repeated use of the combination of this function and <Function 50> of this command. In that case, the performance may be best when the vertical size is specified as  $[120 \leq (y_L + y_H \times 256) \leq 400 \text{ (reference value)}]$  by this function. However, the value is only a reference value. The most suitable vertical size depends on the specifications of the PC or radio frequency energy transmitted by wireless communication.

If the time of processing this function cannot be shortened when processing the above-mentioned item, the printing result may include horizontal stripes. In this case, transmit the graphic data specified within the maximum range of  $(y_L + y_H \times 256)$  one time to prevent the horizontal stripe but the performance will decrease.

## **GS ( L p<sub>L</sub> p<sub>H</sub> m fn a bx by c x<sub>L</sub> x<sub>H</sub> y<sub>L</sub> y<sub>H</sub> d1...dk** <Function 113>

### **GS 8 L p1 p2 p3 p4 m fn a bx by c x<sub>L</sub> x<sub>H</sub> y<sub>L</sub> y<sub>H</sub> d1...dk**

[Name] Store the graphics data in the print buffer (column format).

[Format]

ASCII	GS	(	L	<b>p<sub>L</sub></b>	<b>p<sub>H</sub></b>	<b>m</b>	<b>fn</b>	<b>a</b>	<b>bx by c x<sub>L</sub> x<sub>H</sub> y<sub>L</sub> y<sub>H</sub> d1...dk</b>
Hex	1D	28	4C	<b>p<sub>L</sub></b>	<b>p<sub>H</sub></b>	30	71	30	<b>bx by c x<sub>L</sub> x<sub>H</sub> y<sub>L</sub> y<sub>H</sub> d1...dk</b>
Decimal	29	40	76	<b>p<sub>L</sub></b>	<b>p<sub>H</sub></b>	48	113	48	<b>bx by c x<sub>L</sub> x<sub>H</sub> y<sub>L</sub> y<sub>H</sub> d1...dk</b>
ASCII	GS	8	L	<b>p1</b>	<b>p2</b>	<b>p3</b>	<b>p4</b>	<b>m</b>	<b>fn abx by c x<sub>L</sub> x<sub>H</sub> y<sub>L</sub> y<sub>H</sub> d1...dk</b>
Hex	1D	38	4C	<b>p1</b>	<b>p2</b>	<b>p3</b>	<b>p4</b>	30	71 30 <b>bx by c x<sub>L</sub> x<sub>H</sub> y<sub>L</sub> y<sub>H</sub> d1...dk</b>
Decimal	29	56	76	<b>p1</b>	<b>p2</b>	<b>p3</b>	<b>p4</b>	48	113 48 <b>bx by c x<sub>L</sub> x<sub>H</sub> y<sub>L</sub> y<sub>H</sub> d1...dk</b>

[Range]

**11 ≤ (p<sub>L</sub> + p<sub>H</sub> × 256) ≤ 65535 (0 ≤ p<sub>L</sub> ≤ 255, 0 ≤ p<sub>H</sub> ≤ 255)**  
**[When using GS 8 L: 11 ≤ (p1 + p2 × 256 + p3 × 65536 + p4 × 16777216) ≤ 4294967295]**  
**m = 48, fn = 113, a = 48**  
**0 ≤ d ≤ 255**  
**k = (x<sub>L</sub> + x<sub>H</sub> × 256) × (int((y<sub>L</sub> + y<sub>H</sub> × 256) + 7)/8)**  
**TM-J2000/J2100: 49 ≤ c ≤ 51 (TM-J2100 [two-color printing model])**  
**c = 49 (TM-J2000 [single-color printing model])**  
**1 ≤ (x<sub>L</sub> + x<sub>H</sub> × 256) ≤ 2048 (0 ≤ x<sub>L</sub> ≤ 255, 0 ≤ x<sub>H</sub> ≤ 8)**  
**1 ≤ (y<sub>L</sub> + y<sub>H</sub> × 256) ≤ 128 (1 ≤ y<sub>L</sub> ≤ 128, y<sub>H</sub> = 0)**

[Description] Stores the graphics data (column format) in the print buffer.

- Users have the option of specifying horizontal **bx** × vertical **by** size settings for the selected data.
- **c** specifies the color of the stored data.

<b>c</b>	<b>Color specifications</b>
49	Color 1
50	Color 2
51	Color 3

- **x<sub>L</sub>** and **x<sub>H</sub>** specify the number of dots in the horizontal direction as **(x<sub>L</sub> + x<sub>H</sub> × 256)**.

- **yL** and **yH** specify the number of dots in the vertical direction as (**yL** + **yH** × 256).
- **d** specifies the stored data (column format).
- **k** indicates the number of the graphics data. **k** is an explanation parameter; therefore it does not need to be transmitted.

## [Notes]

- The functions used to store graphics data directly to the print buffer are this function and Function 112. Even with printer models that support both, it is recommended that only one of the functions be used for data definition tasks.
- The two functions differ only in that one function (this function) defines data in raster format, while the other (Function 112) defines data in column format.
- Use this function when the printer enters the “beginning of the line” or “except for graphic data, no data in print buffer” state during the standard mode.
- This function is incompatible with macros, so make sure to avoid including it when defining macros.
- Graphics data that exceeds the print area for one line will not be printed.
- The scales for width and height of graphics are specified by (**x**, **y**). Therefore, in page mode with 90° or 270° clockwise-rotated graphics, the printer applies print area and dot density from [**x**: direction of paper feed, **y**: perpendicular to direction of paper feed].
- Settings for text effect (bold, underline, orientation) and font size do not affect the printing of the graphics data.
- Print position does not change before and after this function is used. Overprinting of data of multiple colors can be performed by simply changing the selected color (**c**) and running this function again, but it is impossible to specify the same color to overprint.
- Use Function 50 to print graphics after graphics data has been stored in the print buffer when the standard mode is selected.
- The data for byte **k** of **d1 ... dk** is processed as a single item of defined graphics data. The defined data (**d**) specifies “1” for bits corresponding to dots that will be printed and “0” for bits corresponding to dots that will not be printed.
- Graphics data is defined using the dot density set by Function 49.
- During processing of this function, real time commands aren’t available.

- The relationship between graphics data (column format) and print results is shown in the table below.

<b>d1</b>	<b>dv+1</b>	...	:
<b>d2</b>	<b>dv+2</b>	...	<b>dk-2</b>
:	:	...	<b>dk-1</b>
<b>dv</b>	<b>dvx2</b>	...	<b>dk</b>

**Y = (yL + yH × 256)**

- This printer is equipped with a print head configured in column format, which makes it faster to define data using this function (column format) than with Function 112 (raster format).

[Model-dependent variations]

**TM-J2000/J2100, TM-T90, TM-T88IV, TM-T70, TM-L90, TM-P60**

## TM-J2000/J2100

This printer is equipped with a print head configured in column format, which makes it faster to define data using Function 113 (column format) than with this function.

Use the following settings for best performance.

- Specify the horizontal size of graphics as 64 dots and horizontal single ¥ vertical single size settings [(yL + yH × 256) = 64, bx = 1, by = 1] when setting the dot density to [180 dpi × 180 dpi] with Function 49.
- Specify the horizontal size of graphics as 128 dots and horizontal single ¥ vertical single size settings [(yL + yH × 256) = 128, bx = 1, by = 1] when setting the dot density to [360 dpi × 360 dpi] with Function 49.

The dot density and maximum print area are the same as Function 69. See the model information of Function 69.

**TM-T90, TM-T88IV, TM-T70, TM-L90, TM-P60**

This printer does not support this function.

## FS q

[Name]	Define NV bit image					
[Format]	ASCII	FS	q	n	[xL xH yL yH d1...dk]1...[xL xH yL yH d1...dk]n	
	Hex	1C	71	n	[xL xH yL yH d1...dk]1...[xL xH yL yH d1...dk]n	
	Decimal	28	113	n	[xL xH yL yH d1...dk]1...[xL xH yL yH d1...dk]n	

[Printers not featuring this command] **TM-T70**, **TM-L90**, **TM-P60**, **TM-U230**

[Range]	<b>TM-J2000/J2100:</b>	$1 \leq n \leq 255$ $1 \leq (xL + xH \times 256) \leq 1023$ ( $0 \leq xL \leq 255, 0 \leq xH \leq 3$ ) $1 \leq (yL + yH \times 256) \leq 576$ ( $0 \leq yL \leq 255, 0 \leq yH \leq 2$ ) $0 \leq d \leq 255$ $k = (xL + xH \times 256) \times (yL + yH \times 256) \times 8$ The definition area is maximum 384 KB
	<b>TM-T90:</b>	$1 \leq n \leq 255$ $1 \leq (xL + xH \times 256) \leq 1023$ ( $0 \leq xL \leq 255, 0 \leq xH \leq 3$ ) $1 \leq (yL + yH \times 256) \leq 288$ ( $0 \leq yL \leq 255, yH = 0, 1$ ) $0 \leq d \leq 255$ $k = (xL + xH \times 256) \times (yL + yH \times 256) \times 8$ The definition area is maximum 384 KB
	<b>TM-T88IV:</b>	$1 \leq n \leq 255$ $1 \leq (xL + xH \times 256) \leq 1023$ ( $0 \leq xL \leq 255, 0 \leq xH \leq 3$ ) $1 \leq (yL + yH \times 256) \leq 288$ ( $0 \leq yL \leq 255, yH = 0, 1$ ) $0 \leq d \leq 255$ $k = (xL + xH \times 256) \times (yL + yH \times 256) \times 8$ The definition area is 256 KB
	<b>TM-U220:</b>	$1 \leq n \leq 255$ $1 \leq (xL + xH \times 256) \leq 1023$ ( $0 \leq xL \leq 255, 0 \leq xH \leq 3$ ) $1 \leq (yL + yH \times 256) \leq 288$ ( $0 \leq yL \leq 255, yH = 0, 1$ ) $0 \leq d \leq 255$ $k = (xL + xH \times 256) \times (yL + yH \times 256) \times 8$ The definition area is 128 KB



- [Description] Defines the NV bit image in the NV graphics area.
- **n** specifies the number of defined NV bit images.
  - **XL, XH** specifies (**XL** + **XH** × 256) bytes in the horizontal direction for the NV bit image you defined.
  - **YL, YH** specifies (**YL** + **YH** × 256) bytes in the vertical direction for the NV bit image you defined.
  - **d** specifies the definition data for the NV bit image (column format).
  - **k** indicates the number of the definition data. **k** is an explanation parameter; therefore it does not need to be transmitted.

[Recommended Functions]

This function is supported only by some printer models and may not be supported by future models. It is recommended that NV graphics function (**GS ( L GS 8 L: <Function 51>** and **<Function 64>** ~ **<Function 69>**) be used instead of **FS q** because the NV graphics function offers the following additional features:

- Multiple logo data and mark data can be specified (except for some models).
- Data can be controlled by key code.
- Redefining or deleting is possible for each key code.
- Color can be specified for the definition data.
- Data can be defined by raster format.
- The remaining capacity of the definition area can be confirmed.
- Continuous processing possible (without a software reset when a command has been processed).

- [Notes]
- NV bit image means a bit image which is defined in a non-volatile memory. The NV bit image defined is effective until the next NV bit image is defined.
  - In standard mode, this command is effective only when processed at the beginning of the line.
  - If this command is processed while a macro is being defined, the printer cancels macro definition and starts processing this command. At this time, the macro becomes undefined.
  - **k** bytes data of **d1...dk** is processed as a defined data of a NV bit image. The defined data (**d**) specifies a bit printed to 1 and not printed to 0.
  - All NV bit images previously defined are canceled.

- After processing this command, the printer executes a software reset. Therefore, processing this command enables the printer to be in the correct status when the power is turned on.
- The limitations during processing of this command are as follows:
  - Even if the PAPER FEED button is pressed, the printer does not feed paper.
  - The real-time commands are not processed.
  - Even if the ASB function is effective, the ASB status cannot be transmitted.
- The NV bit image is printed by **FS p**.
- Bit image data and print result are as follows:

<b>d1</b>	<b>dY+1</b>	...	.	MSB
			.	LSB
<b>d2</b>	<b>dY+2</b>	...	<b>dk-2</b>	MSB
				LSB
.	.	...	<b>dk-1</b>	MSB
.	.			LSB
<b>dY</b>	<b>dY×2</b>	...	<b>dk</b>	MSB
				LSB

$$Y = y_L + y_H \times 256$$

- Data is written to the non-volatile memory by this command. Note the following when using this command.
  - Do not turn off the power or reset the printer from the interface when this command is being executed.
  - The printer is BUSY when writing the data to the non-volatile memory. In this case, be sure not to transmit data from the host because the printer does not receive data.
  - Excessive use of this function may destroy the non-volatile memory. As a guideline, do not use any combination of the following commands more than 10 times per day for writing data to the non-volatile memory: **GS ( A** (part of functions), **GS ( C** (part of functions), **GS ( E** (part of functions), **GS ( L / GS 8 L** (part of functions), **GS ( M** (part of functions), **GS g 0**, **FS g 1**, **FS q**.

[Model-dependent variations] **TM-J2000/J2100, TM-T90, TM-T88IV**

See program example and print sample for FS q and FS p.

## **TM-J2000/J2100**

This printer supports the NV graphics function of **GS ( L** and **GS 8 L**.

It is recommended that NV graphics function (**GS ( L / GS 8 L**) be used.

The data of this command and record data of user NV memory (**GS ( C**) are stored in the same definition area. The total data of NV bit image and **GS ( C** record can be defined up to 384 KB.

## **TM-T90**

It is recommended that NV graphics function (**GS ( L / GS 8 L**) be used.

All definition area capacity can be selected from the following by **GS ( E <Function 5>**.

Capacity that can be selected	Default
0, 64, 128, 192, 256, 320, 384 (K)	384 (K)

## **TM-T88IV**

This printer supports the NV graphics function of **GS ( L** and **GS 8 L**.

It is recommended that NV graphics function (**GS ( L / GS 8 L**) be used.

The domain for saving data with this command is 256 KB.

[Name] Print raster bit image

[Format] ASCII GS v 0 **m xL xH yL yH d1...dk**  
 Hex 1D 76 30 **m xL xH yL yH d1...dk**  
 Decimal 29 118 48 **m xL xH yL yH d1...dk**

[Range] **TM-J2000/J2100:**  $0 \leq m \leq 3, 48 \leq m \leq 51$   
 $1 \leq (xL + xH \times 256) \leq 255$  ( $1 \leq xL \leq 255, xH = 0$ )  
 $1 \leq (yL + yH \times 256) \leq 4607$  ( $0 \leq yL \leq 255, 0 \leq yH \leq 17$ )  
 $0 \leq d \leq 255$   
 $k = (xL + xH \times 256) \times (yL + yH \times 256)$

**TM-T90, TM-L90:**  $0 \leq m \leq 3, 48 \leq m \leq 51$   
 $1 \leq (xL + xH \times 256) \leq 128$  ( $1 \leq xL \leq 128, xH = 0$ )  
 $1 \leq (yL + yH \times 256) \leq 4095$  ( $0 \leq yL \leq 255, 0 \leq yH \leq 15$ )  
 $0 \leq d \leq 255$   
 $k = (xL + xH \times 256) \times (yL + yH \times 256)$

**TM-T88IV:**  $0 \leq m \leq 3, 48 \leq m \leq 51$   
 $1 \leq (xL + xH \times 256) \leq 256$  ( $1 \leq xL \leq 128, xH = 0, 1$ )  
 $1 \leq (yL + yH \times 256) \leq 2303$  ( $0 \leq yL \leq 255, 0 \leq yH \leq 8$ )  
 $0 \leq d \leq 255$   
 $k = (xL + xH \times 256) \times (yL + yH \times 256)$

[Default] None

[Printers not featuring this command] **TM-T70, TM-P60, TM-U230, TM-U220**

[Description] Prints a raster bit image using the mode specified by **m**, as follows:

<b>m</b>	<b>Mode</b>	<b>Scaling for horizontal</b>	<b>Scaling for vertical</b>
0, 48	Normal	× 1	× 1
1, 49	Double-width	× 2	× 1
2, 50	Double-height	× 1	× 2
3, 51	Quadruple	× 2	× 2

- **XL, XH** specifies (**XL** + **XH** × 256) bytes in horizontal direction for the bit image.
- **YL, YH** specifies (**YL** + **YH** × 256) dots in vertical direction for the bit image.
- **d** specifies the bit image data (raster format).
- **k** indicates the number of bit image data. **k** is an explanation parameter; therefore, it does not need to be transmitted.

## [Recommended Functions]

This command is supported by only some of the printer models and will not be supported by future models.

It is recommended to use graphics function (**GS ( L GS 8 L**: <Function 50> and <Function 112> ). The graphics function is superior in operating to GS v 0 for the following reasons:

- Selecting a color for printing is possible.
- Size setting in dot unit is possible.

## [Notes]

- When standard mode is selected, this command is enabled only when there is no data in the print buffer and printer is in the beginning of the line. If data exists in the print buffer, the printer processes **m** and the following data as normal data.
- In page mode, the bit image is only stored in the print buffer and is not printed.
- Data (**d**) specifies a bit printed to 1 and not printed to 0.
- If a raster bit image exceeds one line, the excess data is not printed.
- The scales for width and height of raster bit images are specified by **m**. Therefore, in page mode with 90° or 270° clockwise-rotated raster bit image, the printer applies print area and dot density from [width: direction of paper feed, height: perpendicular to direction of paper feed].
- The raster bit image is not affected by print modes (emphasized, double-strike, underline, character size, white/black reverse printing, upside-down printing, or 90° clockwise-rotated).
- This command feeds as much paper as is required to print the raster bit image, regardless of the line spacing specified by **ESC 2** or **ESC 3**.
- If this command is processed while a macro is being defined, the printer cancels macro definition, clears the definition, and prints a raster bit image.

# CONFIDENTIAL

- After printing a raster bit image, the printer processes normal data.  
The print position is set to the left of the print area. Printer is in the beginning of a line and data is not in the print buffer.
- The bit image is printed in the default dot density (dot density of vertical and horizontal direction in normal mode) defined by **GS L** <Function 49>.
- The relationship between bit image data and the print result is as follows:

<b>d1</b>	<b>d2</b>	...	<b>dX</b>
<b>dX + 1</b>	<b>dX + 2</b>	...	<b>dX × 2</b>
⋮	⋮	...	⋮
...	<b>dk-2</b>	<b>dk-1</b>	<b>dk</b>

$$X = (xL + xH \times 256)$$

MSB    LSB    MSB    LSB    MSB    LSB    MSB    LSB

[Model-dependent variations]

**TM-J2000/J2100, TM-T90, TM-T88IV, TM-L90**

## Program Example

```
PRINT #1, CHR$( &H1D ); "v0"; CHR$( 0 );
PRINT #1, CHR$( 16 ); CHR$( 0 ); CHR$( 40 ); CHR$( 0 );
FOR i=1 TO 16*40
  READ a$: d=VAL(" &H"+a$)
  PRINT #1, CHR$( d );
NEXT i

DATA FF,FF,FF,FF,FF,FF,FF,FF,FF,FF,FF,FF,FF,FF,FF,FF
DATA FF,FF,FF,FF,FF,FF,FF,FF,FF,FF,FF,FF,FF,FF,FF,FF
DATA C0,00,00,00,00,00,00,00,00,00,00,00,00,00,00,03
DATA C0,00,00,00,00,00,00,00,00,00,00,00,00,00,00,03
DATA CF,FF,E0,FF,E0,3F,F8,00,5F,FF,80,1F,FC,00,FF,E3
DATA CF,FF,E3,FF,E0,FF,F8,00,5F,FF,E0,7F,FF,03,FF,E3
DATA CF,FF,E7,FF,E1,FF,F8,00,DF,FF,E0,FF,FF,87,FF,E3
DATA CF,FF,E7,FF,E1,FF,F8,00,9F,FF,F0,FF,FF,87,FF,E3
DATA CF,FF,EF,FF,E3,FF,F8,00,9F,FF,F1,FF,FF,CF,FF,E3
DATA CF,FF,EF,FF,E3,FF,F8,01,9F,FF,F1,FF,FF,CF,FF,E3
DATA CF,80,0F,E0,07,F0,00,01,1F,83,F9,F8,0F,CF,E0,03
DATA CF,80,0F,C0,07,F0,00,01,1F,81,F9,F8,0F,CF,C0,03
DATA CF,80,0F,C0,07,E0,00,03,1F,81,FB,F0,07,EF,C0,03
DATA CF,80,0F,C0,07,E0,00,02,1F,81,FB,F0,07,EF,C0,03
DATA CF,80,0F,E0,07,E0,00,06,1F,81,FB,F0,07,EF,E0,03
DATA CF,80,0F,F0,07,E0,00,04,1F,81,FB,F0,07,EF,F0,03
DATA CF,FF,C7,F8,07,E0,00,04,1F,81,FB,F0,07,E7,F8,03
DATA CF,FF,C7,FC,07,E0,00,0C,1F,81,FB,F0,07,E7,FC,03
DATA CF,FF,C3,FE,07,E0,00,08,1F,81,FB,F0,07,E3,FE,03
DATA CF,FF,C1,FF,07,E0,00,18,1F,83,FB,F0,07,E1,FF,03
DATA CF,FF,C0,FF,87,E0,00,18,1F,FF,F3,F0,07,E0,FF,83
DATA CF,FF,C0,7F,C7,E0,00,10,1F,FF,F3,F0,07,E0,7F,C3
```

## Program Example (continued)

```
DATA CF,80,00,3F,E7,E0,00,30,1F,FF,F3,F0,07,E0,3F,E3
DATA CF,80,00,1F,E7,E0,00,20,1F,FF,E3,F0,07,E0,1F,E3
DATA CF,80,00,0F,F7,E0,00,20,1F,FF,E3,F0,07,E0,0F,F3
DATA CF,80,00,07,F7,E0,00,60,1F,FF,83,F0,07,E0,07,F3
DATA CF,80,00,03,F7,E0,00,40,1F,80,03,F0,07,E0,03,F3
DATA CF,80,00,03,F7,E0,00,C0,1F,80,03,F0,07,E0,03,F3
DATA CF,80,00,03,F7,F0,00,80,1F,80,01,F8,0F,C0,03,F3
DATA CF,80,00,07,F7,F0,00,80,1F,80,01,F8,0F,C0,07,F3
DATA CF,FF,EF,FF,F3,FF,F9,80,1F,80,01,FF,FF,CF,FF,F3
DATA CF,FF,EF,FF,F3,FF,F9,00,1F,80,01,FF,FF,CF,FF,F3
DATA CF,FF,EF,FF,F3,FF,F9,00,1F,80,00,FF,FF,8F,FF,F3
DATA CF,FF,EF,FF,E1,FF,FB,00,1F,80,00,FF,FF,8F,FF,F3
DATA CF,FF,EF,FF,C0,FF,FA,00,1F,80,00,7F,FF,0F,FF,C3
DATA CF,FF,EF,FF,00,3F,FA,00,1F,80,00,1F,FC,0F,FF,03
DATA C0,00,00,00,00,00,00,00,00,00,00,00,00,00,00,03
DATA C0,00,00,00,00,00,00,00,00,00,00,00,00,00,00,03
DATA FF,FF,FF,FF,FF,FF,FF,FF,FF,FF,FF,FF,FF,FF,FF,FF
DATA FF,FF,FF,FF,FF,FF,FF,FF,FF,FF,FF,FF,FF,FF,FF,FF
```

## Print Sample

 ← Normal mode

# C O N F I D E N T I A L

**TM-J2000/J2100, TM-T90, TM-T88IV, TM-L90**

This printer supports the graphics functions of **GS ( L/GS 8 L**.

It is recommended to use **GS ( L/GS 8 L** instead of **GS v 0**.

The model information for this function (the dot density and maximum print area and others) is for the graphic functions. See the model information of Function 69 and 112 of **GS ( L/GS 8 L**.



[Name]	Define downloaded bit image
[Format]	ASCII      GS * <b>x y d1 ... d(x × y × 8)</b> Hex        1D 2A <b>x y d1 ... d(x × y × 8)</b> Decimal    29 42 <b>x y d1 ... d(x × y × 8)</b>
[Range]	<b>TM-J2000/J2100:</b> <b>1 ≤ x ≤ 255</b> <b>1 ≤ y ≤ 255 (1 ≤ x × y ≤ 3072)</b> <b>0 ≤ d ≤ 255</b> <b>k = x × y × 8</b>  <b>TM-T90:</b> <b>1 ≤ x ≤ 255 (1 ≤ x × y ≤ 1536)</b> <b>1 ≤ y ≤ 48 (1 ≤ x × y ≤ 1536) [Except for Japanese model]</b> <b>1 ≤ y ≤ 46 (1 ≤ x × y ≤ 1536) [Japanese model]</b> <b>0 ≤ d ≤ 255</b> <b>k = x × y × 8</b>  <b>TM-T88IV, TM-T70:</b> <b>1 ≤ x ≤ 255</b> <b>1 ≤ y ≤ 48 (1 ≤ x × y ≤ 1536)</b> <b>0 ≤ d ≤ 255</b> <b>k = x × y × 8</b>  <b>TM-L90:</b> <b>1 ≤ x ≤ 255</b> <b>1 ≤ y ≤ 46 (1 ≤ x × y ≤ 1536)</b> <b>0 ≤ d ≤ 255</b> <b>k = x × y × 8</b>
[Default]	None
[Printers not featuring this command]	<b>TM-P60, TM-U230, TM-U220</b>
[Description]	Defines the downloaded bit image in the downloaded graphic area. <ul style="list-style-type: none"> <li>• <b>x</b> specifies the number of bytes in horizontal direction as <b>x</b> bytes.</li> <li>• <b>y</b> specifies the number of bytes in vertical direction as <b>y</b> bytes.</li> <li>• <b>d</b> defines the bit image data (column format).</li> </ul>

- **k** indicates the number of the definition data. **k** is an explanation parameter; therefore, it does not need to be transmitted.

## [Recommended Functions]

This command is supported only by some printer models and may not be supported by future models. It is recommended that downloaded graphics function (**GS ( L GS 8 L**: <Function 52 > and <Function 80 > ~ <Function 85>) be used because they offer the following additional features:

- Multiple number of logo data and mark data can be specified (except for some models).
- Data control by key code is possible.
- Redefining or deleting the same data is possible for each key code.
- Selecting a color for printing is possible.
- Defining data by raster format is possible.
- The remaining capacity of the definition area can be confirmed.

## [Notes]

- Data (**d**) specifies a bit printed to 1 and not printed to 0.
- The downloaded bit image is not defined as the default.
- Once a downloaded bit image has been defined, it is available until another definition is made, **ESC @** is executed, the printer is reset, or the power is turned off.
- On some models a downloaded bit image and a user-defined character cannot be defined simultaneously.
  - When this command is executed, the user-defined character is cleared.
  - When **ESC &** is executed, the downloaded bit image data is cleared.
- The downloaded bit image is printed by **GS /**.

■ The relationship between bit image data and print result is as follows.

<b>d1</b>	<b>dy+1</b>	...	:	MSB LSB
<b>d2</b>	<b>dy+2</b>	...	<b>dk-2</b>	MSB LSB
:	:	...	<b>dk-1</b>	MSB LSB
<b>dy</b>	<b>dyx2</b>	...	<b>dk</b>	MSB LSB

See program example and print sample for **GS \*** and **GS /**.

[Model-dependent variations]

**TM-J2000/J2100**, **TM-T90**, **TM-T88IV**, **TM-T70**

## **TM-J2000/J2100**

This printer supports downloaded graphics functions of **GS ( L** and **GS 8 L**. It is recommended that the downloaded graphics function (**GS ( L / GS 8 L**) be used.

A downloaded bit image and a user-defined character cannot be defined simultaneously.

## **TM-T90**

For other than the Japanese model, a downloaded bit image and a user-defined character cannot be defined simultaneously when memory switch 8-7 is ON. See Function 3 of **GS ( E** for the memory switch.

## **TM-T88IV**, **TM-T70**

A downloaded bit image and a user-defined character cannot be defined simultaneously.

## GS /

[Name] Print downloaded bit image

[Format] ASCII GS / **m**  
 Hex 1D 2F **m**  
 Decimal 29 47 **m**

[Range]  $0 \leq m \leq 3, 48 \leq m \leq 51$

[Default] None

[Printers not featuring this command] **TM-P60, TM-U230, TM-U220**

[Description] Prints downloaded bit image using the process of **GS** \* and using the mode specified by **m**, as follows:

<b>m</b>	<b>Mode</b>	<b>Scaling for horizontal</b>	<b>Scaling for vertical</b>
0, 48	Normal	× 1	× 1
1, 49	Double-width	× 2	× 1
2, 50	Double-height	× 1	× 2
3, 51	Quadruple	× 2	× 2

[Recommended Functions]

This command is supported only by some printer models and may not be supported by future models. It is recommended that NV graphics function (**GS ( L GS 8 L**: <Function 52> and <Function 80> ~ <Function 85>) be used because it offers the following additional features:

- Multiple logo data and mark data can be specified. (except for some models)
- Data can be controlled by key code.
- Redefining or deleting the same data is possible for each key code.
- Color can be specified for the definition data.
- Data can be defined by raster format.
- The remaining capacity of definition area can be confirmed.

# CONFIDENTIAL

- [Notes]
- This command is ignored if a downloaded bit image has not been defined.
  - When standard mode is selected, this command is enabled only when there is no data in the print buffer and the printer is in the beginning of the line. If data exists in the print buffer, the printer processes **m** as normal data.
  - When page mode is selected, this command develops the downloaded bit image data in the print buffer but the printer does not print the downloaded bit image data.
  - If a downloaded bit image exceeds one line, the excess data is not printed.
  - The scales for width and height of downloaded bit images are specified by **m**. Therefore, in page mode with 90° or 270° clockwise rotated bit image, the printer applies print area and dot density from [width: direction of paper feed, height: perpendicular to direction of paper feed].
  - The scales for width and height of downloaded bit images are specified by **m**. Therefore, in page mode with 90° or 270° clockwise-rotated bit image, the printer applies print area and dot density from [width: direction of paper feed, height: perpendicular to direction of paper feed].
  - This command feeds as much paper as is required to print the downloaded bit image, regardless of the line spacing specified by **ESC 2** or **ESC 3**.
  - The downloaded bit image is not affected by print mode (emphasized, double-strike, underline, character size, white/black reverse printing, or 90° clockwise-rotated), except for upside-down print mode.
  - When printing a downloaded bit image, selecting unidirectional print mode with **ESC U** enables printing patterns in which the top and bottom parts are aligned vertically.
  - The downloaded bit image is defined by **GS \***.
  - Downloaded bit image is printed in the default dot density (dot density of vertical and horizontal direction in normal mode) defined by **GS L** <Function 49>.
  - After printing the downloaded bit image, the print position is set to the left of the print area. The printer is in the beginning of a line and data is not in the print buffer.

[Model-dependent variations] **TM-J2000/J2100, TM-T90, TM-T88IV, TM-T70, TM-L90**

# CONFIDENTIAL

## Program example for GS \* and GS /

### Program Example

```
PRINT #1, CHR$(&H1D); "*" ; CHR$(18); CHR$(5);
FOR i=1 TO 18*5*8
  READ a$: d=VAL("&H"+a$)
  PRINT #1, CHR$(d);
NEXT i

PRINT #1, CHR$(&H1B); "U"; CHR$(1);
PRINT #1, CHR$(&H1D); "/" ; CHR$(0); CHR$(&HA); ←Normal
PRINT #1, CHR$(&H1D); "/" ; CHR$(1); CHR$(&HA); ←Double width

DATA AA,AA,AA,AA,AA,55,55,55,55,54,80,00,00,00,02
DATA 40,00,00,00,04,80,00,00,00,02,40,00,00,00,04
DATA 8A,AA,AA,AA,A2,45,55,55,55,44,8A,AA,AA,AA,A2
DATA 45,55,55,55,44,8A,AA,AA,AA,A2,45,00,50,01,44
DATA 8A,80,A8,02,A2,45,00,50,01,44,8A,80,A8,02,A2
DATA 45,00,50,01,44,8A,80,A8,02,A2,45,00,50,01,44
DATA 8A,80,A8,02,A2,45,00,00,01,44,8A,80,00,02,A2
DATA 40,00,00,00,04,80,00,00,00,02,40,00,00,00,04
DATA 80,AA,00,02,A2,41,55,00,01,44,82,AA,80,02,A2
DATA 45,55,40,01,44,8A,AA,A0,02,A2,45,45,50,01,44
DATA 8A,82,A8,02,A2,45,01,54,01,44,8A,80,AA,02,A2
DATA 45,00,55,01,44,8A,80,2A,82,A2,45,00,15,55,44
DATA 8A,80,0A,AA,A2,45,00,05,55,44,8A,80,02,AA,82
DATA 40,00,01,55,04,80,00,00,00,02,40,00,00,00,04
DATA 80,00,00,00,02,40,15,55,50,04,80,2A,AA,A8,02
DATA 40,55,55,54,04,80,AA,AA,AA,02,41,55,55,55,04
DATA 82,A8,00,2A,82,45,50,00,15,44,8A,A0,00,0A,A2
DATA 45,40,00,05,44,8A,80,00,02,A2,45,00,00,01,44
DATA 8A,80,00,02,A2,45,00,00,01,44,8A,80,00,02,A2
DATA 45,00,00,01,44,8A,80,00,02,A2,40,00,00,00,04
DATA 80,00,00,00,02,40,00,00,00,04,80,00,00,00,62
DATA 40,00,00,03,84,80,00,00,1C,02,40,00,00,60,04
DATA 80,00,03,80,02,40,00,1C,00,04,80,00,60,00,02
DATA 40,03,80,00,04,80,0C,00,00,02,40,70,00,00,04
```

Define  
downloaded  
bit image

### Program Example (continued)

```
DATA 83,80,00,00,02,4C,00,00,00,04,80,00,00,00,02
DATA 40,00,00,00,04,80,00,00,00,02,4A,AA,AA,AA,A4
DATA 85,55,55,55,42,4A,AA,AA,AA,A4,85,55,55,55,42
DATA 4A,AA,AA,AA,A4,85,00,05,00,02,4A,08,0A,80,04
DATA 85,00,05,00,02,4A,80,0A,80,04,85,00,05,00,02
DATA 4A,80,0A,80,04,85,00,05,00,02,4A,80,0A,80,04
DATA 85,55,55,00,02,42,AA,AA,00,04,81,55,54,00,02
DATA 40,AA,A8,00,04,80,55,50,00,02,40,00,00,00,04
DATA 80,00,00,00,02,40,00,00,00,04,80,2A,AA,A8,02
DATA 40,55,55,54,04,80,AA,AA,AA,02,41,55,55,55,04
DATA 82,AA,AA,AA,82,45,40,00,05,44,8A,80,00,02,A2
DATA 45,00,00,01,44,8A,80,00,02,A2,45,00,00,01,44
DATA 8A,80,00,02,A2,45,00,00,01,44,8A,80,00,02,A2
DATA 45,00,00,01,44,8A,80,00,02,A2,45,40,00,05,44
DATA 82,AA,AA,AA,82,41,55,55,55,04,80,AA,AA,AA,02
DATA 40,55,55,54,04,80,2A,AA,A8,02,40,00,00,00,04
DATA 80,00,00,00,02,40,00,00,00,04,80,AA,00,02,A2
DATA 41,55,00,01,44,82,AA,80,02,A2,45,55,40,01,44
DATA 8A,AA,A0,02,A2,45,45,50,01,44,8A,82,A8,02,A2
DATA 45,01,54,01,44,8A,80,AA,02,A2,45,00,55,01,44
DATA 8A,80,2A,82,A2,45,00,15,55,44,8A,80,0A,AA,A2
DATA 45,00,05,55,44,8A,80,02,AA,82,40,00,01,55,04
DATA 80,00,00,00,02,40,00,00,00,04,80,00,00,00,02
DATA 40,00,00,00,04,AA,AA,AA,AA,AA,55,55,55,55,54
```

### Print Sample



## TM-J2000/J2100

This printer supports the graphics functions of **GS ( L/GS 8 L**. It is recommended to use **GS ( L /GS 8 L** instead of **GS /**.

Values of [Dot Density] and [Maximum Print Area (dot)] are the same as in the graphics function **GS ( L/GS 8 L** of Function 69.

## TM-T90

The dot density and the maximum print area are described in the next tables (dpi: number of dots per 25.4 mm).

“Vertical” is in the direction of paper feeding and “horizontal” is perpendicular (at right angles) to the direction of paper feeding.

The maximum print area in the vertical direction is information used when graphics are printed with the page mode selected (for the starting position specified with **ESC T** is “Upper right” or “Lower left”). In this case, bit images rotated by 90 degrees or 270 degrees are printed.

See Function 5 of **GS ( E** for the paper width.

<Other than Japanese model>

Scaling	Vertical				Horizontal	
	Dot density	Maximum print area (dot)			Dot density	Maximum print area (dot)
		Paper width 80 mm	Paper width 60 mm	Paper width 58 mm		
× 1	180 dpi	512	384	360	180 dpi	831
× 2	90 dpi	256	192	180	90 dpi	415

<Japanese model>

Scaling	Vertical			Horizontal	
	Dot density	Maximum print area (dot)		Dot density	Maximum print area (dot)
		Paper width 80 mm	Paper width 60 / 58 mm		
× 1	203 dpi	576	420	203 dpi	738
× 2	203/2 dpi	288	210	203/2 dpi	369

## TM-L90

The dot density and the maximum print area are described in the next tables (dpi: number of dots per 25.4 mm).

“Vertical” is in the direction of paper feeding and “horizontal” is perpendicular (at right angles) to the direction of paper feeding.

The maximum print area in the vertical direction is information used when graphics are printed with the page mode selected (for the starting position specified with **ESC T** is “Upper right” or “Lower left”). In this case, bit images rotated by 90 degrees or 270 degrees are printed.

See Function 5 of **GS ( E** for the paper width.

See Function 49 of **GS ( E** for the origin of layout (paper layout is not used / top of black mark / bottom of label).

Scaling	Horizontal			Vertical	
	Dot density	Maximum print area (dot)		Dot density	Maximum print area (dot)
		When paper layout is not used or top of black mark is selected	When the bottom of label is selected		
× 1	203 dpi	256 to 576	224 to 560	203 dpi	738
× 2	203/2 dpi	128 to 288	112 to 280	203/2 dpi	369

A horizontal maximum print area is determined according to the width of the paper.

	Paper width	Double density (m = 0,2,48,50)	Single density (m = 1,3,49,51)
When paper layout is not used or top of black mark is selected	80 to 78 mm	576 dot	288 dot
	77 to 38 mm	$(256 + (\text{paper width} - 38) \times 8)$ dot	$(256 + (\text{paper width} - 38) \times 8 / 2)$ dot
When the bottom of label is selected	80 mm	560 dot	280 dot
	79 to 38 mm	$(224 + (\text{paper width} - 38) \times 8)$ dot	$(224 + (\text{paper width} - 38) \times 8 / 2)$ dot



## TM-T88IV

The dot density and the maximum print area are described in the next tables (dpi: number of dots per 25.4 mm).

“Vertical” is in the direction of paper feeding and “horizontal” is perpendicular to the direction of paper feeding.

The maximum print area in the vertical direction is information used when graphics are printed with the page mode selected (for the starting position specified with ESC T is “Upper right” or “Lower left”). In this case, bit images rotated by 90 degrees or 270 degrees are printed.

Scaling	Vertical			Horizontal		
	Dot density	Maximum print area (dot)		Dot density	Maximum print area (dot)	
		Paper width 80 mm	Paper width 58 mm		Single-color printing control	Two-color printing control
× 1	180 dpi	831		180 dpi	1662	360
× 2	90dpi	415		90 dpi	831	180

## TM-T70

The dot density and the maximum print area are described in the next tables (dpi: number of dots per 25.4 mm).

“Vertical” is in the direction of paper feeding and “horizontal” is perpendicular to the direction of paper feeding.

# CONFIDENTIAL

The maximum print area in the vertical direction is information used when graphics are printed with the page mode selected (for the starting position specified with **ESC T** is "Upper right" or "Lower left"). In this case, bit images rotated by 90 degrees or 270 degrees are printed.

Scaling	Vertical				Horizontal		
	Dot density		Maximum print area (dot)		Dot density		Maximum print area (dot)
	Other than Japanese model	Japanese model	Other than Japanese model	Japanese model	Other than Japanese model	Japanese model	
× 1	180 dpi	203 dpi	512	416	180 dpi	203 dpi	1662
× 2	90 dpi	203/2 dpi	256	208	90 dpi	203/2 dpi	831

## GS Q 0

[Name] Print variable vertical size bit image

[Format] ASCII GS Q 0 **m XL xH yL yH d1...dk**  
 Hex 1D 51 30 **m XL xH yL yH d1...dk**  
 Decimal 29 81 48 **m XL xH yL yH d1...dk**

[Printers not featuring this command] **TM-T90, TM-T88IV, TM-T70, TM-L90, TM-P60, TM-U230, TM-U220**

[Range]  $0 \leq m \leq 3, 48 \leq m \leq 51$   
 $1 \leq (XL + xH \times 256) \leq 4256$  ( $0 \leq XL \leq 255, 0 \leq xH \leq 12$ )  
 $1 \leq (yL + yH \times 256) \leq 16$  ( $1 \leq yL \leq 16, yH = 0$ )  
 $0 \leq d \leq 255$   
 $k = (XL + xH \times 256) \times (yL + yH \times 256)$

[Description] Prints a variable vertical size bit image using the mode specified by **m**, as follows:

<b>m</b>	<b>Mode</b>	<b>Scaling for horizontal</b>	<b>Scaling for vertical</b>
0, 48	Normal	× 1	× 1
1, 49	Double-width	× 2	× 1
2, 50	Double-height	× 1	× 2
3, 51	Quadruple	× 2	× 2

- **XL, xH** specifies  $(XL + xH \times 256)$  dots in horizontal direction for the bit image.
- **yL, yH** specifies  $(yL + yH \times 256)$  bytes in vertical direction for the bit image.
- **d** specifies the bit image data (column format).
- **k** indicates the number of the bit image data. **k** is an explanation parameter; therefore, it does not need to be transmitted.

## [Recommended Functions]

This command is supported only by some printer models and may not be supported by future models.

It is recommended to use graphics function (**GS ( L GS 8 L**: <Function 50> and <Function 113>). The graphics functions are better than **GS Q 0** for the following reasons:

- Selecting a color for printing is possible.
- Selecting a size in dot units is possible.

## [Notes]

- In standard mode, this command is effective only when data is not in the print buffer and the printer is at the beginning of the line.
- This command processes **k** bytes data of **d1...dk** as a bit image data. Image data (**d**) specifies a bit printed to 1 and not printed to 0.
- If a variable vertical bit image that exceeds the print area for a line is specified, the excess image data is ignored.
- The scales for width and height of NV bit images are specified by **m**. Therefore, in page mode with 90° or 270° clockwise-rotated NV bit image, the printer applies print area and dot density from [width: direction of paper feed, height: perpendicular to direction of paper feed].
- Character size and all print modes such as emphasize, underline, 90° clockwise rotation, or upside-down, do not affect printing of a variable vertical size bit image data.
- This command feeds paper for the amount needed for printing a variable vertical bit image regardless of the paper feed setting set by paper feed setting commands.
- Do not use this command during macro execution because the command cannot be included in a macro.
- After printing a variable vertical bit-image, normal data processing is started.  
The print position is set to the left of the print area. The printer is at the beginning of a line and data is not in the print buffer.

■ Relationship between bit-image data and printing result is as follows:

<b>d1</b>	<b>dy + 1</b>	...	<b>:</b>	MSB
<b>d2</b>	<b>dy + 2</b>	...	<b>dk - 2</b>	LSB
<b>:</b>	<b>:</b>	...	<b>dk - 1</b>	MSB
<b>dy</b>	<b>dy × 2</b>	...	<b>dk</b>	LSB

$$Y = (y_L + y_H \times 256)$$

[Model-dependent variations] **TM-J2000/J2100**

## TM-J2000/J2100

This printer supports the graphics functions of **GS ( L/GS 8 L**. It is recommended to use **GS ( L /GS 8 L** instead of **GS Q 0**.

The model information for this function (the dot density and maximum print area and others) is for the graphic functions. See the model information of Function 69 and 113 of **GS ( L/GS 8 L**.

## Program Example for GS Q 0

### Program Example

```
PRINT #1, CHR$( &H1B); "U"; CHR$(1); ←Specify unidirection
PRINT #1, CHR$( &H1D); "p"; CHR$(0);
PRINT #1, CHR$(144); CHR$(0); CHR$(5); CHR$(0);
FOR i=1 TO 144*5
  READ a$: d=VAL(" &H"+a$)
  PRINT #1, CHR$(d);
NEXT i
```

Definition

```
PRINT #1, CHR$( &H1B); "U"; CHR$(1); ←Select direction
PRINT #1, CHR$( &H1C); "p"; CHR$(0); CHR$( &HA); ←Normal
PRINT #1, CHR$( &H1C); "p"; CHR$(1); CHR$( &HA); ←Double width
```

```
DATA AA,AA,AA,AA,AA,55,55,55,55,54,80,00,00,00,02
DATA 40,00,00,00,04,80,00,00,00,02,40,00,00,00,04
DATA 8A,AA,AA,AA,A2,45,55,55,55,44,8A,AA,AA,AA,A2
DATA 45,55,55,55,44,8A,AA,AA,AA,A2,45,00,50,01,44
DATA 8A,80,A8,02,A2,45,00,50,01,44,8A,80,A8,02,A2
DATA 45,00,50,01,44,8A,80,A8,02,A2,45,00,50,01,44
DATA 8A,80,A8,02,A2,45,00,00,01,44,8A,80,00,02,A2
DATA 40,00,00,00,04,80,00,00,00,02,40,00,00,00,04
DATA 80,AA,00,02,A2,41,55,00,01,44,82,AA,80,02,A2
DATA 45,55,40,01,44,8A,AA,A0,02,A2,45,45,50,01,44
DATA 8A,82,A8,02,A2,45,01,54,01,44,8A,80,AA,02,A2
DATA 45,00,55,01,44,8A,80,2A,82,A2,45,00,15,55,44
DATA 8A,80,0A,AA,A2,45,00,05,55,44,8A,80,02,AA,82
DATA 40,00,01,55,04,80,00,00,00,02,40,00,00,00,04
DATA 80,00,00,00,02,40,15,55,50,04,80,2A,AA,A8,02
DATA 40,55,55,54,04,80,AA,AA,AA,02,41,55,55,55,04
DATA 82,A8,00,2A,82,45,50,00,15,44,8A,A0,00,0A,A2
DATA 45,40,00,05,44,8A,80,00,02,A2,45,00,00,01,44
DATA 8A,80,00,02,A2,45,00,00,01,44,8A,80,00,02,A2
DATA 45,00,00,01,44,8A,80,00,02,A2,40,00,00,00,04
DATA 80,00,00,00,02,40,00,00,00,04,80,00,00,00,62
DATA 40,00,00,03,84,80,00,00,1C,02,40,00,00,60,04
DATA 80,00,03,80,02,40,00,1C,00,04,80,00,60,00,02
DATA 40,03,80,00,04,80,0C,00,00,02,40,70,00,00,04
```

### Program Example (continued)

```
DATA 83,80,00,00,02,4C,00,00,00,04,80,00,00,00,02
DATA 40,00,00,00,04,80,00,00,00,02,4A,AA,AA,AA,A4
DATA 85,55,55,55,42,4A,AA,AA,AA,A4,85,55,55,55,42
DATA 4A,AA,AA,AA,A4,85,00,05,00,02,4A,08,0A,80,04
DATA 85,00,05,00,02,4A,80,0A,80,04,85,00,05,00,02
DATA 4A,80,0A,80,04,85,00,05,00,02,4A,80,0A,80,04
DATA 85,55,55,00,02,42,AA,AA,00,04,81,55,54,00,02
DATA 40,AA,A8,00,04,80,55,50,00,02,40,00,00,00,04
DATA 80,00,00,00,02,40,00,00,00,04,80,2A,AA,A8,02
DATA 40,55,55,54,04,80,AA,AA,AA,02,41,55,55,55,04
DATA 82,AA,AA,AA,82,45,40,00,05,44,8A,80,00,02,A2
DATA 45,00,00,01,44,8A,80,00,02,A2,45,00,00,01,44
DATA 8A,80,00,02,A2,45,00,00,01,44,8A,80,00,02,A2
DATA 45,00,00,01,44,8A,80,00,02,A2,45,40,00,05,44
DATA 82,AA,AA,AA,82,41,55,55,55,04,80,AA,AA,AA,02
DATA 40,55,55,54,04,80,2A,AA,A8,02,40,00,00,00,04
DATA 80,00,00,00,02,40,00,00,00,04,80,AA,00,02,A2
DATA 41,55,00,01,44,82,AA,80,02,A2,45,55,40,01,44
DATA 8A,AA,A0,02,A2,45,45,50,01,44,8A,82,A8,02,A2
DATA 45,01,54,01,44,8A,80,AA,02,A2,45,00,55,01,44
DATA 8A,80,2A,82,A2,45,00,15,55,44,8A,80,0A,AA,A2
DATA 45,00,05,55,44,8A,80,02,AA,82,40,00,01,55,04
DATA 80,00,00,00,02,40,00,00,00,04,80,00,00,00,02
DATA 40,00,00,00,04,AA,AA,AA,AA,AA,55,55,55,55,54
```

### Print Sample



## STATUS COMMANDS

Command	Name
---------	------

<b>DLE EOT</b>	Transmit real-time status
<b>ESC u</b>	Transmit peripheral device status
<b>ESC v</b>	Transmit paper sensor status
<b>GS a</b>	Enable/disable Automatic Status Back (ASB)
<b>GS j</b>	Enable/disable Automatic Status Back (ASB) for ink
<b>GS r</b>	Transmit status

## DLE EOT

[Name] Transmit real-time status

[Format] ASCII DLE EOT **n** [**a**]  
 Hex 10 04 **n** [**a**]  
 Decimal 16 4 **n** [**a**]

[Printers not featuring this command] None

[Range] **TM-J2000/J2100:**  $1 \leq n \leq 4, n = 7$   
 $a = 1, 2$  [When  $n = 7$ ]  
**TM-T90, TM-T88IV, TM-T70, TM-P60, TM-U230, TM-U220 :**  $1 \leq n \leq 4, n = 7$   
**TM-L90:**  $1 \leq n \leq 4, n = 8, a = 3$  (when  $n = 8$ ) (TM-L90 with Peeler)  
 $1 \leq n \leq 4$  (TM-L90 without Peeler)  
**TM-P60:**  $1 \leq n \leq 4, n = 8, a = 3$  (when  $n = 8$ ) (TM-P60 with Peeler)  
 $1 \leq n \leq 4$  (TM-P60 without Peeler)

[Description] Transmits the real-time status, using **n** as follows:

<b>n</b>	<b>a</b>	<b>Function</b>
1	--	Transmit printer status
2	--	Transmit offline status
3	--	Transmit error status
4	--	Transmit roll paper sensor status
7	1	Transmit ink status A
	2	Transmit ink status B
8	3	Transmit peeler status

Omit the parameter **a** when ( $1 \leq n \leq 4$ )  
 Transmit the parameter **a** when ( $n = 7$ )

**DLE EOT BEL** is **DLE EOT (n=7)**; for some previous printer models this command is called **DLE EOT BEL**.



[Notes]

- This is a real-time command that the printer executes upon receiving it. Take the following into consideration:
  - If this command interrupts the code string of another command, this command is processed as a parameter of the other command; therefore, the print result will not be correct.
  - If a command such as graphics data or defined data has a code string that is the same as a code string in a parameter, the printer processes and then continues with the bit-image or other command.
- With a serial interface model, this command is executed even when the printer is offline, the receive buffer is full, or an error occurs.
- With a parallel interface model, this command is not executed in the following conditions, because the printer is busy and unable to receive data from the host computer. The DIP switch (BUSY condition) is different, depending on the printer model.
  - Receive buffer is full when DIP switch or memory switch (BUSY condition) is set to On.
  - Printer is offline, an error occurs, or receive buffer is full when DIP switch or memory switch (BUSY condition) is set to Off.
- This command can be used when the printer is disabled by **ESC =**.
- This command is ignored when transmitting block data (Header ~ NUL).
- Each status equals 1 byte.

■ Printer status (n = 1) is as follows:

Bit	Binary	Hex	Decimal	Status
0	0	00	0	Not used. Fixed to Off.
1	1	02	2	Not used. Fixed to On.
2	0	00	0	Drawer kick-out connector pin 3 is LOW.
	1	04	4	Drawer kick-out connector pin 3 is HIGH.
3	0	00	0	Online.
	1	08	8	Offline.
4	1	10	16	Not used. Fixed to On.
5	0	00	0	Not waiting for online recovery.
	1	20	32	Waiting for online recovery.
6	0	00	0	Paper is not being fed by the paper feed button.
	1	04	64	Paper is being fed by the paper feed button.
7	0	00	0	Not used. Fixed to Off.

... how to use  
this table

Online recovery wait (bit 5) is changed when **GS ^** or **GS FF** is executed or the printer is waiting for the paper feed button to be pressed for removing a label or for roll paper to be replaced for some models.

■ Offline status A (n = 2) is as follows:

Bit	Binary	Hex	Decimal	Status
0	0	00	0	Not used. Fixed to Off.
1	1	02	2	Not used. Fixed to On.
2	0	00	0	Cover is closed.
	1	04	4	Cover is open.
3	0	00	0	Paper is not being fed by the paper feed button.
	1	08	8	Paper is being fed by the paper feed button.
4	1	10	16	Not used. Fixed to On.
5	0	00	0	No paper-end stop.
	1	20	32	Printing stops due to a paper-end.
6	0	00	0	No error.
	1	40	64	Error occurred.
7	0	00	0	Not used. Fixed to Off.

... how to use  
this table

- Error status (**n** = 3) is as follows:

Bit	Binary	Hex	Decimal	Status
0	0	00	0	Not used. Fixed to Off.
1	1	02	2	Not used. Fixed to On.
2	0	00	0	No recoverable error.
	1	04	4	Recoverable error occurred.
3	0	00	0	No autocutter error.
	1	08	8	Autocutter error occurred.
4	1	10	16	Not used. Fixed to On.
5	0	00	0	No unrecoverable error.
	1	20	32	Unrecoverable error occurred.
6	0	00	0	No auto-recoverable error.
	1	40	64	Auto-recoverable error occurred.
7	0	00	0	Not used. Fixed to Off.

... *how to use  
this table*

- If recoverable error (bit 2) or autocutter error (bit 3) occurs due to paper jams or the like, it is possible to recover by correcting the cause of the error and executing **DLE ENQ (n = 2)**.
- If an unrecoverable error (bit 5) occurs, turn off the power as soon as possible.
- The cause of the error can be checked by the offline response (when an offline cause is added). See Function 49 of GS ( H).

- Roll paper sensor status ( $n = 4$ ) is as follows:

Bit	Off/On	Hex	Decimal	Status
0	0	00	0	Not used. Fixed to Off.
1	1	02	2	Not used. Fixed to On.
2, 3	00	00	0	Roll paper near-end sensor: paper adequate.
	11	0C	12	Roll paper near-end sensor: paper near end.
4	1	10	16	Not used. Fixed to On.
5, 6	00	00	0	Roll paper end sensor: paper present.
	11	60	96	Roll paper end sensor: paper not present.
7	0	00	0	Not used. Fixed to Off.

*... how to use  
this table*

- Some paper sensors are not present, depending on the printer model. The names of some paper sensors are different, depending on the printer model.

■ Ink status A (**n** = 7, **a** = 1) is as follows:

Bit	Function	Binary	Hexadecimal	Decimal
0	Fixed	0	00	0
1	Fixed	1	02	2
2	No ink near-end detected (1st color)	0	00	0
	Ink near-end detected (1st color)	1	04	4
3	No ink end detected (1st color)	0	00	0
	Ink end detected (1st color)	1	08	8
4	Fixed	1	10	16
5	Ink cartridge detected (1st color)	0	00	0
	Ink cartridge not detected (1st color)	1	20	32
6	Cleaning is not being performed	0	00	0
	Cleaning is being performed	1	40	64
7	Fixed	0	00	0

■ Ink status B (**n** = 7, **a** = 2) is as follows:

Bit	Function	Binary	Hexadecimal	Decimal
0	Fixed	0	00	0
1	Fixed	1	02	2
2	No ink near-end detected (2nd color)	0	00	0
	Ink near-end detected (2nd color)	1	04	4
3	No ink end detected (2nd color)	0	00	0
	Ink end detected (2nd color)	1	08	8
4	Fixed	1	10	16
5	Ink cartridge detected (2nd color)	0	00	0
	Ink cartridge not detected (2nd color)	1	20	32
6	Reserved	-	-	-
7	Fixed	0	00	0

■ Ink status B (**n** = 8, **a** = 3) is as follows:

Bit	Function	Binary	Hexadecimal	Decimal
0	Fixed	0	00	0
1	Fixed	1	02	2
2	Not waiting for a label to be removed	0	00	0
	Waiting for a label to be removed	1	04	4
3	Reserved	-	-	-
4	Fixed	1	10	16
5	Paper present in label peeling detector	0	00	0
	No paper present in label peeling detector	1	20	32
6	Reserved	-	-	-
7	Fixed	0	00	0

■ When you use this command, follow these rules.

- After the host PC transmits the function data, the printer will send response data or status data back to the PC. Do not transmit more data from the PC until the real-time status data are received from the printer.
- Only when it is necessary to acquire plural, real-time status items continuously, up to the limitation of the printer model, this command can be transmitted continuously. However, the next data is not transmitted until all status items are received in this case.
- With serial interface, use this command when the printer is in Ready status.
- With a parallel interface, a real-time status is stored in the transmission buffer of the printer temporarily the same as the other transmission data (except for ASB status), and when the host enters Reverse Mode, data is transmitted in order from the beginning of the transmission buffer. The



transmission buffer is 99 bytes; therefore, data that exceeds 99 bytes is ignored. When using this command, the host should be changed to the Reverse Mode immediately and execute a receive processing of status.

- Real time status can be differentiated by the information of bits 0, 1, 4, and 7 from other transmission data. If the data transmitted from the printer after outputting is "0xx1xx10"(x = 0 or 1), process the data as a real time status.

[Model-dependent variations]

**TM-J2000/J2100, TM-T90, TM-T88IV, TM-T70, TM-L90, TM-P60, TM-U230, TM-U220**

### Program Example for all printers

```
PRINT #1, CHR$(&h10);CHR$(&h4);CHR$(2); ←Transmits offline status
```

```
PRINT #1, CHR$(&h10);CHR$(&h4);CHR$(&h7);CHR$(1); ←Transmits ink status A
```

## TM-J2000/J2100

**BUSY condition for a parallel interface is selected by memory switch 1-3.**

**Use this command according to the following rules; otherwise, the status might not be transmitted.**

- **The next data is not transmitted until status is received after this command is transmitted.**
- **Only when it is necessary to acquire plural, real-time status items continuously, this command can be transmitted continuously up to 6 times. However, the next data is not transmitted until all status is received in this case.**

■ **Roll paper sensor status (n = 4)**

**When the cover is open, the status of the roll paper end sensor (bit 5, 6) retain the value when the cover was closed immediately before.**

■ **Ink status A / B (n = 7)**

# CONFIDENTIAL

When an ink near-end is detected, the INK OUT light blinks. It is possible to print approximately 20,000 characters using Font B with print control mode = economy printing specified from the time an ink near-end is detected until an ink end is detected. However, the value is only a reference value, it depends on environmental factors such as printing data, and the timing of head cleaning. Therefore, replace an old ink cartridge with a new one when a ink near-end is detected.

**TM-J2000** (single-color) does not support ink status B (n = 7, a = 2).

Two ink cartridges combined are installed in the **TM-J2100** (two-color), and the presence of the cartridge is detected with one detector. Therefore, both of the following status items are the same.

Bit 5 of Ink Status A

Bit 5 of Ink Status B

## TM-T90

BUSY condition for a parallel interface is selected by memory switch 1-3.

■ Roll paper sensor status (n = 4)

When the cover is open, the status of the roll paper end sensor (bit 5, 6) retain the value when the cover was closed immediately before.

## TM-L90

**TM-L90 with Peeler**

BUSY condition for a parallel interface is selected by memory switch 1-3.

The peeling issuing mode or the continuous issuing mode (not using peeler) can be selected by a switch on the printer. This is a slide switch that can be used when the roll paper cover is open.

■ Printer cause status (n = 1)

Online recovery wait (bit 5) is changed when **GS ^** is executed or the printer is in one of the following status conditions when the peeling issuing mode is selected.

Waiting for the FEED button to be pressed with the cover closed.

Waiting for the FEED button to be pressed when removing a label (when the peeling detector cannot detect a label due to sunlight)

■ Error cause status (n = 3)

If the cause of the recoverable error (bit 2) is a paper layout error, the printer can recover from the error by opening/closing the roll paper cover or by the **DLE ENQ** command, or pressing the paper feed button only when memory switch Msw 8-1 or Msw 8-2 is OFF. See Function 3 of **GS E**.

Bit 3 is not supported.

■ Continuous paper detection status (n = 4)

When the cover is open, the status of the roll paper end sensor (bit 5, 6) retain the value when the cover was closed immediately before.

■ Peeler status (n = 8, a = 3)

Bit 0: When the continuous issuing mode is selected, this bit is always 0.

Bit 2: When the peeling issuing mode is selected, this bit is changed during paper feeding or when a label is in the peeling position. When label removal is checked by pressing the paper feed button, this bit may be incorrect. When the continuous issuing mode is selected, this bit is always 1.

Models other than the **TM-L90** with Peeler

The default value is set by Msw 1-3.

■ Error cause status (n = 3)

If the cause of the recoverable error (bit 2) is a paper layout error, the printer can recover from the error by opening/closing the roll paper cover or by the **DLE ENQ** command, or pressing the paper feed button only when memory switch Msw 8-2 is OFF. See Function 3 of **GS E**.

■ Continuous paper detection status (n = 4)

When the cover is open, the status of the roll paper end sensor (bit 5, 6) retain the value when the cover was closed immediately before.

## TM-T88IV

**BUSY condition for a parallel interface is selected by DIP switch 2-1.**

■ **Printer status (n = 1)**

**Bits 5 and 6 of the printer status are undefined.**

■ **Error status (n = 3)**

**Bit 2 of the error status is undefined.**

■ **Roll paper sensor status (n = 4)**

**When the cover is open, the status of the roll paper end sensor (bit 5, 6) retain the value when the cover was closed immediately before.**

## TM-T70

**BUSY condition for a parallel interface is selected by DIP switch 2-1.**

■ **Printer status (n = 1)**

**Bits 5 and 6 of the printer status are undefined.**

■ **Error status (n = 3)**

**Bit 2 of the error status is undefined.**

■ **Roll paper sensor status (n = 4)**

**When the cover is open, the states of the roll paper near end sensor (bit 2, 3) and the roll paper end sensor (bit 5, 6) retain the values when the cover was closed immediately before.**

## TM-P60

### **TM-P60 with Peeler**

**Use this command according to the following rule; otherwise, the status might not be transmitted.**

**The next data is not transmitted until the status is received when this command is transmitted.**

# CONFIDENTIAL

Only when it is necessary to acquire plural real-time status items continuously, this command can be transmitted continuously up to 5 times. However, the next data is not transmitted until all status items are received in this case.

## ■ Printer status (n = 1)

Bit 2 status is as follows:

n: Bit	Binary	Hex	Decimal	Function
2	0	00	0	Does not go offline by low battery.
	1	04	4	Offline by low battery.

*... how to use  
this table*

Bit 5 of the printer status is not supported.

## ■ Offline cause status (when n = 2 is specified)

Bit 2 indicates the open/closed status of the peeler cover.

## ■ Error cause status (n = 3)

Bit 3 of the error cause status is not supported.

If the cause of an automatically recoverable error (bit 6) is a "paper error," recovery from the error is possible by opening and closing the peeler cover.

## ■ Roll paper sensor status (n = 4)

Bits 2 and 3 of the roll paper sensor status are not supported.

When the cover is open, the status of the roll paper end sensor (bit 5, 6) retain the value when the cover was closed immediately before.

## ■ Peeler status (n = 8, a = 3)

Bit 0: When the continuous issuing mode is selected, this bit is always 0.

**Bit 2:** When the peeling issuing mode is selected, this bit is changed during paper feeding or when a label is in the peeling position. When the continuous issuing mode is selected, this bit is always 1.

The peeling issuing mode/continuous issuing mode is selected with the operation shown below.

### Selecting the peeling issuing mode

Step	Operation
1	Press the cover open button, and open the peeler cover.
2	If the paper roll cover was open in Step 1, close the paper roll cover.
3	Press the peeler changeover lever. The peeler holder is raised.
4	Close the peeler cover.

### Selecting the continuous issuing mode

Step	Operation
1	Press the cover open button, and open the peeler cover.
2	If the paper roll cover was open in Step 1, close the paper roll cover.
3	Fold up the peeler holder.
4	Close the peeler cover.

### TM-P60 other than Peeler

Use this command according to the following rule; otherwise, the status might not be transmitted.

The next data is not transmitted until the status is received when this command is transmitted.

Only when it is necessary to acquire plural real-time status items continuously, this command can be transmitted continuously up to 5 times. However, the next data is not transmitted until all status items are received in this case.

#### ■ Printer status (n = 1)

Bit 2 status is as follows:

n: Bit	Binary	Hex	Decimal	Function
2	0	00	0	Does not go offline by low battery.
	1	04	4	Offline by low battery.

Bit 5 of the printer status is not supported.

■ Error cause status (n = 3)

Bit 2 of the error cause status is not supported.

■ Roll paper sensor status (n = 4)

Bits 2 and 3 of the roll paper sensor status are not supported.

When the cover is open, the status of the roll paper end sensor (bit 5, 6) retain the value when the cover was closed immediately before.

## TM-U230

BUSY condition for a parallel interface is selected by DIP switch 1-8.

■ Printer status (n = 1)

Bit 6 of the printer status is undefined.

## TM-U220

BUSY condition for a parallel interface is selected by DIP switch 1-8.

This printer can send this command continuously up to 8 times.

■ Printer status (n = 1)

Bit 5, and 6 of the printer status is undefined.

■ Roll paper sensor status (n = 4)

# C O N F I D E N T I A L

**The roll paper near-end sensor is an option. If the printer is not equipped with the paper near-end sensor, bits 2 and 3 of the third byte are always ON, "Paper adequate."**

**When the cover is open, the status of the roll paper end sensor (bit 5, 6) retain the value when the cover was closed immediately before.**



## ESC u

[Name] Transmit peripheral device status

[Format] ASCII ESC u **n**  
 Hex 1B 75 **n**  
 Decimal 27 117 **n**

[Range] **n** = 0, 48

[Printers not featuring this command] **TM-J2000/J2100, TM-T90, TM-T70, TM-L90, TM-P60, TM-U230**

[Description] Transmits the peripheral device status as 1 byte of data.

[Recommended Functions]

This command is supported only by some printer models but will not be supported by future models. It is recommended to use **GS r 2** to check the status and **GS r** to transmit the peripheral device status.

[Notes] ■ **ESC u** is not a recommended command. **ESC u** will not be included in future products.

■ The peripheral device status to be transmitted is as follows:

Bit	Binary	Hex	Decimal	Status
0	0	00	0	Drawer kick-out connector pin 3 is LOW.
	1	01	1	Drawer kick-out connector pin 3 is HIGH.
1-3	—	—	—	Undefined.
4	0	00	0	Not used. Fixed to Off.
5, 6	—	—	—	Undefined.
7	0	00	0	Not used. Fixed to Off.

... *how to use this table*

[Model-dependent variations] None

### Program Example for all printers

```
PRINT #1,CHR$( &h1B ); "u";CHR$( 0 );
```

## ESC v

[Name] Transmit paper sensor status

[Format] ASCII ESC v  
 Hex 1B 76  
 Decimal 27 118

[Printers not featuring this command] **TM-J2000/J2100, TM-T90, TM-T70, TM-L90, TM-P60, TM-U230**

[Description] Transmits the status of paper sensor(s) as 1 byte of data.

[Recommended Functions]

This command is supported only by some printer models but will not be supported by future models. It is recommended to use **GS r 1** to check the status and **GS r** for transmitting the paper sensor status.

[Notes] ■ See **GS r** for details on status transmission.

■ The peripheral device status to be transmitted is as follows:

Bit	Binary	Hex	Decimal	Status
0, 1	00	00	0	Roll paper near-end sensor: paper adequate.
	11	03	3	Roll paper near-end sensor: paper near end.
2, 3	00	00	0	Roll paper end sensor: paper present.
	11	0C	12	Roll paper end sensor: paper not present.
4	0	00	0	Not used. Fixed to Off.
5, 6	—	—	—	Undefined.
7	Off	00	0	Not used. Fixed to Off.

*... how to use this table*

[Model-dependent variations] **TM-T88IV, TM-U220**

**Program Example for all printers**

```
PRINT #1,CHR$(&h1B);"v";
```

## **TM-T88IV**

**When the roll paper end sensor detects a paper-end, the printer goes offline and does not execute this command. Therefore, bits 2 and 3 of the paper sensor status do not transmit a paper-end status.**

## **TM-U220**

**The roll paper near-end sensor is an option. If the printer is not equipped with the paper near-end sensor, bits 0 and 1 of the third byte are always ON, "Paper adequate."**

**When the roll paper end sensor detects a paper-end, the printer goes offline and does not execute this command. Therefore, bits 2 and 3 of the paper sensor status do not transmit a paper-end status.**

## GS a

[Name] Enable/disable Automatic Status Back (ASB)

[Format] ASCII GS a **n**  
 Hex 1D 61 **n**  
 Decimal 29 97 **n**

[Range]  $0 \leq n \leq 255$

[Default] **TM-J2000/J2100, TM-T90, TM-T88IV, TM-T70, TM-L90, TM-U230, TM-U220:**  
 When DIP switch or memory switch (BUSY condition) is Off: **n = 0**  
 When DIP switch or memory switch (BUSY condition) is On: **n = 2**  
**TM-P60: n = 255**

[Printers not featuring this command] None

[Description] Enables or disables basic ASB (Automatic Status Back) and specifies the status items to include, using **n** as follows:

<b>n:</b> <b>Bit</b>	<b>Binary</b>	<b>Hex</b>	<b>Decimal</b>	<b>Function</b>
0	0	00	0	Drawer kick-out connector status disabled.
	1	01	1	Drawer kick-out connector status enabled.
1	0	00	0	Online/offline status disabled.
	1	02	2	Online/offline status enabled.
2	0	00	0	Error status disabled.
	1	04	4	Error status enabled.
3	0	00	0	Roll paper sensor status disabled.
	1	08	8	Roll paper sensor status enabled.
4,5	0	00	0	Undefined.

*... how to use  
this table*

n: Bit	Binary	Hex	Decimal	Function
6	0	00	0	Panel switch status disabled.
	1	40	64	Panel switch status enabled.
7	0	00	0	Undefined.

[Notes]

- ASB is the function that transmit the status of [cover open/close], [Online/Offline] from the printer automatically. It is called [ASB function] and the status is [ASB status]. If you use ASB, application can acquire the printer change in a real-time and passively.
- Select any status enabled (except **n** = 0) and basic ASB starts. Then transmit the current basic ASB status. After that, while ASB is active the selected enabled basic ASB status is transmitted whenever the status changes.
- When **n** = 0, basic ASB is disabled. When ASB is disabled, basic ASB status is not transmitted.
- Multiple status items can be selected.
- When ASB is active, ASB status is transmitted whenever the status changes even if the printer is disabled by **ESC =**.
- This command setting is effective until **ESC @** is executed, the printer is reset or power is turned off.
- Any basic ASB status represents the enabled status whenever the status changes. Therefore the disabled status items may change, because each status transmission represents the current status.

■ The basic ASB statuses, corresponding to each bit for **n** are as follows:

<b>n</b>		<b>ASB status</b>	
<b>Bit</b>	<b>Function</b>	<b>Bit</b>	<b>Status</b>
0	Drawer kick-out connector status.	Bit 2 of the first byte	Drawer kick-out connector pin 3 status.
1	Online/offline status.	Bit 3 of the first byte	Online/ offline status.
		Bit 5 of the first byte	Cover status.
		Bit 6 of the first byte	Paper is being fed by paper feed button status.
		Bit 0 of the second byte	Waiting for online recovery status.
		Bit 0 and 1 of the third byte [Note]	Roll paper near-end sensor status.
		Bit 2 and 3 of the third byte [Note]	Roll paper end sensor status.
2	Error status.	Bit 2 of the second byte	Recoverable error status.
		Bit 3 of the second byte	Autocutter error status.
		Bit 5 of the second byte	Unrecoverable error status.
		Bit 6 of the second byte	Automatically recoverable error status.
3	Roll paper sensor status.	Bits 0 and 1 of the third byte	Roll paper near-end sensor status.
		Bits 2 and 3 of the third byte	Roll paper end sensor status.
6	Panel switch status.	Bit 1 of the second byte	Paper feed status

*... how to use this table*

[Note] Only if **ESC 4** is selected or paper stop printing sensor is not selected.

- Basic ASB status is 4-byte configuration [first byte - fourth byte].
- The status to be transmitted are as follows:
- First byte (printer information)

Bit	Binary	Hex	Decimal	Status for ASB
0	0	00	0	Not used. Fixed to Off.
1	0	00	0	Not used. Fixed to Off.
2	0	00	0	Drawer kick-out connector pin 3 is LOW.
	1	04	4	Drawer kick-out connector pin 3 is HIGH.
3	0	00	0	Online.
	1	08	8	Offline.
4	1	10	16	Not used. Fixed to On.
5	0	00	0	Cover is closed.
	1	20	32	Cover is open.
6	0	00	0	Paper is not being fed by the paper feed button.
	1	40	64	Paper is being fed by the paper feed button.
7	0	00	0	Not used. Fixed to Off.

*... how to use  
this table*

- Second byte (printer information)

Bit	Binary	Hex	Decimal	Status for ASB
0	0	00	0	Not waiting for online recovery.
	1	01	1	Waiting for online recovery.
1	0	00	0	Paper feed button is not pushed (off)
	1	02	2	Paper feed button is pushed (on)

*... how to use  
this table*

Bit	Binary	Hex	Decimal	Status for ASB
2	0	00	0	No recoverable error (except for autocutter error).
	1	04	4	Recoverable error occurred (except for autocutter error).
3	0	00	0	No autocutter error.
	1	08	8	Autocutter error occurred.
4	0	00	0	Not used. Fixed to Off.
5	0	00	0	No unrecoverable error.
	1	20	32	Unrecoverable error occurred.
6	0	00	0	No automatically recoverable error.
	1	40	64	Automatically recoverable error occurred.
7	0	00	0	Not used. Fixed to Off.

- Online recovery wait (bit 0) is changed when **GS ^** or **GS FF** is executed, the printer waits for the button to be pressed for removing a label, or roll paper to be replaced for some models.
- If recoverable error (bit 2) or autocutter error (bit 3) occurs due to paper jams or the like, it is possible to recover by correcting the cause of the error and executing **DLE ENQ (n = 2)**.
- If an unrecoverable error (bit 5) occurs, turn off the power as soon as possible.
- The cause of the error can be checked by the offline response (when an offline cause is added). See Function 49 of **GS (H)**.



■ Third byte (paper sensor information)

Bit	Binary	Hex	Decimal	Status for ASB
0, 1	00	00	0	Roll paper near-end sensor: paper adequate.
	11	03	3	Roll paper near-end sensor: paper near end.
2, 3	00	00	0	Roll paper end sensor: paper present.
	11	0C	12	Roll paper end sensor: paper not present.
4	0	00	0	Not used. Fixed to Off.
5,6	—	—	—	Undefined
7	0	00	0	Not used. Fixed to Off.

... how to use  
this table

- Some paper sensors are not present, depending on the printer model. The names of some paper sensors are different, depending on the printer model.

■ Fourth byte (paper sensor information)

Bit	Binary	Hex	Decimal	Status for ASB
0-3	—	—	—	Undefined
4	0	00	0	Not used. Fixed to Off.
5,6	—	—	—	Undefined
7	0	00	0	Not used. Fixed to Off.

... how to use  
this table

- During Block data [header - NUL] transmission, ASB is disabled temporarily. Therefore you cannot get the printer status change through ASB status when block data [header - NUL] is transmitted.
- With a serial interface, the printer transmits a 4-byte ASB status message without confirming whether the host can receive data.
- With a parallel interface, when ASB status is used, it is desirable for the host to be in a reverse idle state. However, if the host computer cannot always be in the reverse idle state, it is necessary to enter Reverse Mode regularly to watch for ASB status. If the host is not in the Reverse Mode for a long time, and the

printer has to store ASB status changes to be transmitted, the following 2 sets (8 bytes) of ASB status are changed to special data and transmitted prior to other transmission data when the host enters Reverse Mode:

- ASB-1: Status information that shows whether status changes occurred
- ASB-2: The latest ASB status information

If bits have a different value between (ASB-1) and (ASB-2), this means at least one change has occurred. An example is shown below:

	First byte	Second byte	Third byte	Fourth byte
ASB-1	0011 1000	0000 0000	0110 0011	0000 1111
ASB-2	0001 0000	0000 0000	0110 0011	0000 1111

Bit 5 and 3 of the first byte are different from (ASB-1) and (ASB-2). From this information, you can see that [The cover is shutting now and On line though Off line (Bit 3) by cover opening Bit5)].

- Basic ASB status can be differentiated by other transmission data by Bit 0, 1, 4, and 7 of the first byte. Process the transmitted data from the printer as ASB status which is consecutive 3 byte if it is "0xx1xx00" [x = 0 or 1]. However, the processing shown in the following is necessary in the identifying processing of ASB status.
  - When the host communicates with the printer by XON/XOFF control, 4 bytes of data may interrupt ASB status; therefore, 4-byte code except for the XOFF code, is processed as ASB status. ASB status configuration is different from that of the XOFF code.

[Model-dependent variations]

**TM-J2000/J2100, TM-T90, TM-T88IV, TM-T70, TM-L90, TM-P60, TM-U230, TM-U220**

### Program Example for all printers

```
PRINT #1, CHR$(&H1D);"a";CHR$(4); ←Enable "Error" status
```

## TM-J2000/J2100

The default value is set by Msw1-3.

■ Third byte (paper sensor information)

- When the cover is open, the status of the roll paper end sensor (bit 2, 3) retains the value when the cover was closed immediately before.

## TM-T90

The default value is set by Msw 1-3.

■ Third byte (paper sensor information)

- When the cover is open, the status of the roll paper end sensor (bit 2, 3) retains the value when the cover was closed immediately before.

## TM-L90

### TM-L90 with Peeler

The default value is set by Msw 1-3.

The peeling issuing mode and the continuous issuing mode can be selected by a switch. This is a slide switch that can be used when the roll paper cover is opened.

■ Basic second byte (printer information)

- Bit 0 is changed when **GS ^** is executed or when the printer is in one of the following status conditions when the peeling issuing mode is selected:

- Waiting for the paper feed button to be pressed with the cover closed.

- Waiting for the paper feed button to be pressed to remove a label (when the label peeling detector cannot detect paper due to sunlight)

- If the cause of the recoverable error (bit 2) is the paper layout error, the printer can recover from the error by opening/closing the roll paper cover or by the **DLE ENQ** command or pressing the paper feed button only when memory switch Msw8-1 or Msw8-2 is OFF. See Function 3 of **GS E**.

■ Basic third byte (paper sensor information)

# CONFIDENTIAL

- When the cover is open, the status of the roll paper end sensor (bit 2, 3) retains the value when the cover was closed immediately before.
- Basic fourth byte (paper sensor information)
- Bits 0 and 2 indicate the following status:
  - Fourth byte (paper sensor information)

Bit	Binary	Hex	Decimal	Status for ASB
0	0	00	0	Not waiting for a label to be removed
	1	01	1	Waiting for a label to be removed
1	—	—	—	Reserved
2	0	00	0	Paper present in label peeling detector
	1	04	4	No paper present in label peeling detector
3	—	—	—	Reserved
4	0	00	0	Not used. Fixed to Off.
5,6	—	—	—	Reserved
7	0	00	0	Not used. Fixed to Off.

... how to use  
this table

- Bit 0: When the continuous issuing is selected, this bit is always 0.
- Bit 2: When the peeling issuing mode is selected, this bit is changed during paper feeding or when a label is in the peeling position. When a label removal is checked by pressing the paper feed button, this bit may be incorrect. When the continuous issuing mode is selected, this bit is always 1.

## TM-L90 Models without Peeler

The default value is set by Msw 1-3.

## ■ Basic second byte (printer information)

- If the cause of the recoverable error (bit 2) is the paper layout error, the printer can recover from the error by opening/closing the roll paper cover or by the **DLE ENQ** command or pressing the paper feed button only when memory switch Msw8-2 is OFF. See Function 3 of **GS E**.

## ■ Basic third byte (paper sensor information)

- When the cover is open, the status of the roll paper end sensor (bit 2, 3) retains the value when the cover was closed immediately before.

## **TM-T88IV**

The default value is set by DIP switch 2-1.

## ■ Second byte (printer information)

- Bits 0, 1, and 2 of the second byte are undefined.

## ■ Third byte (paper sensor information)

- When the cover is open, the status of the roll paper end sensor (bit 2, 3) retains the value when the cover was closed immediately before.

## **TM-T70**

The default value is set by DIP switch 2-1.

## ■ Second byte (printer information)

- Bits 0, 1, and 2 of the second byte are undefined.

## ■ Third byte (paper sensor information)

- When the cover is open, the states of the roll paper near end sensor (bit 0, 1) and the roll paper end sensor (bit 2, 3) retain the values when the cover was closed immediately before.

## TM-P60

### TM-P60 with Peeler

The function of Bit 0 of parameter (n) is not supported. Specify 1 to bit 0 of n or bits of "Reserved."

#### ■ First byte (printer information)

- Bit 2 status is as follows:

n: Bit	Binary	Hex	Decimal	Function
2	0	00	0	Does not go to offline by low battery.
	1	04	4	Offline by low battery.

- Bit 5 indicates the open/closed status of the peeler cover.
- Basic second byte (printer information)
  - Bits 0 and 3 of the second byte are not supported.
  - If the cause of an automatically recoverable error (bit 6) is a "paper error," recovery from the error is possible by opening and closing the peeler cover.
- Basic third byte (paper sensor information)
  - Bits 0 and 1 of the third byte are not supported.
  - When the cover is open, the status of the roll paper end sensor (bit 2, 3) retains the value when the cover was closed immediately before.
- Basic fourth byte (paper sensor information)

- **Bits 0 and 2 indicate the following status:**

Bit	Binary	Hex	Decimal	Status for ASB
0	0	00	0	Not waiting for a label to be removed
	1	01	1	Waiting for a label to be removed
1	—	—	—	Reserved
2	0	00	0	Paper present in label peeling detector
	1	04	4	No paper present in label peeling detector
3	—	—	—	Reserved
4	0	00	0	Not used. Fixed to Off.
5,6	—	—	—	Reserved
7	0	00	0	Not used. Fixed to Off.

*... how to use this table*

- **Bit 0:** When the continuous issuing is selected, this bit is always 0.
- **Bit 2:** When the peeling issuing mode is selected, this bit is changed during paper feeding or when a label is in the peeling position. When the continuous issuing mode is selected, this bit is always 1.

The peeling issuing mode/continuous issuing mode is selected with the operation shown below.

- **Selecting the peeling issuing mode**

Step	Operation
1	Press the cover open button, and open the peeler cover.

2	If the paper roll cover was open in Step 1, close the paper roll cover.
3	Press the peeler changeover lever. The peeler holder is raised.
4	Close the peeler cover.

- **Selecting the continuous issuing mode**

Step	Operation
1	Press the cover open button, and open the peeler cover.
2	If the paper roll cover was open in Step 1, close the paper roll cover.
3	Fold up the peeler holder.
4	Close the peeler cover.

### TM-P60 Models without Peeler

The function of Bit 0 of parameter (n) is not supported. Specify 1 to bit 0 of n or bits of "Reserved."

- **First byte (printer information)**

- **Bit 2 status is as follows:**

n: Bit	Binary	Hex	Decimal	Function
2	0	00	0	Does not go to offline by low battery.
	1	04	4	Offline by low battery.

- **Basic second byte (printer information)**

- **Bits 0 and 2 of the second byte are not supported.**

- **Basic third byte (paper sensor information)**

- **Bits 0 and 1 of the third byte are not supported.**

- **When the cover is open, the status of the roll paper end sensor (bit 2, 3) retains the value when the cover was closed immediately before.**



## **TM-U230**

The default value is set by DIP switch 1-8.

- Second byte (printer information)
- Bit 1 of the second byte is undefined.

## **TM-U220**

The default value is set by DIP switch 1-8.

- Second byte (printer information)
- Bit 0, and 1 of the second byte are undefined.
- Basic third byte (paper sensor information)
- The roll paper near-end sensor is an option. If the printer is not equipped with the paper near-end sensor, bits 0 and 1 of the third byte are always ON, "Paper adequate."
- When the cover is open, the status of the roll paper end sensor (bit 2, 3) retains the value when the cover was closed immediately before.

## GS j

[Name] Enable/disable Automatic Status Back (ASB) for ink

[Format] ASCII GS j **n**  
 Hex 1D 6A **n**  
 Decimal 29 106 **n**

[Range]  $0 \leq n \leq 255$

[Default] When DIP switch or memory switch (BUSY condition) is Off: **n** = 0  
 When DIP switch or memory switch (BUSY condition) is On: **n** = 1

[Printers not featuring this command] **TM-T90**, **TM-T88IV**, **TM-T70**, **TM-L90**, **TM-P60**, **TM-U230**, **TM-U220**

[Description] Enables or disables the ink ASB (Automatic Status Back) and specifies the status items to include, using **n** as follows:

<b>n:</b> <b>Bit</b>	<b>Function</b>	<b>Binary</b>	<b>Hexadecimal</b>	<b>Decimal</b>
0	Disable online/offline status of the ink mechanism	0	00	0
	Enable online/offline status of the ink mechanism	1	01	1
1	Disable ink status detection	0	00	0
	Enable ink status detection	1	02	2
2~7	Reserved	0	00	0

- [Notes]
- ASB (Automatic Status Back) transmits the status such as ink near-end, ink cartridge installed/not installed automatically to the printer in real-time. It is called [ASB function] and the status is [ASB status]. If you use ASB, application can acquire the printer change in real-time and passively.
  - Enabling any status (except **n** = 0) starts ink ASB. Then the current ink ASB status is transmitted. After that, when ASB is active, the selected enabled ink ASB status is transmitted each time the status changes.
  - When **n** = 0, ink ASB is disabled. When ASB is disabled, ink ASB status is not transmitted.
  - If ASB is enabled when the printer is disabled by **ESC =**, the printer transmits a 4-byte status message whenever the status changes.

- This command is effective until **ESC @** is executed, the printer is reset, or the power is turned off.
- All ink ASB status items represent the enabled status whenever the status changes. Therefore, the disabled status items may change, because each status transmission represents the current status.
- The ink ASB status, corresponding to each bit for **n** are as follows:

<b>n</b>		<b>ASB status description</b>	
<b>Bit</b>	<b>Status</b>	<b>ASB status</b>	<b>Bit</b>
0	Online/offline status of ink mechanism	Detect ink end	Status A: Bit 1 Status B: Bit 1
		Detect ink cartridge	Status A: Bit 2 Status A: Bit 3
		Cleaning	Status A: Bit 5
1	Ink detection status	Detect ink near-end	Status A: Bit 0 Status B: Bit 0
		Detect ink end	Status A: Bit 1 Status B: Bit 1
		Detect ink cartridge	Status A: Bit 2 Status B: Bit 3

- The ink ASB status is a 4-byte message, consisting of the following table.

<b>Transmitted data</b>	<b>Hexadecimal</b>	<b>Decimal</b>	<b>Data amount</b>
Header	35H	53	1 byte
Status A (*1)	40H ~ 7FH	64 ~ 127	1 byte
Status B (*2)	40H ~ 7FH	64 ~ 127	1 byte
NUL	00H	0	1 byte

■ (\*1) Status A is shown in the table below:

Bit	Function	Binary	Hexadecimal	Decimal
0	Ink end not detected (1st color)	0	00	0
	Ink end detected (1st color)	1	01	1
1	Ink end not detected (1st color)	0	00	0
	Ink end detected (1st color)	1	02	2
2	Ink cartridge installed (1st color)	0	00	0
	Ink cartridge not installed (1st color)	0	04	4
3	Ink cartridge installed (2nd color)	0	00	0
	Ink cartridge not installed (2nd color)	1	08	8
4	Reserved	-	-	-
5	Cleaning is not being performed	0	00	0
	Cleaning is being performed	1	20	32
6	Fixed	1	40	64
7	Fixed	0	00	0

■ (\*2) Status B is shown in the table below:

Bit	Function	Binary	Hexadecimal	Decimal
0	Ink near-end not detected (2nd color)	0	00	0
	Ink near-end detected (2nd color)	1	01	1
1	Ink end not detected (2nd color)	0	00	0
	Ink end detected (2nd color)	1	02	2
2 ~ 5	Reserved	-	-	-
6	Fixed	1	40	64
7	Fixed	0	00	0

- When block data [Header ~ NUL] is being transmitted, ASB status cannot be transmitted. Therefore, you cannot get the printer status change through ASB status when Block data [Header ~ NUL] is transmitted.
- With a serial interface, the printer transmits a 4-byte ASB status message without confirming whether the host can receive data.
- With a parallel interface, when ASB status is used, it is desirable for the host to be in a reverse idle state. However, if the host computer cannot always be in the reverse idle state, it is necessary to enter Reverse Mode regularly to watch for ASB status. If the host is not in the Reverse Mode for a long time, and the printer has to store ASB status changes to be transmitted, the following 2 sets (8 bytes) of ASB status are changed to special data and transmitted prior to other transmission data when the host enters Reverse Mode:
  - ASB-1: Status information that shows whether status changes occurred
  - ASB-2: The latest ASB status information

If bits have a different value between (ASB-1) and (ASB-2), this means at least one change has occurred. An example is shown below:

	Header	Status A	Status B	NUL
ASB-1	0011 0101	0110 0000	0100 0000	0000 0000
ASB-2	0011 0101	0100 0000	0100 0000	0000 0000

Bit 5 of Status A for ASB-1 and ASB-2 is different. From this information, you can see that the printer executed a cleaning but it has already finished.

- Ink ASB status can be differentiated from other transmission data by identified data of the transmission data group. If the header from the printer is [Hex = 35H/Decimal = 53], the host should process the data up to NUL [Hex = 00H/Decimal = 0] as ASB status.

[Model-dependent variations] **TM-J2000/J2100**

### Program Example

```
PRINT #1, CHR$( &H1D ); "j"; CHR$( 2 ); ← Only sensor status can be selected.
```

## TM-J2000/J2100

The default is selected by memory switch 3-1.

When an ink near-end is detected, the INK OUT light blinks. It is possible to print approximately 20,000 characters using Font B with print control mode set to economy printing from the time an ink near-end is detected to the time an ink end is detected. However, the value is only a reference value; it depends on such environmental factors as printing data and the timing of head cleaning. Therefore, replace an old ink cartridge with a new one when an ink near-end is detected.

Two parts of a **TM-J2100 (two-color printing model)** ink cartridge are combined, and the presence of the cartridge is detected by one detector. Therefore, both of the following states are the same.

Bit 2 of Ink ASB Status A

Bit 3 of Ink ASB Status A

Ink ASB Status A: **TM-J2000** (single-color) does not support bit 3.

Ink ASB Status B: **TM-J2000** (single-color) does not support bits 0 and 1.

## GS r

[Name] Transmit status

[Format] ASCII GS r **n**  
 Hex 1D 72 **n**  
 Decimal 29 114 **n**

[Range] **TM-J2000/J2100: n = 1, 2, 4, 49, 50, 52**  
**TM-T90, TM-T88IV, TM-T70, TM-L90, TM-U230, TM-U220: n = 1, 2, 49, 50**  
**TM-P60: n = 1, 49**

[Printers not featuring this command] None

[Description] Transmits the status using **n** as follows:

<b>n</b>	<b>Function</b>
1, 49	Transmits paper sensor status
2, 50	Transmits drawer kick-out connector status
4, 52	Transmits ink status

- [Notes]
- Each status is 1 byte.
  - The status to be transmitted is as follows:
    - Paper sensor status (**n** = 1, 49)

<b>Bit</b>	<b>Binary</b>	<b>Hex</b>	<b>Decimal</b>	<b>Status</b>
0, 1	00	00	0	Roll paper near-end sensor: paper adequate.
	11	03	3	Roll paper near-end sensor: paper not present.
2, 3	00	00	0	Roll paper end sensor: paper present.
	11	0C	12	Roll paper end sensor: paper not present.
4	0	00	0	Not used. Fixed to Off.
5,6	—	—	—	Undefined.
7	0	00	0	Not used. Fixed to Off.

*... how to use this table*

- Some paper sensors are not present, depending on the printer model. The names of some paper sensors are different, depending on the printer model.

■ The status to be transmitted is as follows:

- Drawer kick-out connector status (**n** = 2, 50)

Bit	Binary	Hex	Decimal	Status
0	0	00	0	Drawer kick-out connector pin 3 is LOW.
	1	01	1	Drawer kick-out connector pin 3 is HIGH.
1-3	—	—	—	Undefined.
4	0	00	0	Not used. Fixed to Off.
5, 6	—	—	—	Undefined.
7	0	00	0	Not used. Fixed to Off.

... how to use  
this table

■ The status to be transmitted is as follows:

- Ink status (**n** = 2, 50)

Bit	Binary	Hex	Decimal	Function
0	0	00	0	Ink end not detected (1st color)
	1	01	1	Ink end detected (1st color)
1	0	00	0	Ink end not detected (2nd color)
	1	02	2	Ink end detected (2nd color)
2, 3	-	-	-	Undefined.
4	0	00	0	Not used. Fixed to Off.
5, 6	-	-	-	Undefined.
7	0	00	0	Not used. Fixed to Off.

... how to use  
this table

■ When you use this command, obey the following rules.



- After the host PC transmits the function data, the printer will send response data or status data back to the PC. Do not transmit more data from the PC until the response data or status data are received from the printer.
  - When operating with a serial interface, be sure to configure operation so that the host computer uses the printer only when it is READY.
  - With a parallel interface, a real-time status is stored in the transmission buffer of the printer temporarily the same as the other transmission data (except for ASB status), and when the host enters reverse mode, data is transmitted in order from the beginning of the transmission buffer. The transmission buffer is 99 bytes; therefore, data that exceeds 99 bytes is ignored. When using this command, the host should be changed to the reverse mode immediately and execute a receive processing of status.
- After the print changing line operation ends, paper sensor status (**n** = 1, 49) is transmitted. Therefore if use **GS r 1** according to the printing instruction, host recognizes the print completion by receiving paper sensor status.
  - Normal status can be differentiated by the information of bits 4, and 7 from other transmission data. If the data transmitted from the printer after outputting **GS r** to the printer is "0xx1xx10" (x = 0 or 1), process the data as a normal status.

[Model-dependent variations]

**TM-J2000/J2100**, **TM-T90**, **TM-T88IV**, **TM-T70**, **TM-L90**, **TM-P60**, **TM-U230**,  
**TM-U220**

### Program Example for all printers

```
PRINT #1, CHR$(&H1D);"r";CHR$(1); ←Transmits paper sensor status
```

## **TM-J2000/J2100**

- **Paper sensor status (n = 1, 49)**
  - **When the roll paper end sensor detects a paper-end, the printer goes offline and does not execute this command. Therefore, bits 2 and 3 of the paper sensor status do not transmit a paper-end status.**
- **Ink status (n = 4, 52)**
  - **The function of bit 1 is not supported in TM-J2000 (Single color).**

## TM-T90, **TM-T88IV**, TM-L90

### ■ Paper sensor status (n = 1, 49)

- When the roll paper end sensor detects a paper-end, the printer goes offline and does not execute this command. Therefore, bits 2 and 3 of the paper sensor status do not transmit a paper-end status.

## TM-T70

### ■ Paper sensor status (n = 1, 49)

- When the roll paper end sensor detects a paper-end, the printer goes offline and does not execute this command. Therefore, bits 2 and 3 of the paper sensor status do not transmit a paper-end status.
- When the cover is open, the status of the roll paper near end sensor (bit 0, 1) when the cover is open retain the value when the cover was closed immediately before.

## TM-P60

### ■ Paper sensor status (n = 1, 49)

- Bits 0 and 1 are not supported.
- When the roll paper end sensor detects a paper-end, the printer goes offline and does not execute this command. Therefore, bits 2 and 3 of the paper sensor status do not transmit a paper-end status.

## TM-U230

### ■ Paper sensor status (n = 1, 49)

- When the roll paper end sensor detects a paper-end, the printer goes offline and does not execute this command. Therefore, bits 2 and 3 of the paper sensor status do not transmit a paper-end status.

## TM-U220

### ■ Paper sensor status (n = 1, 49)

- The roll paper near-end sensor is an option. If the printer is not equipped with the paper near-end sensor, bits 0 and 1 of the third byte are always ON, "Paper adequate."
- When the roll paper end sensor detects a paper-end, the printer goes offline and does not execute this command. Therefore, bits 2 and 3 of the paper sensor status do not transmit a paper-end status.

## BAR CODE COMMANDS

Command	Name
---------	------

---

<b>GS H</b>	Select print position of HRI characters
<b>GS f</b>	Select font for HRI characters
<b>GS h</b>	Set bar code height
<b>GS k</b>	Print bar code
<b>GS w</b>	Set bar code width

## GS H

[Name] Select print position of HRI characters

[Format] ASCII GS H **n**  
 Hex 1D 48 **n**  
 Decimal 29 72 **n**

[Range]  $0 \leq n \leq 3$   
 $48 \leq n \leq 51$

[Default] **n** = 0

[Printers not featuring this command] **TM-U230**, **TM-U220**

[Description] Selects the print position of Human Readable Interpretation (HRI) characters when printing a bar code, using **n** as follows:

<b>n</b>	<b>Print position</b>
0, 48	Not printed
1, 49	Above the bar code
2, 50	Below the bar code
3, 51	Both above and below the bar code

- [Notes]
- HRI characters are printed using the font specified by **GS f**.
  - This command setting is effective until performing of **ESC @**, reset or power-off.

- HRI character is Human Readable Interpretation character indicated with bar code.

## Program Example for all printers

```
PRINT #1, CHR$(&H1D);"h";CHR$(80); ←Set height
PRINT #1, CHR$(&H1D);"f";CHR$(0); ←Select font
FOR n=0 to 3
  PRINT #1, CHR$(&H1D);"H";CHR$(n); ←Select print position
  PRINT #1, CHR$(&H1D);"k";CHR$(2); ←Print bar code
  PRINT #1, "4965957073797";CHR$(0);
  PRINT #1, CHR$(&HA);
NEXT n
```

## Print Sample



## GS f

[Name] Select font for HRI characters

[Format] ASCII GS f **n**  
 Hex 1D 66 **n**  
 Decimal 29 102 **n**

[Range] **TM-J2000/J2100, TM-T90, TM-L90:**  
**n = 0, 1, 48, 49 (Other than Japanese model)**  
**0 ≤ n ≤ 2, 48 ≤ n ≤ 50 (Japanese model)**  
**TM-T88IV, TM-T70: n = 0, 1, 48, 49**  
**TM-P60: 0 ≤ n ≤ 2, 48 ≤ n ≤ 50**

[Default] **n = 0**

[Printers not featuring this command] **TM-U230, TM-U220**

[Description] Selects a font for the Human Readable Interpretation (HRI) characters when printing a bar code, using **n** as follows:

<b>n</b>	<b>Font of HRI characters</b>
0, 48	Font A
1, 49	Font B
2, 50	Font C

- [Notes]
- The font set by this command is effective only for HRI character.
  - The composition of the character of each font is different depending on the model.
  - Configurations of Font A and Font B are different, depending on the printer model.
  - HRI characters are printed at the position specified by **GS H**.
  - HRI character is Human Readable Interpretation character indicated with bar code.

[Model-dependent variations]

**TM-J2000/J2100, TM-T90, TM-T88IV, TM-T70, TM-L90, TM-P60**

## Program Example for all printers

```
PRINT #1, CHR$(&H1D);"h";CHR$(80); ←Set height
PRINT #1, CHR$(&H1D);"H";CHR$(2); ←Select print position
PRINT #1, CHR$(&H1D);"f";CHR$(0); ←Select font
PRINT #1, CHR$(&H1D);"k";CHR$(2); ←Print bar code
PRINT #1, "496595707379";CHR$(0);
PRINT #1, CHR$(&HA);
PRINT #1, CHR$(&H1D);"f";CHR$(1); ←Select font
PRINT #1, CHR$(&H1D);"k";CHR$(2); ←Print bar code
PRINT #1, "496595707379";CHR$(0);
```

## Print Sample



← Font A



← Font B

**TM-J2000/J2100, TM-T90, TM-L90**

**[Other than Japanese model]**

**Character configurations:**

**Font A: 12 × 24**

**Font B: 9 × 17**

**[Japanese model]**

**Character configurations:**

**Font A: 12 × 24**

**Font B: 10 × 24**

**Font C: 8 × 16**

**TM-T88IV**

**Character configurations:**

**Font A: 12 × 24**

**Font B: 9 × 17**

# CONFIDENTIAL

## TM-T70

[Other than Japanese model]

Character configurations:

Font A: 12 × 24

Font B: 9 × 17

[Japanese model]

Character configurations:

Font A: 12 × 24

Font B: 8 × 16

## TM-P60

Character configurations:

Font A: 12 × 24

Font B: 10 × 24

Font C: 8 × 16



## GS h

[Name] Set bar code height

[Format] ASCII GS h **n**  
 Hex 1D 68 **n**  
 Decimal 29 104 **n**

[Range]  $1 \leq n \leq 255$

[Default] **TM-J2000/J2100, TM-T90, TM-T88IV, TM-T70, TM-L90, TM-P60: n = 162**

[Printers not featuring this command] **TM-U230, TM-U220**

[Description] Sets the height of a bar code to **n** dots.

[Notes] ■ The units for **n** depend on the printer model.

■ This command setting is effective until performing of **ESC @**, reset or power-off.

[Model-dependent variations] **TM-J2000/J2100, TM-T88IV, TM-T90, TM-T70, TM-L90, TM-P60**

### Program Example for all printers

```
PRINT #1, CHR$(&H1D);"h";CHR$(50); ←Set height to 50
PRINT #1, CHR$(&H1D);"k";CHR$(2); ←Print bar code
PRINT #1, "496595707379";CHR$(0);
PRINT #1, CHR$(&HA);
PRINT #1, CHR$(&H1D);"h";CHR$(100); ←Set height to 100
PRINT #1, CHR$(&H1D);"k";CHR$(2); ←Print bar code
PRINT #1, "496595707379";CHR$(0);
```

### Print Sample

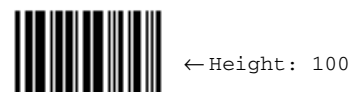
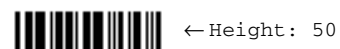

### **TM-J2000/J2100, TM-T88IV**

**A set unit is one dot. One dot corresponds to 0.141 mm {1/180 inch}.**

# CONFIDENTIAL

## **TM-T90, TM-T70**

A set unit is one dot.

For other than Japanese model, one dot corresponds to 0.141 mm {1/180 inch}.

For Japanese model, one dot corresponds to 0.125 mm {1/203 inch}.

## **TM-L90, TM-P60**

A set unit is one dot. One dot corresponds to 0.125 mm {1/203 inch}.

## GS k

[Name]	Print bar code					
[Format]	(A) ASCII	GS	k	<b>m</b>	<b>d1 ... dk</b>	<b>NUL</b>
	Hex	1D	6B	<b>m</b>	<b>d1 ... dk</b>	<b>NUL</b>
	Decimal	29	107	<b>m</b>	<b>d1 ... dk</b>	<b>NUL</b>
	(B) ASCII	GS	k	<b>m</b>	<b>n</b>	<b>d1 ... dn</b>
	Hex	1D	6B	<b>m</b>	<b>n</b>	<b>d1 ... dn</b>
	Decimal	29	107	<b>m</b>	<b>n</b>	<b>d1 ... dn</b>

[Range] **TM-J2000/J2100, TM-T90, TM-T88IV, TM-T70, TM-L90:**

**(A)  $0 \leq m \leq 6$**

**(B)  $65 \leq m \leq 73$**

**TM-P60:**

**(A)  $0 \leq m \leq 6$**

**(B)  $65 \leq m \leq 78$  [TM-P60 with Peeler]**

**$65 \leq m \leq 73$  [TM-P60 other than Peeler model]**

The domain of d and k of <Function A> and of n and d of <Function B> differs according to the bar code format. Refer to the [Function] table.

[Printers not featuring this command] **TM-U230, TM-U220**

[Description] Prints the bar code using the bar code system specified by **m**.  
<Function A>

<b>m</b>	<b>Bar code system</b>	<b>Bar code data ("SP" in the table indicates space.)</b>			
		<b>Amount of data</b>	<b>The range of k</b>	<b>Characters</b>	<b>Data (d)</b>
0	UPC-A	Fixed	<b>k</b> = 11, 12	0~9	$48 \leq \mathbf{d} \leq 57$
1	UPC-E	Fixed	$6 \leq \mathbf{k} \leq 8,$ <b>k</b> = 11, 12	0~9	$48 \leq \mathbf{d} \leq 57$ [However, <b>d1</b> = 48 when <b>k</b> = 7, 8, 11, 12]
2	JAN13 (EAN13)	Fixed	<b>k</b> = 12, 13	0~9	$48 \leq \mathbf{d} \leq 57$
3	JAN8 (EAN8)	Fixed	<b>k</b> = 7, 8	0~9	$48 \leq \mathbf{d} \leq 57$

<b>m</b>	<b>Bar code system</b>	<b>Bar code data ("SP" in the table indicates space.)</b>			
		<b>Amount of data</b>	<b>The range of k</b>	<b>Characters</b>	<b>Data (d)</b>
4	CODE39	Can be changed	$1 \leq k$	0~9, A~Z SP, \$, %, *, +, -, ., /	48 £ d £ 57, 65 £ d £ 90, <b>d</b> = 32, 36, 37, 42, 43, 45, 46, 47
5	ITF (Interleaved 2 of 5)	Can be changed	$1 \leq k$ (even number)	0~9	$48 \leq d \leq 57$
6	CODABAR (NW-7)	Can be changed	$1 \leq k$	0~9, A~D, a~ d \$, +, -, ., /, ;	$48 \leq d \leq 57, 65 \leq d \leq 68, 97 \leq d \leq 100$ <b>d</b> = 36, 43, 45, 46, 47, 58 ( $65 \leq d1 \leq 68, 65 \leq dk \leq 68, 97 \leq d1 \leq 100, 97 \leq dk \leq 100$ )

- **k** indicates the number of bytes of bar code data . **k** is an explanation parameter; therefore it does not need to be transmitted.
- **d** specifies the character code data of the bar code data to be printed.

<Function B>

<b>m</b>	<b>Bar code system</b>	<b>Bar code data ("SP" in the table indicates space.)</b>			
		<b>Amount of data</b>	<b>The range of n</b>	<b>Characters</b>	<b>Data (d)</b>
65	UPC-A	Fixed	$n = 11, 12$	0~9	$48 \leq d \leq 57$
66	UPC-E	Fixed	$6 \leq n \leq 8$ $n = 11, 12$	0~9	$48 \leq d \leq 57$ [However, <b>d 1</b> = 48 when <b>n</b> = 7, 8, 11, 12 is specified] )
67	JAN13 (EAN13)	Fixed	$n = 12, 13$	0~9	$48 \leq d \leq 57$
68	JAN8 (EAN8)	Fixed	$n = 7, 8$	0~9	$48 \leq d \leq 57$
69	CODE39	Can be changed	$1 \leq n \leq 255$	0~9, A~Z SP, \$, %, *, +, -, ., /	$48 \leq d \leq 57, 65 \leq d \leq 90,$ <b>d</b> = 32, 36, 37, 42, 43, 45, 46, 47

<b>m</b>	<b>Bar code system</b>	<b>Bar code data ("SP" in the table indicates space.)</b>			
		<b>Amount of data</b>	<b>The range of n</b>	<b>Characters</b>	<b>Data (d)</b>
70	ITF (Interleaved 2 of 5)	Can be changed (even number)	$2 \leq n \leq 255$ (even number)	0~9	$48 \leq d \leq 57$
71	CODABAR (NW-7)	Can be changed	$1 \leq n \leq 255$	0~9, A~D, a~d \$, +, -, ., /, :	$48 \leq d \leq 57, 65 \leq d \leq 68, 97 \leq d \leq 100$ $d = 36, 43, 45, 46, 47, 58$ ( $65 \leq d1 \leq 68, 65 \leq dn \leq 68, 97 \leq d1 \leq 100, 97 \leq dn \leq 100$ )
72	CODE93	Can be changed	$1 \leq n \leq 255$	00H~7FH	$0 \leq d \leq 127$
73	CODE128	Can be changed	$2 \leq n \leq 255$	00H~7FH	$0 \leq d \leq 127$ [However $d1 = 123, 65 \leq d2 \leq 67$ ]
74	UCC/EAN128	Can be changed	$2 \leq n \leq 255$	NUL~SP(7FH)	$0 \leq d \leq 127$
75	RSS-14	Can be changed	$n = 13$	0~9	$48 \leq d \leq 57$
76	RSS-14 Truncated	Can be changed	$n = 13$	0~9	$48 \leq d \leq 57$
77	RSS Limited	Can be changed	$n = 13$	0~9	$48 \leq d \leq 57$ [However $d1 = 48, 49$ ]
78	RSS Expanded	Can be changed	$2 \leq n \leq 255$	0~9, A~D, a~d SP, !, ", %, \$, ', (, ) , *, +, ,, -, ., /, :, ;, <, =, >, ?, _ , {	$48 \leq d \leq 57, 65 \leq d \leq 90, 97 \leq d \leq 122,$ $32 \leq d \leq 34, 37 \leq d \leq 47,$ $58 \leq d \leq 63, d = 95, 123$ [However $d1 = 40, 48 \leq d2 \leq 57,$ $48 \leq d3 \leq 57$ when $48 \leq d1 \leq 57, 48 \leq d2 \leq 57$ ]

- **n** specifies the number of bytes of bar code data.
- **d** specifies the character code data of the bar code data to be printed.
- Refer to GS ( k for printing the 2-dimensional RSS (Reduced Space Symbology) shown below.  
RSS-14 Stacked, RSS-14 Stacked Omnidirectional, RSS Expanded Stacked
- When standard mode is selected, this command is enabled only when the print position is at the head of a line or when no data exists in the print buffer.

[Notes]

- When page mode is selected, this command develops the bar code data in the print buffer but the printer does not print the bar code data.
- The bar code width that exceeds the print area cannot be specified.
- This command feeds as much paper as is required to print the bar code, regardless of the line spacing specified by line space setting commands.
- The bar code is not affected by print mode (emphasized, underline, or 90° clockwise-rotated), except for upside-down print mode.
- After bar code printing, the print position moves to the left end of the print area. The printer enters the status of print position at the head of a line or no data exists in the print buffer.
- The values of **m** from 0 to 6 in (A) and from 65 to 71 in (B) select the same bar code system, respectively. The printing results are the same.
- This command specifies **m** = 0 to 6 and ends with a **NUL** code.
- When an odd number of data is processed for ITF bar code system (**m** = 5), the printer ignores the last received data.
- The printer processes **n** bytes from the next data as bar code data by this command specifying **m** = 65 to 78.
- Print area does not include quiet zone (left/right margin) of bar code. Make sure to secure the quiet zone, using this command.

[Notes for UPC-A (**m** = 0, 65) process]

- Modular check character (1 character) is processed as follows:
  - Automatically added when processing data is 11 byte.
  - The 12th byte data is processed as a modular check character when processing data is 12 byte. In this case, modular check character is not checked.
- Left guard bar/center bar/right guard bar are added automatically.

[Notes for UPC-E (**m** = 66) process]

- Some models do not support settings of 6, 7, or 8 bytes for the amounts of data to process. For details, refer to [Model Information].

- If the amount of data to process is 6 bytes, the number system character (NSC) 0 is added automatically.
- If the amount of data to process is any of (7, 8, 11, 12 bytes), the first data (**d1**) is processed as number system character (NSC) so 0 must be specified.
- If **n** is out of the specified range or if **n** is an odd number when ITF bar code system (**m** = 70) is selected, this command is canceled and the following data is processed as normal data.
- Modular check character (1 character) is processed as follows:
  - If the amount of data to process is any of (6, 7, 11 bytes), it is added automatically.
  - The 12th byte data is processed as a modular check character when processing data is 12 byte. In this case, modular check character is not checked.
  - If the amount of data to process is 8 bytes, the 8th byte data is processed as a modular check character. However, the modular check character is not checked.
  - Modular check characters are data to decide the bar pattern; they are not printing data.
- Prints a 6-column short code that except NSC and modular check characters.
  - If the amount of data to process is 6 bytes, the shortened 6-digit code specified by (**d1...d6**) is printed. If the amount of data to process is either of (7, 8 bytes), the shortened 6-digit code specified by (**d2...d7**) is printed.
  - If the amount of data to process is either of (11, 12 bytes), a shortened 6-digit code generated from the (**d2...d11**) data in accordance with the table below is printed.

Data of transmitted by host PC										Printing data					
<i>d2</i>	<i>d3</i>	<i>d4</i>	<i>d5</i>	<i>d6</i>	<i>d7</i>	<i>d8</i>	<i>d9</i>	<i>d10</i>	<i>d11</i>	<i>D1</i>	<i>D2</i>	<i>D3</i>	<i>D4</i>	<i>D5</i>	<i>D6</i>
0 ~ 9	0 ~ 9	0	0	0	-	-	0 ~ 9	0 ~ 9	0 ~ 9	<i>d2</i>	<i>d3</i>	<i>d9</i>	<i>d10</i>	<i>d11</i>	0
0 ~ 9	0 ~ 9	1	0	0	-	-	0 ~ 9	0 ~ 9	0 ~ 9	<i>d2</i>	<i>d3</i>	<i>d9</i>	<i>d10</i>	<i>d11</i>	1
0 ~ 9	0 ~ 9	2	0	0	-	-	0 ~ 9	0 ~ 9	0 ~ 9	<i>d2</i>	<i>d3</i>	<i>d9</i>	<i>d10</i>	<i>d11</i>	2
0 ~ 9	0 ~ 9	3 ~ 9	0	0	-	-	-	0 ~ 9	0 ~ 9	<i>d2</i>	<i>d3</i>	<i>d4</i>	<i>d10</i>	<i>d11</i>	3
0 ~ 9	0 ~ 9	0 ~ 9	1 ~ 9	0	-	-	-	-	0 ~ 9	<i>d2</i>	<i>d3</i>	<i>d4</i>	<i>d5</i>	<i>d11</i>	4
0 ~ 9	0 ~ 9	0 ~ 9	0 ~ 9	1 ~ 9	-	-	-	-	5 ~ 9	<i>d2</i>	<i>d3</i>	<i>d4</i>	<i>d5</i>	<i>d6</i>	<i>d11</i>

Specify 0 at indicated data by "-" in the table.

When  $1 \leq \mathbf{d6} \leq 9$ , be sure to specify ( $5 \leq \mathbf{d11} \leq 9$ ).

- Left guard bar/right guard bar are added automatically.

[Notes for JAN13/EAN13 ( $\mathbf{m} = 2, 67$ ) process]

- Modular check character (1 character) is processed as follows:
  - Automatically added when processing data is 13 byte.
  - The 13th byte data is processed as a modular check character when processing data is 13 byte. In this case, modular check character is not checked.
- Left guard bar/center bar/right guard bar are added automatically.

[Notes for JAN8/EAN8 ( $\mathbf{m} = 3, 68$ ) process]

- Modular check character (1 character) is processed as follows:
  - Automatically added when processing data is 7 byte.
  - The 8th byte data is processed as a modular check character when processing data is 8 byte. In this case, modular check character is not checked.
- Left guard bar/center bar/right guard bar are added automatically.

[Notes for CODE39 ( $\mathbf{m} = 4, 69$ ) process]

- The printer processes the start character (ASCII = \*/Hex = 2Ah/Decimal = 42) as follows:
  - When the first bar code ( $\mathbf{d1}$ ) is "\*", the printer processes the data as a first character.
  - If the first bar code ( $\mathbf{d1}$ ) is not "\*", the printer adds a start character (\*) automatically.
- The printer processes the start character (ASCII = \*/Hex = 2Ah/Decimal = 42) as follows:
  - When the last bar code ( $\mathbf{dk}$  or  $\mathbf{dn}$ ) is "\*", the printer processes the data as a last character.
  - If the last bar code ( $\mathbf{dk}$  or  $\mathbf{dn}$ ) is not "\*", the printer adds a last character (\*) automatically.
  - When "\*" is processed during bar code data processing, the printer processes "\*" as a stop character. The printer prints data preceding "\*" and finishes command processing. Therefore, data following "\*" are processed as normal data.
- Check digits are not calculated and added.



[Notes for ITF (Interleaved 2 of 5) (**m** = 5, 70) process]

- Start code and stop code are added automatically.
- Check digits are not calculated and added.

[Notes for CODABAR (NW-7) (**m** = 6, 71) process]

- Start character and stop character are not added automatically. Transmit data including the codes.
  - Specify the start character (ASCII = "A" ~ "D," / "a" ~ "d," / Hex = 41H ~ 44H, 61H ~ 64H, / Decimal = 65 ~ 68, / 97 ~ 100) at beginning of the data (**d1**).
  - Specify the stop character (ASCII = "A" ~ "D," / "a" ~ "d," / Hex = 41H ~ 44H, 61H ~ 64H, / Decimal = 65 ~ 68, / 97 ~ 100) at end of the data (**dk** or **dn**).
  - Start character or stop character (ASCII = "A" ~ "D," / "a" ~ "d," / Hex = 41H ~ 44H, 61H ~ 64H, / Decimal = 65 ~ 68, / 97 ~ 100) cannot be specified in bar code data.
  - The character (ASCII = "a" ~ "d," / Hex = 61H ~ 64H, / Decimal = 97 ~ 100) is supported by some printer models.
- Check digits are not calculated and added.

[Notes for CODE93 (**m** = 72) process]

- Start code and stop code are added automatically.
- Check digits (2 character) are calculated and added automatically.
- When HRI characters are designated to be added, special character HRI characters are processed as follows.
  - The printer prints an HRI character " □ " as start and stop character.
  - The printer prints HRI characters "■ + an alphabetic character" as control characters (not printable characters).

[Notes for CODE128 (**m** = 73) process]

- The first two-byte (**d1**, **d2**) start character must be code set selection character (any of CODE A, CODE B, or CODE C) which selects the first code set.
- Check digit (1 character) is calculated and added automatically.

# CONFIDENTIAL

■ Special character HRI is processed as follows:

- The printer does not print HRI characters that correspond to the shift character or code set selection character (CODE A, CODE B, or CODE C).
- HRI characters of the function characters (FNC1, FNC2, FNC3, or FNC4) and control characters (in Hexadecimal: 00H to 1FH, 7FH / in Decimal 0 to 31, 127) are printed as spaces.

■ The range of data (d) that can be processed in each code set (CODE A, CODE B, CODE C) is shown in the table below. Data where the character field is diagonal cannot be used. Transmit the 2-byte data shown in the following table ([Hexadecimal = 7BH / Decimal = 123] + character code) from the host for the special characters and bar code data "{".

d		Character		
Hex	Decimal	CODE A	CODE B	CODE C
00	0	NUL		00
01	1	SOH		01
02	2	STX		02
03	3	ETX		03
04	4	EOT		04
05	5	ENQ		05
06	6	ACK		06
07	7	BEL		07
08	8	BS		08
09	9	HT		09
0A	10	LF		10
0B	11	VT		11
0C	12	FF		12
0D	13	CR		13
0E	14	SO		14
0F	15	SI		15
10	16	DLE		16
11	17	DC1		17
12	18	DC2		18
13	19	DC3		19
14	20	DC4		20
15	21	NAK		21
16	22	SYN		22
17	23	ETB		23
18	24	CAN		24
19	25	EM		25
1A	26	SUB		26
1B	27	ESC		27
1C	28	FS		28
1D	29	GS		29
1E	30	RS		30
1F	31	US		31
20	32	SP	SP	32
21	33	!	!	33
22	34	"	"	34
23	35	#	#	35
24	36	\$	\$	36

d		Character		
Hex	Decimal	CODE A	CODE B	CODE C
25	37	%	%	37
26	38	&	&	38
27	39	'	'	39
28	40	(	(	40
29	41	)	)	41
2A	42	=	=	42
2B	43	+	+	43
2C	44	.	.	44
2D	45	-	-	45
2E	46	.	.	46
2F	47	/	/	47
30	48	0	0	48
31	49	1	1	49
32	50	2	2	50
33	51	3	3	51
34	52	4	4	52
35	53	5	5	53
36	54	6	6	54
37	55	7	7	55
38	56	8	8	56
39	57	9	9	57
3A	58	:	:	58
3B	59	;	;	59
3C	60	<	<	60
3D	61	=	=	61
3E	62	>	>	62
3F	63	?	?	63
40	64	@	@	64
41	65	A	A	65
42	66	B	B	66
43	67	C	C	67
44	68	D	D	68
45	69	E	E	69
46	70	F	F	70
47	71	G	G	71
48	72	H	H	72
49	73	I	I	73

d		Character		
Hex	Decimal	CODE A	CODE B	CODE C
4A	74	J	J	74
4B	75	K	K	75
4C	76	L	L	76
4D	77	M	M	77
4E	78	N	N	78
4F	79	O	O	79
50	80	P	P	80
51	81	Q	Q	81
52	82	R	R	82
53	83	S	S	83
54	84	T	T	84
55	85	U	U	85
56	86	V	V	86
57	87	W	W	87
58	88	X	X	88
59	89	Y	Y	89
5A	90	Z	Z	90
5B	91	[	[	91
5C	92	\	\	92
5D	93	]	]	93
5E	94	^	^	94
5F	95	_	_	95
60	96		`	96
61	97		a	97
62	98		b	98
63	99		c	99
64	100		d	
65	101		e	
66	102		f	
67	103		g	
68	104		h	
69	105		i	
6A	106		j	
6B	107		k	
6C	108		l	
6D	109		m	
6E	110		n	

d		Character		
Hex	Decimal	CODE A	CODE B	CODE C
6F	111		o	
70	112		p	
71	113		q	
72	114		r	
73	115		s	
74	116		t	
75	117		u	
76	118		v	
77	119		w	
78	120		x	
79	121		y	
7A	122		z	
7B, 7B	123, 123		{	
7C	124			
7D	125		}	
7E	126		~	
7F	127		DEL	

d		Special Character		
Hex	Decimal	CODE A	CODE B	CODE C
7B, 31	123, 49	FNC1	FNC1	FNC1
7B, 32	123, 50	FNC2	FNC2	
7B, 33	123, 51	FNC3	FNC3	
7B, 34	123, 52	FNC4	FNC4	
7B, 41	123, 65		CODE A	CODE A
7B, 43	123, 66	CODE B		CODE B
7B, 43	123, 67	CODE C		CODE C
7B, 53	123, 83	SHIFT	SHIFT	

# CONFIDENTIAL

[Description: Applied to UCC/EAN128 (**m** = 74)]

- UCC/EAN128 processes the following structures.

(a) Basic structure

Start character	FNC 1	AI	Data part	Check digit A	Check digit B	Stop character
Automatically added		<b>(d1...dn)</b>			Automatically added	

(b) Concatenated code structure

Start character	FNC 1	AI	Data part	Check digit A	FNC 1	AI	Data part	Check digit A	Check digit B	Stop character
Automatically added		<b>(d1...dn)</b>						Automatically added		

- The start character number system character (CODE A, CODE B, CODE C), FNC1, check digit B (1 character), and stop character are added automatically.
- The 4 special characters (SP, "(", " "), " \*") are processed as shown in the table below.

<b>Special characters</b>			
<b>Character</b>	<b>Hex</b>	<b>Decimal</b>	<b>Processing</b>
SP	20	32	After <b>d1</b> , the first SP is processed as AI and the data part delimiter, and a space is inserted for the HRI characters. Spaces are inserted for the HRI characters for subsequent SP. In any case, SP does not constitute encoded data.

(	28	40	"(" is inserted for the HRI character. It can be used when you want the HRI characters that indicate AI to look nice when used with the pair of ")." ")." does not constitute encoded data.
)	29	41	After <b>d1</b> , the first ")" is processed as AI and the data part delimiter, and ")" is inserted for the HRI characters. ")" are inserted for the HRI characters for subsequent ")" . In any case, SP does not constitute encoded data.
*	2A	42	Check digit A (1 character), calculated with modulus 10 is added as the data part at the position of *. "*" is not an HRI character, but check digits are inserted for HRI characters.

- Examples of bar code data using special characters (SP, "(, " "), " "\*"") are shown below.

Example: When [AI = 01/data = 9501234567890/Specify to add check digit A/enclose AI in ()]  
 GS k 74 18 "(01)9501234567890\*"

When HRI characters are designated to be added, the HRI characters are [(01)95012345678903].

Example: When [AI = 01/data = 9501234567890/Specify to add check digit A/enclose AI in (), and insert a space between the data]  
 GS k 74 18 "(01)9501234567890\*"

When HRI characters are designated to be added, the HRI characters are [(01)95012345678903].

Example: When linking [AI = 01/data = 9501234567890/Specify to add check digit A/enclose AI in ()] and [AI=3102/data = 000400/enclose AI in ()], and separating the HRI characters between the link with a space

GS k 74 33 "(01)9501234567890\* {1(3102)000400"

When HRI characters are designated to be added, the HRI characters are [(01)95012345678903 (3102)000400].

- When HRI characters are designated to be added, (**d1...dn**) is printed as HRI characters. Automatically added data is not treated as HRI characters.
- The HRI characters of special characters are processed as follows. ("SP" indicates a space)
  - The HRI character of the start character (CODE A, CODE B, CODE C) is not printed.

# CONFIDENTIAL

- The HRI characters of the function characters (FNC1, FNC3) and the control characters (Hexadecimal = 00H - 1FH, 7FH / Decimal = 0 - 31, 127) are printed as spaces.
  - The HRI characters of special characters (SP, "(", " ") are printed as the respective characters (SP, "(", " ")
  - The HRI character of special character ("\*") prints a check digit.
  - The HRI characters of bar code data [{"{"+"(", " ")," "\*, " "{"}] are printed as the respective characters ("(", " ")," "\*, " "{"
- The range of data (d) that can be processed in each code set (CODE A, CODE B, CODE C) is shown in the table below. Data where the character field is diagonal cannot be used. Transmit the 2-byte data shown in the following table ([Hexadecimal = 7BH / Decimal = 123] + character code) from the host for the special characters (FNC1, FNC3) and bar code data "(", " ")," "\*, and "{".

d		Character			
Hex	Decimal	CODE A	CODE B	CODE C	
00	0	NUL		00	
01	1	SOH		01	
02	2	STX		02	
03	3	ETX		03	
04	4	EOT		04	
05	5	ENQ		05	
06	6	ACK		06	
07	7	BEL		07	
08	8	BS		08	
09	9	HT		09	
0A	10	LF		10	
0B	11	VT		11	
0C	12	FF		12	
0D	13	CR		13	
0E	14	SO		14	
0F	15	SI		15	
10	16	DLE		16	
11	17	DC1		17	
12	18	DC2		18	
13	19	DC3		19	
14	20	DC4		20	
15	21	NAK		21	
16	22	SYN		22	
17	23	ETB		23	
18	24	CAN		24	
19	25	EM		25	
1A	26	SUB		26	
1B	27	ESC		27	
1C	28	FS		28	
1D	29	GS		29	
1E	30	RS		30	
1F	31	US		31	
20	32				
21	33	!	!	33	
22	34	"	"	34	
23	35	#	#	35	
24	36	\$	\$	36	

d		Character			
Hex	Decimal	CODE A	CODE B	CODE C	
25	37	%	%	37	
26	38	&	&	38	
27	39	'	'	39	
7B, 28	123, 40	(	(	40	
7B, 29	123, 41	)	)	41	
7B, 2A	123, 42	*	*	42	
2B	43	+	+	43	
2C	44	,	,	44	
2D	45	-	-	45	
2E	46	.	.	46	
2F	47	/	/	47	
30	48	0	0	48	
31	49	1	1	49	
32	50	2	2	50	
33	51	3	3	51	
34	52	4	4	52	
35	53	5	5	53	
36	54	6	6	54	
37	55	7	7	55	
38	56	8	8	56	
39	57	9	9	57	
3A	58	:	:	58	
3B	59	;	;	59	
3C	60	<	<	60	
3D	61	=	=	61	
3E	62	>	>	62	
3F	63	?	?	63	
40	64	@	@	64	
41	65	A	A	65	
42	66	B	B	66	
43	67	C	C	67	
44	68	D	D	68	
45	69	E	E	69	
46	70	F	F	70	
47	71	G	G	71	
48	72	H	H	72	
49	73	I	I	73	

d		Character			
Hex	Decimal	CODE A	CODE B	CODE C	
4A	74	J	J	74	
4B	75	K	K	75	
4C	76	L	L	76	
4D	77	M	M	77	
4E	78	N	N	78	
4F	79	O	O	79	
50	80	P	P	80	
51	81	Q	Q	81	
52	82	R	R	82	
53	83	S	S	83	
54	84	T	T	84	
55	85	U	U	85	
56	86	V	V	86	
57	87	W	W	87	
58	88	X	X	88	
59	89	Y	Y	89	
5A	90	Z	Z	90	
5B	91	[	[	91	
5C	92	\	\	92	
5D	93	]	]	93	
5E	94	^	^	94	
5F	95	_	_	95	
60	96	`	`	96	
61	97	a	a	97	
62	98	b	b	98	
63	99	c	c	99	
64	100	d	d		
65	101	e	e		
66	102	f	f		
67	103	g	g		
68	104	h	h		
69	105	i	i		
6A	106	j	j		
6B	107	k	k		
6C	108	l	l		
6D	109	m	m		
6E	110	n	n		

d		Character			
Hex	Decimal	CODE A	CODE B	CODE C	
6F	111	o	o		
70	112	p	p		
71	113	q	q		
72	114	r	r		
73	115	s	s		
74	116	t	t		
75	117	u	u		
76	118	v	v		
77	119	w	w		
78	120	x	x		
79	121	y	y		
7A	122	z	z		
7B, 7B	123, 123	{	{		
7C	124				
7D	125	}	}		
7E	126	~	~		
7F	127	DEL	DEL		

d		Special Character		
Hex	Decimal	CODE A	CODE B	CODE C
7B, 31	123, 49	FNC1	FNC1	FNC1
7B, 33	123, 51	FNC3	FNC3	FNC3
20	32	SP	SP	SP
28	40	(	(	(
29	41	)	)	)
2A	42	*	*	*

[Description: Applied to RSS-14 (**m** = 75)]

- Transmit the 13-digit product identification number, excluding the application identifier (AI) and check digit, from the host.
- Adds the application identifier (AI) automatically. The AI is "01".
- Adds the check digit (1 character) automatically.
- Adds the guard pattern and finder pattern automatically.
- Prints the 18 characters of ["(01)", (d1...d13), check digit] as HRI characters when HRI characters are designated to be added.
- An example of bar code data is shown below.

When printing a bar code with the product identification number [2001234567890].

GS k 75 13 "2001234567890"

When HRI characters are designated to be added, the HRI characters are [(01)20012345678909].

- When the bar code height set with GS h is smaller than [33 times the module width], a bar code with a height (excluding the HRI characters) of [module width x 33] is printed, without reference to the GS h setting.

[Description: Applied to RSS-14 (**m** = 76)]

- Transmit the 13-digit product identification number, excluding the application identifier (AI) and check digit, from the host.
- Adds the application identifier (AI) automatically. The AI is "01".
- Adds the check digit (1 character) automatically.
- Adds the guard pattern and finder pattern automatically.
- Prints the 18 characters of ["(01)", (d1...d13), check digit] as HRI characters when HRI characters are designated to be added.
- An example of bar code data is shown below.

When printing a bar code with the product identification number [0001234567890].

GS k 76 13 "0001234567890"

When HRI characters are designated to be added, the HRI characters are [(01)00012345678909].

- When the bar code height set with GS h is smaller than [13 times the module width], a bar code with a height (excluding the HRI characters) of [module width x 13] is printed, without reference to the GS h setting.

[Description: Applied to RSS Limited (**m** = 77)]

- Transmit the 13-digit product identification number, excluding the application identifier (AI) and check digit, from the host.
- Adds the application identifier (AI) automatically. The AI is "01".
- Adds the check digit (1 character) automatically.
- Adds the guard pattern and finder pattern automatically.
- Prints the 18 characters of ["(01)", (d1...d13), check digit] as HRI characters when HRI characters are designated to be added.
- An example of bar code data is shown below.

When printing a bar code with the product identification number [1501234567890].

GS k 77 13 "1501234567890"

When HRI characters are designated to be added, the HRI characters are [(01)15012345678909].

- When the bar code height set with GS h is smaller than [10 times the module width], a bar code with a height (excluding the HRI characters) of [module width x 10] is printed, without reference to the GS h setting.

[Description: Applied to RSS Expanded (**m** = 78)]

- Transmit the 2-byte data shown in the following table ([Hexadecimal = 7BH / Decimal = 123] + character code) from the host for the special character (FNC1) and symbol data "(", ")". ("+" in the table is not included in the transmission data)

Data	Transmit data from the host		
	ASCII	Decimal	Hex
<b>FNC1</b>	{ + 1	7B + 31	123 + 49
(	{ + (	7B + 28	123 + 40
)	{ + )	7B + 29	123 + 41

- The special characters ("(", ")") are processed as shown in the table below.

Special characters			
Character	Hex	Decimal	Processing
(	28	40	"(" is inserted for the HRI character. It can be used when you want the HRI characters that indicate AI to look nice when used with the pair of ")." .
)	29	41	After <b>d1</b> , the first ")" is processed as AI and the data part delimiter, and ")" is inserted for the HRI characters. ")" are inserted for the HRI characters for subsequent ")" .

- Adds the guard pattern and finder pattern automatically.
- When HRI characters are designated to be added, special character HRI characters are processed as follows.
  - The HRI character of function character (FNC1) is not printed.
  - The HRI characters of special characters ("(", ")") are printed as the respective characters ("(", ")").
  - The HRI characters of bar code data [{" + ("(", ")")}] are printed as the respective characters ("(", ")").
- When the bar code height set with GS h is smaller than [34 times the module width], a bar code with a height (excluding the HRI characters) of [module width x 34] is printed, without reference to the GS h setting.)

### Program Example for all printers

```
PRINT #1, CHR$(&H1D); "h"; CHR$(80); ←Set height
PRINT #1, CHR$(&H1D); "k"; CHR$(2); ←Print bar code
PRINT #1, "496595707379"; CHR$(0);
PRINT #1, CHR$(&HA);
PRINT #1, CHR$(&H1D); "k"; CHR$(67); CHR$(12);
PRINT #1, "496595707379"; ←Print bar code
```

### Print Sample



[Model-dependent variations]

**TM-J2000/J2100, TM-T90, TM-L90, TM-T88IV, TM-T70, TM-P60**



## TM-J2000/J2100

With UPC-E (m = 1, 66), 11 or 12 bytes can be used for the amount of data to process. Only capital letters (ASCII = A ~ D/Hexadecimal = 41H ~ 44H/Decimal = 65 ~ 68) can be used for the start/stop character with CODABAR (m = 6, 71).

## TM-T90, TM-L90

With UPC-E (m = 1, 66), 11 or 12 bytes can be used for the amount of data to process. Only capital letters (ASCII = A ~ D/Hexadecimal = 41H ~ 44H/Decimal = 65 ~ 68) can be used for the start/stop character with CODABAR (m = 6, 71).

When printing ladder bar code (bar code rotated by 90 degrees in page mode) the printer starts actual printing after it reaches control speed for printing ladder bar code. It is needed to feed paper amount of 10 dots or less in this operation.

If the memory switch [Msw 8-5] is ON, the printer inserts a space data automatically. Therefore, the print area is [bar code data + space of the dots as following table] when executing this command.

Model	Right spacing	Left spacing	Notes
TM-T90 (other than Japanese model)	15 dots	15 dots	15 dots = approximately 2.12 mm [15/180 inch]
TM-T90 (Japanese model)	19 dots	19 dots	19 dots = approximately 2.38 mm [19/180 inch]
TM-L90	19 dots	19 dots	19 dots = approximately 2.38 mm [19/180 inch]

## TM-T88IV, TM-T70

With UPC-E (m = 1, 66), 11 or 12 bytes can be used for the amount of data to process. Only capital letters (ASCII = A ~ D/Hexadecimal = 41H ~ 44H/Decimal = 65 ~ 68) and small letters (ASCII = a ~ d/Hexadecimal = 61H ~ 64H/Decimal = 97 ~ 100) can be used for the start/stop character with CODABAR (m = 6, 71).

## TM-P60

With UPC-E (**m** = 1, 66), 6, 7, 8, 11 or 12 bytes can be used for the amount of data to process.

Only capital letters (ASCII = A ~ D/Hexadecimal = 41H ~ 44H/Decimal = 65 ~ 68) and small letters (ASCII = a ~ d/Hexadecimal = 61H ~ 64H/Decimal = 97 ~ 100 ) can be used for the start/stop character with CODABAR (**m** = 6, 71).

When printing ladder bar code (bar code rotated by 90 degrees in page mode), it is printed with the "printing control mode = fine" regardless of the setting of Function 48 of **GS ( K**.

## GS w

[Name]	Set bar code width
[Format]	ASCII    GS w <b>n</b> Hex      1D 77 <b>n</b> Decimal  29 119 <b>n</b>
[Range]	<b>TM-J2000/J2100: <math>2 \leq n \leq 6</math>, <math>68 \leq n \leq 76</math></b> <b>TM-T90, TM-T88IV, TM-T70, TM-L90, TM-P60: <math>2 \leq n \leq 6</math></b>
[Default]	<b>TM-J2000/J2100, TM-T90, TM-T88IV, TM-T70, TM-L90, TM-P60: <math>n = 3</math></b>
[Printers not featuring this command]	<b>TM-U230, TM-U220</b>
[Description]	Sets the horizontal size of a bar code. <ul style="list-style-type: none"> <li>• <b>n</b> specifies the bar code module width.</li> </ul>
[Notes]	<ul style="list-style-type: none"> <li>■ The units for <b>n</b> depend on the printer model.</li> <li>■ This command setting is effective until performing of <b>ESC @</b>, reset or power-off.</li> <li>■ Bar code types are Multi level bar code [UPC-A, UPC-E, JAN13 / EAN13, JAN8 / EAN8, CODE93, CODE128, UCC/EAN128, RSS-14, RSS-14 Truncated, RSS Limited, and RSS Expanded] and Binary level bar code [CODE39, ITF, CODABAR(NW-7)].</li> </ul>

[Model-dependent variations]

**TM-J2000/J2100, TM-T90, TM-T70, TM-T88IV, TM-L90, TM-P60**

## Program Example for all printers

```

PRINT #1, CHR$(&H1D);"h";CHR$(80); ←Set height
PRINT #1, CHR$(&H1D);"w";CHR$(3); ←Set width size to 3
PRINT #1, CHR$(&H1D);"k";CHR$(2); ←Print bar code
PRINT #1, "496595707379";CHR$(0);
PRINT #1, CHR$(&HA);
PRINT #1, CHR$(&H1D);"w";CHR$(4); ←Set width size to 4
PRINT #1, CHR$(&H1D);"k";CHR$(2); ←Print bar code
PRINT #1, "496595707379";CHR$(0);
PRINT #1, CHR$(&HA);
PRINT #1, CHR$(&H1D);"w";CHR$(5); ←Set width size to 5
PRINT #1, CHR$(&H1D);"k";CHR$(2); ←Print bar code
PRINT #1, "496595707379";CHR$(0);
    
```

## Print Sample



## TM-J2000/J2100

The module width differs, depending on the specification. (Unit: mm)

n	Module width (mm) for multilevel bar code	Binary level bar code	
		Thin element width (mm)	Thick element width (mm)
2, 68	0.282 {0.011 inch}	0.282 {0.011 inch}	0.706 {0.028 inch}
69	0.353 {0.014 inch}	0.353 {0.014 inch}	0.918 {0.036 inch}
3, 70	0.423 {0.017 inch}	0.423 {0.017 inch}	1.129 {0.044 inch}
71	0.494 {0.019 inch}	0.494 {0.019 inch}	1.271 {0.050 inch}
4, 72	0.564 {0.022 inch}	0.564 {0.022 inch}	1.411 {0.056 inch}
73	0.635 {0.025 inch}	0.635 {0.025 inch}	1.624 {0.064 inch}
5, 74	0.706 {0.028 inch}	0.706 {0.028 inch}	1.834 {0.072 inch}
75	0.776 {0.031 inch}	0.776 {0.031 inch}	2.047 {0.077 inch}
6, 76	0.847 {0.033 inch}	0.847 {0.033 inch}	2.258 {0.089 inch}

# CONFIDENTIAL

## TM-T90, TM-T70

The module width differs, depending on the specification. (Unit: mm)

<Other than Japanese model>

n	Module width (mm) for multilevel bar code	Binary level bar code	
		Thin element width (mm)	Thick element width (mm)
2	0.282 {0.011 inch}	0.282 {0.011 inch}	0.706 {0.028 inch}
3	0.423 {0.017 inch}	0.423 {0.017 inch}	1.129 {0.044 inch}
4	0.564 {0.022 inch}	0.564 {0.022 inch}	1.411 {0.056 inch}
5	0.706 {0.028 inch}	0.706 {0.028 inch}	1.834 {0.072 inch}
6	0.847 {0.033 inch}	0.847 {0.033 inch}	2.258 {0.089 inch}

<Japanese model>

n	Module width (mm) for multilevel bar code	Binary level bar code	
		Thin element width (mm)	Thick element width (mm)
2	0.250	0.250	0.625
3	0.375	0.375	1.000
4	0.500	0.500	1.250
5	0.625	0.625	1.625
6	0.750	0.750	2.000

## TM-T88IV

The module width differs, depending on the specification. (Unit: mm):

n	Module width (mm) for multilevel bar code	Binary level bar code	
		Thin element width (mm)	Thick element width (mm)
2	0.282 {0.011 inch}	0.282 {0.011 inch}	0.706 {0.028 inch}
3	0.423 {0.017 inch}	0.423 {0.017 inch}	1.129 {0.044 inch}
4	0.564 {0.022 inch}	0.564 {0.022 inch}	1.411 {0.056 inch}
5	0.706 {0.028 inch}	0.706 {0.028 inch}	1.834 {0.072 inch}
6	0.847 {0.033 inch}	0.847 {0.033 inch}	2.258 {0.089 inch}

## TM-L90, TM-P60

The module width differs, depending on the specification. (Unit: mm)

n	Module width (mm) for multilevel bar code	Binary level bar code	
		Thin element width (mm)	Thick element width (mm)
2	0.250	0.250	0.625
3	0.375	0.375	1.000
4	0.500	0.500	1.250
5	0.625	0.625	1.625
6	0.750	0.750	2.000

## MACRO FUNCTION COMMANDS

---

Command	Name
---------	------

<b>GS :</b>	Start/end macro definition
<b>GS ^</b>	Execute macro

## GS :

[Name] Start/end macro definition

[Format] ASCII GS :  
Hex 1D 3A  
Decimal 29 58

[Range] None

[Default] None

[Printers not featuring this command] **TM-T70**, **TM-P60**, **TM-U230**, **TM-U220**

[Description] Starts or ends macro definition.

- [Notes]
- Macro definition starts when this command is processed during normal operation and ends when it is processed during macro definition.
  - While the macro is defined, the printing is also executed.
  - The maximum number of data to be defined as a macro is different, depending on the printer model. If the macro definition exceeds the maximum number of data, the excess data is not stored.
  - If the printer processes this command again immediately after previously processing it, the printer clears the definition.
  - Macro is not defined when the power is turned on.
  - The defined contents of the macro are not cleared by **ESC @**. Defined content of the macro is effective until the printer is reset, or the power is turned off.
  - The macro is executed by **GS ^**.
  - The following commands cannot be contained in a macro. Do not use these commands while the macro is being defined.  
**GS ( A**, **GS ( C** (part of functions), **GS ( E** (part of functions), **GS ( L / GS 8 L** (part of functions), **GS ( M** (part of functions), **GS Q 0**, **GS ^**, **GS g 0**, **GS v 0**, **FS g 1**, **FS q**.

[Model-dependent variations] **TM-J2000/J2100**, **TM-T90**, **TM-T88IV**, **TM-L90**

See program example and print sample for **GS :** and **GS ^**.



# CONFIDENTIAL

**TM-J2000/J2100, TM-T90, TM-T88IV, TM-L90**

**The maximum number of data to be defined is 2048 bytes.**

[Name]	Execute macro																		
[Format]	<table border="0"> <tr> <td>ASCII</td> <td>GS</td> <td>^</td> <td><b>r</b></td> <td><b>t</b></td> <td><b>m</b></td> </tr> <tr> <td>Hex</td> <td>1D</td> <td>5E</td> <td><b>r</b></td> <td><b>t</b></td> <td><b>m</b></td> </tr> <tr> <td>Decimal</td> <td>29</td> <td>94</td> <td><b>r</b></td> <td><b>t</b></td> <td><b>m</b></td> </tr> </table>	ASCII	GS	^	<b>r</b>	<b>t</b>	<b>m</b>	Hex	1D	5E	<b>r</b>	<b>t</b>	<b>m</b>	Decimal	29	94	<b>r</b>	<b>t</b>	<b>m</b>
ASCII	GS	^	<b>r</b>	<b>t</b>	<b>m</b>														
Hex	1D	5E	<b>r</b>	<b>t</b>	<b>m</b>														
Decimal	29	94	<b>r</b>	<b>t</b>	<b>m</b>														
[Range]	<p><math>1 \leq \mathbf{r} \leq 255</math>  <math>0 \leq \mathbf{t} \leq 255</math>  <math>\mathbf{m} = 0, 1</math></p>																		
[Default]	None																		
[Printers not featuring this command]	<b>TM-T70</b> , <b>TM-P60</b> , <b>TM-U230</b> , <b>TM-U220</b>																		
[Description]	<p>Executes a macro <b>r</b> times while waiting <b>t</b> × 100 msec for each macro execution, using the mode specified by <b>m</b> as follows:</p> <ul style="list-style-type: none"> <li>• When <b>m</b> = 0, the macro executes <b>r</b> times continuously at the interval specified by <b>t</b>.</li> <li>• When <b>m</b> = 1, the printer waits for the period specified by <b>t</b>, flashes the LED, and then waits for the paper feed button to be pressed. After this button is pressed, the printer executes the macro once. The printer repeats this operation <b>r</b> times.</li> </ul>																		
[Notes]	<ul style="list-style-type: none"> <li>■ If a macro is not defined or if <b>r</b> is 0, this command is ignored.</li> <li>■ Even if the panel buttons are disabled by <b>ESC C 5</b>, the paper feed button will be enabled temporarily while the printer is waiting for the buttons to be pressed when execution mode by button (<b>m</b> = 1) is specified. However, paper cannot be fed if the paper feed button is pressed. When the paper feed button is pressed, if <b>DLE ENQ</b> (<b>n</b> = 0) is processed, the printer performs in the same way as if the button were pressed once.</li> <li>■ The waiting status for the paper feed to be pressed can be checked by <b>DLE EOT</b> (<b>n</b> = 1: Printer status) or basic ASB status.</li> <li>■ If this command is processed while a macro is being defined, the printer cancels macro definition and clears the definition.</li> <li>■ This command cannot be contained in the macro. Do not use this command when the macro is defined.</li> <li>■ The LED and the paper feed button are different, depending on the printer model.</li> </ul>																		

- The macro is defined by **GS :**
- Macro function is useful to print the same data repeatedly. To define a macro definition, send **GS :** just before and after the data desired to be repeated. And then execute macro by using **GS ^** to print the same data repeatedly. Macro function eliminates the need for sending all the print data every time.

[Model-dependent variations]

**TM-J2000/J2100**, **TM-T90**, **TM-T88IV**, **TM-L90**

## Program example for GS : and GS ^

### Program Example

```
PRINT #1, CHR$(&H1D);": ";
PRINT #1, CHR$(&H1B);"a";CHR$(1);
PRINT #1, "*** Hello";
PRINT #1, CHR$(&H1D);"!";CHR$(17);
PRINT #1, "EPSON";
PRINT #1, CHR$(&H1D);"!";CHR$(0);
PRINT #1, "World! ***";
PRINT #1, CHR$(&HA); CHR$(&HA);
PRINT #1, CHR$(&H1B);"a";CHR$(0);
PRINT #1, CHR$(&H1B);"-";CHR$(1);
PRINT #1, "No.                "; CHR$(&HA);
PRINT #1, "Name                "; CHR$(&HA);
PRINT #1, "Address                "; CHR$(&HA);
PRINT #1, CHR$(&H1B);"d";CHR$(5);
PRINT #1, CHR$(&H1B);"-";CHR$(0);
PRINT #1, CHR$(&H1D);": ";
PRINT #1, CHR$(&H1D);"^";CHR$(2);CHR$(0);CHR$(0);
```

Defines  
a macro

### Print Sample

```
***Hello EPSON World! ***
No. _____
Name _____
Address _____

***Hello EPSON World! ***
No. _____
Name _____
Address _____
```

## TM-J2000/J2100

When **m = 1**, the PAPER OUT LED indicator blinks during a macro waiting state.

When **m = 1**, the PAPER FEED can be Paper feed button.

# C O N F I D E N T I A L

## **TM-T90, TM-T88IV, TM-L90**

When **m = 1**, the PAPER OUT LED indicator blinks during a macro waiting state.

When **m = 1**, the FEED can be Paper feed button.

## MECHANISM CONTROL COMMANDS

**Command**   **Name**

---

<b>ESC &lt;</b>	Return home
<b>ESC U</b>	Turn unidirectional print mode on/off
<b>ESC i</b>	Partial cut (one point left uncut)
<b>ESC m</b>	Partial cut (three points left uncut)
<b>GS V</b>	Select cut mode and cut paper

## ESC <

[Name]	Return home
[Format]	ASCII    ESC < Hex      1B 3C Decimal  27 60
[Range]	None
[Default]	None
[Printers not featuring this command]	<b>TM-T90</b> , <b>TM-T88IV</b> , <b>TM-T70</b> , <b>TM-L90</b> , <b>TM-P60</b>
[Description]	Moves the print head to the standby position.
[Notes]	<ul style="list-style-type: none"> <li>■ The standby position is different, depending on the printer model.</li> <li>■ The command rechecks the standby position; therefore, the print position might be shifted before and after checking the standby position.</li> </ul>
[Model-dependent variations]	<b>TM-J2000/J2100</b> , <b>TM-U230</b> , <b>TM-U220</b>

**Program Example for all printers**

```
PRINT #1, CHR$(&H1B); "<" ;
```

### **TM-J2000/J2100**

**The standby position is on the right.**

### **TM-U230**

**The standby position is on the left.**

### **TM-U220**

**The standby position is on the left.**

## ESC U

[Name] Turn unidirectional print mode on/off

[Format]      ASCII      ESC U    **n**  
                  Hex        1B 55    **n**  
                  Decimal    27 85    **n**

[Range]         $0 \leq n \leq 255$

[Default]      **n** = 0

[Printers not featuring this command] **TM-T90**, **TM-T88IV**, **TM-T70**, **TM-L90**, **TM-P60**

[Description]    Turns unidirectional print mode on or off.

- When the LSB of **n** is 0, unidirectional print mode is turned off.
- When the LSB of **n** is 1, unidirectional print mode is turned on.

- [Notes]
- This mode can be set independently in standard mode and in page mode.
    - When this command is used in standard mode, the printer sets the mode for standard mode.
    - When this command is used in page mode, the printer sets the mode for page mode.
  - When unidirectional print mode is turned off, bidirectional print mode is automatically turned on.
  - When page mode is selected, the printer performs unidirectional printing for all data that is to be collectively printed using **FF** or **ESC FF**.
  - Unidirectional print mode can be turned on when printing double-height characters or graphics or bit image or two dimension code to ensure that the top and bottom of the printing patterns are aligned.
  - The settings of this command are effective until **ESC @** is executed, the printer is reset, or the power is turned off.

[Model-dependent variations]      None

**Program Example for all printers**

```
PRINT #1, CHR$( &H1B ); "U"; CHR$( 1 ); ← Unidirectional print mode turned on
```

## ESC i

[Name] Partial cut (one point left uncut)

[Format] ASCII ESC i  
Hex 1B 69  
Decimal 27 105

[Range] None

[Default] None

[Printers not featuring this command] **TM-J2000/J2100**, **TM-T90**, **TM-T70**, **TM-L90**, **TM-P60**, **TM-U230**

[Description] Executes a partial cut of the roll paper.

[Recommended Functions]

This command is supported by some printer models but will not be supported by future printer models. **GS V** is recommended for cutting paper. **GS V** <Function A> gives the same result as this command.

[Notes] ■ See **GS V** <Function A> for details.

■ The cutting shape depends on the specification of the mounted autocutter.

[See program example and print sample for ESC i and ESC m.](#)

[Model-dependent variations] **TM-T88IV**, **TM-U220**

### **TM-T88IV**

**The distance from print head to autocutter is about 15 mm {0.59 inch}.**

**After executing a paper cut, a paper feed for 1 mm {14/360 inches} before starting the next printing can provide the best printing result without uneven paper feeding.**

### **TM-U220**

**This printer may make "dot displacement" after autocutting. It is recommended to feed approximately 2.116 mm or more for printing the next line to prevent "dot displacement after cutting."**



# C O N F I D E N T I A L

Since the **TM-U220D** is not equipped with an autocutter, this command is ignored by **TM-U220D**.  
The setting is partial cut (one point is left) when the printer is shipped.  
The distance from print head to autocutter is about 27 mm {1.06 inches} in the **TM-U220A** and **TM-U220B**.

## ESC m

[Name] Partial cut (three points left uncut)

[Format] ASCII ESC m  
 Hex 1B 6D  
 Decimal 27 109

[Range] None

[Default] None

[Printers not featuring this command] **TM-J2000/J2100**, **TM-T90**, **TM-T70**, **TM-L90**, **TM-P60**, **TM-U230**

[Description] Executes a partial cut of the roll paper.

[Recommended Functions]

This command is supported by some printer models but will not be supported by future printer models.

**GS V** is recommended for cutting paper. **GS V** <Function A> gives the same result as this command.

[Notes] ■ See **GS V** <Function A> for details.

■ The cutting shape depends on the specification of the mounted autocutter.

[Model-dependent variations] **TM-T88IV**, **TM-U220**

# CONFIDENTIAL

## Program example for ESC i and ESC m

### Program Example

```
PRINT #1, "    AAAAA";  
PRINT #1, CHR$(&H1B); "d"; CHR$(5);  
PRINT #1, CHR$(&H1B); "m"; ←Cut paper  
PRINT #1, "    BBBBB";  
PRINT #1, CHR$(&H1B); "d"; CHR$(5);  
PRINT #1, CHR$(&H1B); "m"; ←Cut paper
```

### Print Sample

AAAAA  
ESC m leaves paper joined in three places.

BBBBB  
ESC i leaves paper joined in one place.

### TM-T88IV

The distance from print head to autocutter is about 15 mm {0.59 inch}.

After executing a paper cut, a paper feed for 1 mm {14/360 inches} before starting the next printing can provide the best printing result without uneven paper feeding.

### TM-U220

Uneven pitch may occur with subsequent paper feed due to the operation of the autocutter. It is recommended to feed approximately 2.116 mm or more for printing the next line to prevent "dot displacement after cutting."

Since the **TM-U220D** is not equipped with an autocutter, this command is ignored by the **TM-U220D**.

The setting is partial cut (one point is left) when the printer is shipped.

The distance from print head to autocutter is about 27 mm {1.06 inches} in the **TM-U220A** and **TM-U220B**.

## GS V

[Name]	Select cut mode and cut paper					
[Format]	Function A	ASCII	GS	V	<b>m</b>	
		Hex	1D	56	<b>m</b>	
		Decimal	29	86	<b>m</b>	
	Function B	ASCII	GS	V	<b>m</b>	<b>n</b>
		Hex	1D	56	<b>m</b>	<b>n</b>
		Decimal	29	86	<b>m</b>	<b>n</b>
	Function C	ASCII	GS	V	<b>m</b>	<b>n</b>
		Hex	1D	56	<b>m</b>	<b>n</b>
		Decimal	29	86	<b>m</b>	<b>n</b>
	Function D	ASCII	GS	V	<b>m</b>	<b>n</b>
		Hex	1D	56	<b>m</b>	<b>n</b>
		Decimal	29	86	<b>m</b>	<b>n</b>
[Range]	<p><b>TM-J2000/J2100, TM-T90, TM-T88IV, TM-T70, TM-U220:</b>  <b>Function Am = 0, 1, 48, 49</b>  <b>Function Bm = 65, 66; 0 ≤ n ≤ 255</b></p> <p><b>TM-L90:</b>  <b>With Peeler:</b>  <b>Does not support this command.</b>  <b>TM-L90 models without Peeler:</b>  <b>Function Am = 0, 1, 48, 49</b>  <b>Function Bm = 65, 66; 0 ≤ n ≤ 255</b>  <b>Function Dm = 103, 104; 0 ≤ n ≤ 255</b>  <b>(Function B and D can be used when the paper layout is specified as "paper layout is not used.")</b></p> <p><b>TM-P60:</b>  <b>With Peeler:</b>  <b>Function B m = 65, 66; 0 ≤ n ≤ 255</b>  <b>TM-P60 models without Peeler:</b>  <b>Function Am = 0, 1, 48, 49</b>  <b>Function Bm = 65, 66; 0 ≤ n ≤ 255</b></p>					

**TM-U230:**    **Function Am = 1, 49**  
                   **Function Bm = 66; 0 ≤ n ≤ 255**  
                   **Function Cm = 66; 0 ≤ n ≤ 255**

[Default]            None

[Printers not featuring this command] None

[Description]        Executes paper cutting specified by **m**, as follows:

<b>m</b>	<b>Function</b>
<A>	0, 48    Executes a full cut (cuts the paper completely).
	1, 49    Executes a partial cut (one point left uncut).
<B>	65       Feeds paper to (cutting position + <b>n</b> × vertical motion unit) and executes a full cut (cuts the paper completely).
	66       Feeds paper to (cutting position + <b>n</b> × vertical motion unit) and executes a partial cut (one point left uncut).
<C>	97       Specifies a paper cutting range to (basic paper feed amount + [ <b>n</b> × vertical motion unit] and executes a full cut.
	98       Specifies a paper cutting range to (basic paper feed amount + [ <b>n</b> × vertical motion unit] and executes a partial cut (one point left uncut).
<D>	103      Feeds paper to (cutting position + <b>n</b> × vertical motion unit) and executes a full cut (cuts the paper completely), then feeds paper to the print start position.
	104      Feeds paper to (cutting position + <b>n</b> × vertical motion unit) and executes a partial cut (one point left uncut), then feeds paper to the print start position.

- **n** of <B> and <D> specify paper feed amount executed immediately before a paper cut.
- **n** of <C> specifies a range of paper cut.

[Notes for <A>, <B>, <C>, and <D>]

- When standard mode is selected, these commands are enabled only when processed at the beginning of the line.

- When using these commands, there is a gap between the cutting position and the print position.
- [Note for <A>]
- If an autocutter is provided, this command can be used.
- [Notes for <B>]
- When **n** = 0, the printer feeds the paper to the cutting position and cuts it.
  - If an autocutter is not provided, the printer only feeds the paper for specified amount.
  - Vertical motion unit is used for calculating a paper feed amount.
- [Notes for <C>]
- Vertical motion unit is used for calculating a paper feed amount.
  - Basic paper feed amount differs, depending on the models.
  - Paper is fed for the same amount as a cutting range when processing this function.
  - The paper will not be cut when this command is executed. When a cutting position reaches an autocutter position after printing and feeding the next receipt, the printer executes a cutting.
  - When a cutting range specified is larger than a top margin (physical distance between the autocutter and print head), the cutting range is forced to be the amount of the top margin.
  - It is possible to set multiple cutting ranges.
  - Even if the cutting is set to be large, only one cutting will be executed for each cutting range.
  - The cutting range specified is effective until a paper cut is executed, **ESC @** is executed, the printer is reset, or the power is turned off.
  - If an autocutter is provided, this command can be used.
  - The function makes it possible to save paper by reducing the top margin for continuous printing.
- [Notes for <D>]
- If an autocutter is provided, this command can be used.
  - When **n** = 0, the printer feeds the paper to the cutting position and cuts it.
  - Vertical motion unit is used for calculating a paper feed amount.
  - The function makes it possible to save paper by reducing the top margin for continuous printing.

# CONFIDENTIAL

[Model-dependent variations]

**TM-J2000/J2100**, **TM-T90**, **TM-T88IV**, **TM-T70**, **TM-L90**, **TM-P60**, **TM-U230**,  
**TM-U220**

## Program Example for all printers

```
PRINT #1, "      AAAAA"; CHR$(65);  
PRINT #1, CHR$(65);CHR$(66);CHR$(0); ←Feed paper and cut
```

## Print Sample

```
      AAAAA  
-----  
Paper fed to the cutting position and  
partial cut (one point left uncut)  
performed
```

## TM-J2000/J2100

The vertical motion unit is specified by **GS P**.

The cutting shapes of (**m = 0,48**) and (**m = 1,49**) are the same as the cutting shape of (**m = 65**) and (**m = 66**). Whether the operation is a full cut or a partial cut (one point is left) is determined by the installation position of the autocutter. The distance from print head to autocutter is about 24.5 mm {1 inch}.

## TM-T90

The vertical motion unit is specified by **GS P**.

The cutting shapes of (**m = 0,48**) and (**m = 1,49**) are the same as the cutting shape of (**m = 65**) and (**m = 66**). The setting is partial cut (one point is left) when the printer is shipped. It can be changed to full cut setting by dealer's option. The distance from print head to the autocutter is about 14 mm {0.55 inch}.

After executing a paper cut, a paper feed for 1 mm {other than Japanese specifications:14/360 inches/Japanese specification:16/406 inches} before starting the next printing can provide the best printing result without uneven paper feeding. If the printer is left until the next printing after executing a paper cut, feeding paper more than 1 mm can avoid a paper jam inside the autocutter.

## TM-L90

**TM-L90 with Peeler:**

The printer does not support this command.

## **TM-L90 models without Peeler:**

The vertical motion unit is specified by **GS P**.

The cutting shapes of (**m = 0,48**) and (**m = 1,49**) are the same as the cutting shape of (**m = 65**) (**m = 66**), (**m = 103**) and (**m = 104**). The setting is full cut when the printer is shipped. It can be changed to partial cut (one point is left) setting by dealer's option. Don't use Function <D> after changing the setting to partial cut.

Whether the operation is a full cut or a partial cut (one point is left) is determined by the installation position of the autocutter. When selecting paper layout (origin of layout) as "bottom of a label" or "top of a black mark," use this command immediately after executing the paper feed to the cutting position. The distance from print head to autocutter is about 14 mm {0.55 inch}. The top margin is about 3 mm {0.12 inch} when executing Function <D>.

After executing a paper cut, a paper feed for 1 mm {16/406 inches} before starting the next printing can provide the best printing result without uneven paper feeding. If the printer is left until the next printing after executing a paper cut, feeding paper more than 1 mm {16/406 inches} can avoid a paper jam inside the autocutter.

## **TM-P60**

The vertical motion unit is approximately 0.125 mm {1/203 inches}. This value equals one dot pitch.

### **With Peeler**

This command operates when paper layout [layout reference (**sm = "0"**)] is specified. See **FS ( L <Function 33>** for paper layout.

This printer does not have an autocutter, so the paper is not cut. After executing [manual cutter position + (**n** × about 0.125 mm {1/203 inch})] paper feed with <Function B>, pull the paper and cut it.

### **TM-P60 models without Peeler**

The cutting shapes of (**m = 0,48**) and (**m = 1,49**) are the same as the cutting shape of (**m = 65**) and (**m = 66**). The setting is partial cut (one point is left uncut). The distance from print head to the autocutter is about 6.4 mm.



## TM-T88IV

The vertical motion unit is specified by **GS P**.

The distance from print head to autocutter is about 15 mm {0.59 inch}.

After executing a paper cut, a paper feed for 1 mm {14/360 inches} before starting the next printing can provide the best printing result without uneven paper feeding.

## TM-T70

The vertical motion unit is specified by **GS P**.

The distance from print head to autocutter is about 13 mm {0.51 inch}.

After executing a paper cut, a paper feed for 1 mm {other than Japanese specifications:7/180 inches/Japanese specification:8/203 inches} before starting the next printing can provide the best printing result without uneven paper feeding.

## TM-U230

The vertical motion unit is approximately 0.176 mm {1/144 inch}. This equals 1/2 dot pitch.

When using Function C, the basic unit is approximately 4 mm {0.16 inch}. The top margin is approximately 27 mm {1.06 inches}.

## TM-U220

Uneven pitch may occur with subsequent paper feed due to the operation of the autocutter. It is recommended to feed approximately 2.116 mm or more for printing the next line to prevent "dot displacement after cutting."

Since **TM-U220D** is not equipped with an autocutter, it can use only Function B. The printer feeds paper for [manual cutter position + ( $n \times$  approximately 0.176 mm {1/144 inch})].

The cutting shapes of ( $m = 0,48$ ) and ( $m = 1,49$ ) are the same as the cutting shape of ( $m = 65$ ) and ( $m = 66$ ). The setting is partial cut (one point is left) when the printer is shipped.

The distance from print head to autocutter is about 27 mm {1.06 inches} in the **TM-U220A** and **TM-U220B**. The distance from print head to emergency cutter is about 22.1 mm {0.87 inch} in **TM-U220D**.

## MISCELLANEOUS COMMANDS

**Command Name**

<b>DLE ENQ</b>	Send real-time request to printer
<b>DLE DC4 (fn = 1)</b>	Generate pulse in real-time
<b>DLE DC4 (fn = 2)</b>	Execute power-off sequence
<b>DLE DC4 (fn = 7)</b>	Transmit specified status in real time
<b>DLE DC4 (fn = 8)</b>	Clear buffer (s)
<b>ESC ( A</b>	Control beeper tones
	Beep integrated beeper in <b>TM-U230</b> models
	Set integrated beeper when offline factors occur in <b>TM-U230</b> models
	Set integrated beeper except when offline factors occur in <b>TM-U230</b> models
<b>ESC =</b>	Select peripheral device
<b>ESC @</b>	Initialize printer
<b>ESC L</b>	Select page mode
<b>ESC S</b>	Select standard mode
<b>ESC p</b>	Generate pulse
<b>GS ( A</b>	Execute test print
<b>GS ( D</b>	Enable/disable real-time command
<b>GS ( H</b>	Request transmission of response or status
<b>GS ( K</b>	Select print control method(s)
	Select the print control mode
	Select the print density
	Select the print speed
	Select the number of parts for the thermal head energizing
<b>GS ( P</b>	Page mode control
	Printable area setting when page mode is selected
<b>GS ( Q</b>	Commands for drawing graphics
	Draw line
	Draw rectangle

# CONFIDENTIAL

<b>GS I</b>	Transmit printer ID
<b>GS P</b>	Set horizontal and vertical motion units
<b>GS g 0</b>	Initialize maintenance counter
<b>GS g 2</b>	Transmit maintenance counter
<b>GS z 0</b>	Set online recovery wait time
<b>GS z 0 (TM-L90 with Peeler)</b>	Set online recovery wait time

## DLE ENQ

[Name] Send real-time request to printer

[Format] ASCII DLE ENQ **n**  
 Hex 10 05 **n**  
 Decimal 16 5 **n**

[Range] **TM-J2000/J2100, TM-T90, TM-L90: 0 ≤ n ≤ 2**  
**TM-T88IV: n = 1, 2**  
**TM-T70, TM-P60, TM-U220: n = 2**  
**TM-U230: n = 0, 2**

[Default] None

[Printers not featuring this command] None

[Description] Responds to a request in real time from the host computer, using **n** as follows:

<b>n</b>	<b>Request</b>
0	Recovers to online status when following online recovery waiting status. In the waiting status for the button to be pressed, the printer operates in the same way as when the FEED button is pressed once.
1	Recovers from a recoverable error and restarts printing from the line where the error occurred.
2	Recovers from a recoverable error after clearing the receive and print buffers.

- [Notes]
- This is a real-time command that the printer executes upon receiving it. Note the following when using this command.
    - If this command is embedded within the code string of another command, it is processed as a parameter of the other command, and the print result is not correct.
    - If another command (such as graphics data or defined data) has a code string in a parameter that is the same as this command, the printer starts processing this command.
  - The request of **n = 0** can be used in the following online recovery waiting status.
    - The roll paper is installed in **TM-U230** (See **GS z 0**.)

- Online recovery for the **TM-L90** with Peeler (See GS z 0 (Peeler).)
- Status waiting for the button to be pressed, while **GS ^** is executed.
- (**n = 1**) or (**n = 2**) is enabled when a recoverable error occurs with the exception of an automatically recoverable error, and is ignored in other cases. Errors recoverable by (**n = 1**) or (**n = 2**) depend on the printer model.
- Even if the printer is disabled by **ESC =**, this command can be used.
- With a serial interface model, this command is executed even when the printer is offline or the receive buffer is full.
- With a parallel interface model, this command is not executed in the following statuses, because the printer is busy and unable to receive data from the host computer. The DIP switch (BUSY condition) is different, depending on the printer model.
  - Receive buffer is full when DIP switch is set to On.
  - Printer is offline or receive buffer is full when DIP switch is set to Off.
- When a recoverable error occurs, after removing the cause of the error, the printer can recover from the error by transmitting **DLE ENQ 1** or **DLE ENQ 2** without the printer being turned off.
- **DLE ENQ 1** or **DLE ENQ 2** is enabled only when a recoverable error occurs, with the exception of an automatically recovered error, and is ignored in other cases. Errors recoverable by **DLE ENQ 1** or **DLE ENQ 2** depend on the printer model.
- **DLE ENQ 1** or **DLE ENQ 2** is also executed to recover from a recoverable error when the printer is disabled by **ESC =**.
- In page mode, if the printer recovers from a recoverable error by using **DLE ENQ 2**, the printer returns to standard mode after clearing the data in receive and print buffers and changing the values set by **ESC W** to the default values.
- After processing **DLE ENQ 2**, the print position is moved to the left side of the printable area. Printer is in the status "beginning of the line," or "there is not data in the print buffer."
- This command is disabled while sending the block data "Header ~ NUL."

[Model-dependent variations]

**TM-J2000/J2100**, **TM-T90**, **TM-T88IV**, **TM-T70**, **TM-L90**, **TM-U230**, **TM-U220**.

**Program Example for all printers**

```
PRINT #1, CHR$( &H10 ); CHR$( &H5 ); CHR$( 2 );
```

**TM-J2000/J2100, TM-T90**

**BUSY condition is selected by memory switch [Msw1-3].**

**TM-T88IV, TM-T70**

**BUSY condition for a parallel interface is selected by DIP switch 2-1.**

**TM-L90**

**TM-L90 with Peeler:**

**BUSY condition is selected by memory switch [Msw1-3].**

The settings of [Msw8-1] and [Msw8-2] affect the recovery operation from the paper layout error. See Function 3 of GS ( E.

[Msw8-1][Msw8-2]	Recovery operation from error
OFF	When the printer recovers from the error, paper layout is measured automatically and paper is fed to the label print starting position and the paper layout stored in the non-volatile memory is rewritten. Afterwards, the printer operates following the paper layout automatically measured. When the peeling issuing mode is selected, the printer is in the waiting status for a label to be removed when the paper layout is automatically measured; therefore operators should remove the label.
ON	When the printer recovers from the error, paper is fed to the label print starting position. Paper layout stored in the non-volatile memory is not changed. Change the setting of the paper layout stored in the non-volatile memory so that it matches the currently used paper layout. See function 49 of this command for setting the paper layout.

Request of (n=0) can be used when GS ^ is executed or when the printer is in one of the following status conditions when the peeling issuing mode is selected:

- Waiting for the paper feed button to be pressed when the cover is closed.
- Waiting for the paper feed button to be pressed to remove a label (when the label peeling detector cannot detect paper due to sunlight).

**TM-L90 models without Peeler:**

**BUSY condition is selected by memory switch [Msw1-3].**

The setting of [Msw8-2] affects the recovery operation from the paper layout error. See Function 3 of GS ( E.

[Msw8-2]	Recovery operation from error
OFF	When the printer recovers from the error, paper layout is measured automatically and paper is fed to the label print starting position and the paper layout stored in the non-volatile memory is rewritten. Afterwards, the printer operates following the paper layout automatically measured.
ON	When the printer recovers from the error, paper is fed to the label print starting position. Paper layout stored in the non-volatile memory is not changed. Change the setting of the paper layout stored in the non-volatile memory so that it matches the currently used paper layout. See function 49 of this command for setting the paper layout.

**TM-U230, TM-U220**

**BUSY condition for the parallel interface is selected by DIP switch 1-8.**



## DLE DC4 (*fn* = 1)

[Name] Generate pulse in real-time

[Format] ASCII DLE DC4 **n** **m** **t**  
 Hex 10 14 **n** **m** **t**  
 Decimal 16 20 **n** **m** **t**

[Printers not featuring this command] **TM-P60**, **TM-U230**

[Range] **n** = 1  
**m** = 0, 1  
 1 ≤ **t** ≤ 8

[Description] Outputs the pulse specified by **t** to connector pin **m** as follows in real time:

<b>m</b>	Connector pin
0	Drawer kick-out connector pin 2
1	Drawer kick-out connector pin 5

The pulse ON time is [**t** × 100 ms] and the OFF time is [**t** × 100 ms]

- [Notes]
- This is a real-time command that the printer executes upon receiving it. Note the following when using this command.
    - If this command is embedded within the code string of another command, it is processed as a parameter of the other command, and the print result is not correct.
    - If another command (such as graphics data or defined data) has a code string in a parameter that is the same as this command, the printer starts processing this command.
  - This command is ignored in the following states:
    - In error status
    - When the pulse is being output to the connector pin (during processing of **ESC p** and during execution of this command)
    - During transmission of block data (Header ~ NUL)

- When this command is disabled by **GS (D)**
- This command can be used even if the printer is disabled by **ESC =**.
- With a serial interface, the printer executes this command even when it is in offline, receive buffer full.
- With a parallel interface, if the printer is in BUSY condition, this command cannot be used in the following states.
  - When DIP switch (BUSY condition) is on: receive buffer full
  - When DIP switch (BUSY condition) is off: offline, receive buffer full, or error status
- This command is effective when the printer is disabled by **ESC =** (select peripheral device).

[Model-dependent variations]

**TM-J2000/J2100, TM-T90, TM-T88IV, TM-T70, TM-L90, TM-U220**

### Program Example

```
PRINT #1, CHR$( &H10 ); CHR$( &H14 ); CHR$( 1 ) 1 ; CHR$( 0 ); CHR$( 5 );
```

**TM-J2000/J2100, TM-T90, TM-L90**

The **BUSY** condition is selected by memory switch 1-3.

**TM-T88IV, TM-T70**

The **BUSY** condition is selected by memory switch 2-1.

With specifications that have a buzzer, a pulse signal sounds the buzzer with this command. Buzzer control and drawer control is set with the buzzer circuit board DIP switches. Turn off the printer before changing DIP switch settings.

# CONFIDENTIAL

When used together with the UB series with the buzzer function, the buzzer function of the UB series does not operate.

Switch number	Setting	Function
1	OFF	Not use drawer kick connector pin no. 2 for sounding the buzzer
	ON	Use drawer kick connector pin no. 2 for sounding the buzzer
2	OFF	Not use drawer kick connector pin no. 5 for sounding the buzzer
	ON	Use drawer kick connector pin no. 5 for sounding the buzzer

## TM-U220

The BUSY condition is selected by memory switch 1-8.

## DLE DC4 (*fn* = 2)

[Name] Execute power-off sequence

[Format]	ASCII	DLE DC4	<b>fn</b>	<b>a</b>	<b>b</b>
	Hex	10 14	<b>02</b>	<b>a</b>	<b>b</b>
	Decimal	16 20	<b>2</b>	<b>a</b>	<b>b</b>

[Printers not featuring this command] **TM-U230**, **TM-U220**

[Range] **fn** = 2  
**a** = 1  
**b** = 8

[Description] Executes the printer power-off sequence and transmits the power-off notice.

- Saving the maintenance counter values
- Busy controlling for interface
- Changing to waiting state of mechanism

Executes power off processing (this processing depends on printer model).

[Notes]

- This is a real-time command that the printer executes upon receiving it. Note the following when using this command.
  - If this command is embedded within the code string of another command, it is processed as a parameter of the other command, and the print result is not correct.
  - If another command (such as graphics data or defined data) has a code string in a parameter that is the same as this command, the printer starts processing this command.
- This command is ignored in the following states:
  - During transmission of block data (Header ~ NUL)
  - When this command is disabled by **GS (D)**
- With a serial interface, the printer executes this command even when it is in offline, receive buffer full, or error status.

- With a parallel interface, if the printer is BUSY, this command cannot be used in the following states.
  - When DIP switch (BUSY condition) is on: receive buffer full
  - When DIP switch (BUSY condition) is off: offline, receive buffer full, or error status
- This command is effective when the printer is disabled by **ESC =** (select peripheral device).
- All information and data stored in RAM will be deleted by processing this command.
- When the printer has executed setup of power off processing, the printer transmits the power-off notice as shown below to the host.

Power-off notice	Hex	Decimal	Data
Header	3BH	59	1 byte
Identifier	30H	48	1 byte
NUL	00H	0	1 byte

- Maintenance counter values are maintained by executing this command; therefore the maintenance counter values will be more accurate if the user uses this command before turning off the power switch.
- When you use this command, obey the following rules.
  - When host PC transmits the function data, transmit the next data after receiving the corresponding data (header ~ NULL) from the printer.
  - When operating with a serial interface, be sure to configure operation so that the host computer uses the printer only when it is READY.
  - When operating with a parallel interface, the data sent by this function (starting with Header and ending with NUL), as with other data, is first stored in the send buffer, then output in sequential order when the host computer changes to the reverse mode. Note that the send buffer capacity is 99 bytes, and any data exceeding this volume limit will be lost; therefore, when using this command, it is important to configure the operation so that the host computer's change to the reverse mode and the subsequent status send/receive process is performed quickly.

- The power-off notice can be differentiated from other transmission data according to specific data of the transmission data block. When the header transmitted from the printer is [Hex=3BH/Decimal=59], treat NUL [hex = 00H/decimal =0] as a data group and identify it according to the combination of the header and the identifier.

[Model-dependent variations]

**TM-J2000/J2100, TM-T90, TM-L90, TM-T88IV, TM-T70, TM-P60**

## Program Example

```
PRINT #1, CHR$( &H10 ); CHR$( &H14 ); CHR$( 2 ); CHR$( 1 ); CHR$( 8 );  
GOSUB *RECEIVE ← Confirmation "power off notice"
```

### **TM-J2000/J2100, TM-T90, TM-L90**

The **BUSY** condition is selected by memory switch 1-3.

While processing a set up of power-off, the **POWER LED** blinks fast and changes to slow blinking after the printer transmits a power-off notice. Be sure that the **POWER LED** is blinking slowly; then turn off the power switch.

When DIP switch [SW1-1] is ON, the power will not be turned off by this command. Be sure that the power is turned off by an operator.

### **TM-T88IV, TM-T70**

The **BUSY** condition is selected by memory switch 2-1.

The power will not be turned off by this command. Be sure that the power is turned off by an operator.

### **TM-P60**

When memory switch [Msw8-1] is OFF, the power-off notice is not transmitted.

This command processes power-off disconnection.

## DLE DC4 (fn = 7)

[Name] Transmit specified status in real time

ASCIIIDLE	DC4	<b>fn</b>	<b>m</b>	
Hex	10	14	<b>fn</b>	<b>m</b>
Decimal	16	20	<b>fn</b>	<b>m</b>

[Range] **fn = 7**  
**TM-P60: m = 1, 5**

[Printers not featuring this command] **TM-J2000/J2100, TM-T90, TM-T88IV, TM-T70, TM-L90, TM-U230, TM-U220**

[Description] Transmits specified status in real-time as follows.

<b>m</b>	<b>Function</b>	<b>Related command</b>
1	Transmits basic ASB status.	<b>GS a</b>
5	Transmits battery status.	None

- [Notes]
- This is a real-time command that the printer executes upon receiving it. Take the following into consideration:
    - If this command interrupts the code string of another command, this command is processed as a parameter of the other command; therefore, the print result will not be correct.
    - If a command such as graphic or defined data has a code string that is the same as a code string in a parameter, the printer processes this command and then continues with the bit-image or other command.
  - The status or response format is the same as the format of the related command in the table above. See the description of the related command corresponding to **m**.
  - Basic ASB status transmission has the following rules.
    - This function makes the printer transmit the specified ASB to the host PC regardless of whether the setting for ASB is enabled or disabled.
    - This function doesn't affect the setting of whether ASB is enabled or disabled.
  - Battery status differs depending on printer model.

- The construction of battery status depends on printer model.
- This command is effective when the printer is disabled by **ESC =** (select peripheral device).
- With a serial interface, the printer executes this command when it is in offline, or in receive buffer-full status.
- When you use this command, obey the following rules.
  - After the host PC transmits the function data, the printer will send response data or status data back to the PC. Do not transmit more data from the PC until the response data or status data are received from the printer.
  - When operating with a serial interface, be sure to configure operation so that the host computer uses the printer only when it is READY.
  - When operating with a parallel interface, the data sent by this function (starting with Header and ending with NUL), as with other data, is first stored in the send buffer, then output in sequential order when the host computer changes to the reverse mode. Note that the send buffer capacity is 99 bytes, and any data exceeding this volume limit will be lost; therefore, when using this command, it is important to configure the operation so that the host computer's change to the reverse mode and the subsequent status send/receive process is performed quickly.
- With a parallel interface, if the printer is in BUSY condition, this command cannot be used in the following status conditions.
  - When DIP switch or memory switch (BUSY condition) is on: receive buffer-full.
  - When DIP switch or memory switch (BUSY condition) is off: offline, receive buffer-full, or error status.

[Model-dependent variations]

## TM-P60

### Program Example for all printers

```
PRINT #1, CHR$( &H10 );CHR$( &H14 );CHR$( 7 );CHR$( 1 )
```



## TM-P60

The setting of Memory switch [Msw8-1] doesn't affect the result of this command.

The battery status is a status that is automatically transmitted. The status is transmitted in the following cases.

- The printer is booted by turning the power on, or resetting printer. (When Memory switch [Msw8-1] is ON)
- The "Power source" in the status is changed.
- The "Battery remaining amount" in the status is changed.
- The printer processes this command.

The transmitted battery status from this printer is constructed by [Header ~ NUL] as shown in the following table.

Transmitted data	Hex	Decimal	Amount of data
Header	37H	55	1 byte
Identifier	45H	69	1 byte
Power source (*1)	30H or 31H	48 or 49	1 byte
Battery remaining amount (*2)	30H ~ 34H	48 ~ 52	1 byte
NUL	00H	0	1 byte

(\*1) "Power source" is as indicated in the following table.

Power source		Information
Hex	Decimal	
30H	48	Power provided from AC adapter
31H	49	Power provided from battery

(\*2) "Battery remaining amount" is as indicated in the following table.

Battery remaining amount		Information
Hex	Decimal	
30H	48	Battery remaining amount: H level
31H	49	Battery remaining amount: M level
32H	50	Battery remaining amount: L level
33H	51	Battery remaining amount: S level
34H	52	Battery isn't installed

- When the battery remaining amount is "L level," we recommend replacing or charging the battery.
- When the battery remaining amount is "S level," the printer terminates printing and goes offline.

You can confirm the battery remaining amount by looking at the "battery LED" (BAT).

When memory switch [Msw 8-2] is On, this printer beeps when it enters the "L level" or "S level."

When the printer power is on:

Battery	AC adapter	Battery LED (BAT.) status
Installed	Not installed	OFF: Battery remaining amount: H level
		Blinking: Battery remaining amount: M level
		ON: Battery remaining amount: L level or S (*1)
	Installed	Always Off
Not installed	Installed	Always Off

(\*1) When battery remaining amount is S level, the ERROR LED is On.

# CONFIDENTIAL

When the printer power is off:

<b>Battery</b>	<b>AC adapter</b>	<b>Battery LED (BAT.) status</b>
<b>Installed</b>	<b>Not installed</b>	<b>Always off</b>
	<b>Installed</b>	<b>Off: Battery is fully charged</b>
		<b>Blinking: Battery is being charged</b>
<b>Not installed</b>	<b>Installed</b>	<b>Always Off</b>

## DLE DC4 (*fn* = 8)

[Name] Clear buffer (s)

[Format] ASCII DLE DC4 **fn d1...d7**  
 Hex 10 14 **08 d1...d7**  
 Decimal 16 20 **8 d1...d7**

[Printers not featuring this command] **TM-U230, TM-U220**

[Range] **fn = 8**  
**d1 = 1, d2 = 3, d3 = 20, d4 = 1, d5 = 6, d6 = 2, d7 = 8**

[Description] Clears all data stored in the receive buffer and the print buffer and transmits Clear response.

- [Notes]
- Do not use this command in a system in which the printer is used with the OPOS driver and Java POS driver that are provided by Seiko Epson Corporation.
  - If a code string of this command is embedded within parameters of other commands (graphics data, defined data), the printer performs a buffer clear. If the printer has this command, be sure to check if the code string of this command is embedded within the parameters of another command before transmitting the bit-image data and defined data.
  - This command is ignored in the following state:
    - During transmission of block data (Header ~ NUL)
  - This command is effective when the printer is disabled by **ESC =** (select peripheral device).
  - If this command is sent while another command is processing, processing of the other command is canceled.
  - If this command is processed in page mode, the printer returns to standard mode. The setting of **ESC W** is changed to the default value.
  - This command does not change or initialize settings of other commands (except for **ESC W** with page mode selected).
  - Executing this command moves the print position to the beginning of a line.
  - If this command is executed when a recoverable error has occurred, the printer recovers from the error. This is the same function as the **DLE ENQ2** command.

- With a serial interface, the printer executes this command even when it is in offline, receive buffer full, or error status.
- With a parallel interface, if the printer is BUSY, this command cannot be used in the following states.
  - When DIP switch (BUSY condition) is on: receive buffer full
  - When DIP switch (BUSY condition) is off: offline, receive buffer full, or error status
- When buffer clear processing is finished, the printer transmits the clear response as shown below to the host.

Clear response	Hex	Decimal	Data
Header	37H	55	1 byte
Identifier	25H	37	1 byte
NUL	00H	0	1 byte

- When you use this command, obey the following rules.
  - When host PC transmits the function data, transmit the next data after receiving the corresponding data (header ~ NULL) from the printer.
  - When operating with a serial interface, be sure to configure operation so that the host computer uses the printer only when it is READY.
  - When operating with a parallel interface, the data sent by this function (starting with Header and ending with NUL), as with other data, is first stored in the send buffer, then output in sequential order when the host computer changes to the reverse mode. Note that the send buffer capacity is 99 bytes, and any data exceeding this volume limit will be lost; therefore, when using this command, it is important to configure the operation so that the host computer's change to the reverse mode and the subsequent status send /receive process is performed quickly.
- When communication with the printer uses XON/XOFF control with serial interface, the XOFF code may interrupt the "Header to NUL" data string.

- The clear response can be differentiated from other transmission data according to specific data of the transmission data block. When the header transmitted from the printer is [Hex=37H/Decimal=55], treat NUL [hex = 00H/decimal =0] as a data group and identify it according to the combination of the header and the identifier.

[Model-dependent variations]

**TM-J2000/J2100, TM-T90, TM-T88IV, TM-T70, TM-L90, TM-P60**

## Program Example

```
PRINT #1, CHR$( &H10 );CHR$( &H14 );CHR$( 8 );CHR$( 1 );CHR$( 3 );CHR$( 20 );CHR$( 1 );CHR$( 6 );CHR$( 2 );CHR$( 8 );
```

### TM-J2000/J2100

The **BUSY** condition is selected by memory switch 1-3.

When using the following commands, be sure there is no sequence that corresponds to the sequence of this command in the data line.

Graphics: **GS ( L**

Bit image: **ESC \*, FS q, GS \*, GS Q 0, GS v 0**

Character pattern: **ESC &, FS 2**

### TM-T90, TM-L90

The **BUSY** condition is selected by memory switch 1-3.

When using the following commands, be sure there is no sequence that corresponds to the sequence of this command in the data line.

Graphics: **GS ( L**

Bit image: **ESC \*, FS q, GS \*, GS v 0**

Character pattern: **ESC &, FS 2**

### TM-T88IV

The **BUSY** condition is selected by memory switch 2-1.

When using the following commands, be sure there is no sequence that corresponds to the sequence of this command in the data line.

# C O N F I D E N T I A L

**Graphics: GS ( L**

**Bit image: ESC \*, FS q, GS \*, GS v 0**

**Character pattern: ESC &, FS 2**

## **TM-T70**

The BUSY condition is selected by memory switch 2-1.

When using the following commands, be sure there is no sequence that corresponds to the sequence of this command in the data line.

**Graphics: GS ( L**

**Bit image: ESC \*, GS \***

**Character pattern: ESC &, FS 2**

## **TM-P60**

When using the graphic command **GS ( L**, be sure there is no sequence that corresponds to the sequence of this command in the data line.

## ESC ( A

[Name] Control beeper tones

[Printers not featuring this command] **TM-J2000/J2100, TM-T90, TM-T88IV, TM-T70, TM-L90, TM-U220**

[Description] Performs the various tasks related to the control of the beeper (listed in the table below).

- Function code (**fn**) specifies the function.

<b>fn</b>	<b>Function No.</b>	<b>Function name</b>
48	<b>Function 48</b>	Beeps integrated beeper
97	<b>Function 97</b>	Beep integrated beeper in <b>TM-U230</b> models.
98	<b>Function 98</b>	Set integrated beeper when offline factors occur in <b>TM-U230</b> models.
99	<b>Function 99</b>	Set integrated beeper except when offline factors occur in <b>TM-U230</b> models.

- **pL, pH** specifies (**pL + pH × 256**) as the number of bytes after **pH** (**fn** and **[parameters]**). Description of the **[parameters]** is described in each function.

### [Notes]

- The functions of this command are determined by the (**fn**) setting. Actual command operation varies according to function.

#### Program Example 1

```
PRINT #1, CHR$( &H1B ); " (A"; CHR$( 4 ); CHR$( 0 ); CHR$( 48 ); CHR$( 49 ); CHR$( 3 ); CHR$( 15 ); ←<Function 48>
```

[Model-dependent variations] **TM-P60, TM-U230**

### TM-P60

**The printer supports function 48.**



## **TM-U230**

The printer supports functions 97 to 99.

When controlling the integrated beeper with this command, set DIP switch [SW2-8] off. Turn off the printer before changing DIP switch settings.

The integrated beeper corresponds to the PAPER OUT LED in hardware configuration. Therefore when integrated beeper sounds, the PAPER OUT LED blinks. When integrated beeper stops beeping, PAPER OUT LED goes off. When there is no paper and this command is executed to stop beeping, the PAPER OUT LED is off.

The printer is not operated by this command under the following conditions:

- PAPER OUT LED blinks due to waiting for online recovery when changing the paper.
- PAPER OUT LED blinks due to waiting for switch during self-test printing.

## ESC ( A *pL pH fn n c t* <Function 48 >

[Format]	ASCII	ESC (	A	<b>pL</b>	<b>pH</b>	<b>fn</b>	<b>n</b>	<b>c</b>	<b>t</b>
	Hex	1B 28	41	<b>04</b>	<b>00</b>	<b>30</b>	<b>n</b>	<b>c</b>	<b>t</b>
	Decimal	27 40	65	<b>4</b>	<b>0</b>	<b>48</b>	<b>n</b>	<b>c</b>	<b>t</b>

[Range]  $(pL + pH \times 256) = 4$  ( $pL = 4, pH = 0$ )  
**fn** = 48  
**TM-P60:**  $48 \leq n \leq 58$   
 $1 \leq c \leq 63$   
 $10 \leq t \leq 255$

[Description] Beeps the integrated beeper.

- n** specifies the tone that is beeped. The tones depend on the printer model. When **n** specifies "doesn't beep," the parameters **c** and **t** are still required for this function.
- c** specifies the number of beeps.
- t** specifies the beeping cycle time ( $t \times 100$  ms).

[Notes] ■ This function beeps the beeper " $(t \times 100$  ms)  $\times$  **c**."  
 Example: When tone (**n**) specifies "500ms beeps" and **c** = 3 and **t** = 10

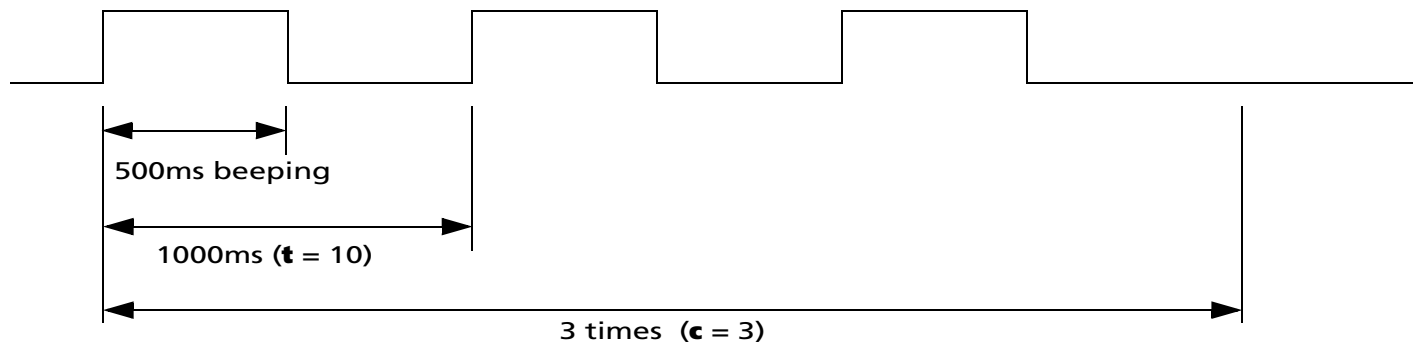

- If this command is newly processed during beeping of the buzzer, the current process for beeping the buzzer is stopped and the new process for beeping the buzzer is started.
- Integrated beeper beeping by this function stops due to any of the following factors.
  - Finish specification of (c).
  - The parameter **n** specifies “doesn’t beep” by this function.
  - Printer processes **DLE DC4 (fn = 2)** command.
  - Reset or power off.

**[Model-dependent variations]    TM-P60, TM-U230**

## TM-P60

The setting of [Msw 8-2] ~ [Msw 8-5] doesn’t affect the performance of this command.

The “doesn’t beep” (**n = 48**) affects beeping caused by this function only. It doesn’t affect warning beeping (Example: roll paper end, and during status sheet printing.)

The following beeping tones and timing can be specified by **n**.

<b>n</b>	<b>Tone</b>
<b>48</b>	<b>doesn’t beep</b>
<b>49</b>	<b>1280Hz: 1000ms beeping</b>
<b>50</b>	<b>4100Hz: 1000ms beeping</b>
<b>51</b>	<b>1280Hz: 200ms beeping</b>
<b>52</b>	<b>4100Hz: 200ms beeping</b>
<b>53</b>	<b>1280Hz: 200ms beeping -&gt; 200ms off -&gt; 200ms beeping</b>
<b>54</b>	<b>4100Hz: 200ms beeping -&gt; 200ms off -&gt; 200ms beeping</b>
<b>55</b>	<b>1280Hz: 500ms beeping</b>

# CONFIDENTIAL

<b>n</b>	<b>Tone</b>
<b>56</b>	<b>4100Hz: 500ms beeping</b>
<b>57</b>	<b>1280Hz: 200ms beeping -&gt; 200ms off -&gt; 200ms beeping -&gt; 200ms off -&gt; 200ms beeping</b>
<b>58</b>	<b>4100Hz: 200ms beeping -&gt; 200ms off -&gt; 200ms beeping -&gt; 200ms off -&gt; 200ms beeping</b>

## **TM-U230**

The printer does not support this function.

## ESC ( A *pl* *ph* *fn* *n* *c* *t1* *t2* <Function 97 > (TM-U230)

---

[Name]	Beep integrated beeper in <b>TM-U230</b> models										
[Format]	ASCII	ESC (	A	<b>pl</b>	<b>ph</b>	<b>fn</b>	<b>n</b>	<b>c</b>	<b>t1</b>	<b>t2</b>	
	Hex	1B	28	41	<b>05</b>	<b>00</b>	<b>61</b>	<b>n</b>	<b>c</b>	<b>t1</b>	<b>t2</b>
	Decimal	27	40	65	<b>5</b>	<b>0</b>	<b>97</b>	<b>n</b>	<b>c</b>	<b>t1</b>	<b>t2</b>
[Range]	$(pl + ph \times 256) = 5$ ( <b>pl</b> = 5, <b>ph</b> = 0) <b>fn</b> = 97 <b>n</b> = 100 $0 \leq c \leq 63$ $0 \leq t1 \leq 255$ $0 \leq t2 \leq 255$										
[Description]	Beeps the integrated beeper. <ul style="list-style-type: none"> <li>• <b>c</b> specifies times of beeping.</li> <li>• <b>t1</b> specifies beeping time (<b>t1</b> × 100 ms).</li> <li>• <b>t2</b> specifies time for stop beeping (<b>t2</b> × 100 ms).</li> </ul>										
[Notes]	<ul style="list-style-type: none"> <li>■ This function repeats integrated beeper control of [(<b>t1</b> × 100 ms) beep/ (<b>t2</b> × 100 ms) stop] <b>c</b> times.</li> <li>■ If this command is newly processed during beeping of the buzzer, the current process for beeping the buzzer is stopped and the new process for beeping the buzzer is started.</li> <li>■ Integrated beeper beeping by this function stops due to any of the following factors.             <ul style="list-style-type: none"> <li>• Finish specification of (<b>c</b>).</li> <li>• Offline factor specified by Function 98 has occurred.</li> <li>• Factors specified by Function 99 have occurred.</li> <li>• Reset or power off.</li> </ul> </li> </ul>										

## ESC ( A *pL pH fn a b n c t1 t2* <Function 98 > (TM-U230)

---

[Name] Set integrated beeper when offline factors occur in **TM-U230** models

[Format]

ASCII	ESC (	A	<b>pL</b>	<b>pH</b>	<b>fn</b>	<b>a</b>	<b>b</b>	<b>n</b>	<b>c</b>	<b>t1</b>	<b>t2</b>
Hex	1B 28 41	<b>07</b>	<b>00</b>	<b>62</b>	<b>a</b>	<b>b</b>	<b>n</b>	<b>c</b>	<b>t1</b>	<b>t2</b>	
Decimal	27 40 65	<b>7</b>	<b>0</b>	<b>98</b>	<b>a</b>	<b>b</b>	<b>n</b>	<b>c</b>	<b>t1</b>	<b>t2</b>	

[Range]

$(pL + pH \times 256) = 7$  ( $pL = 7, pH = 0$ )  
**fn** = 98  
 $48 \leq a \leq 51$   
**b** = 1  
**n** = 100  
**c** = 0, 255  
 $1 \leq t1 \leq 50, t1 = 255$   
 $1 \leq t2 \leq 50$

[Default] No paper printing stops (**a** = 49): Beeps the integrated beeper (select sound variation by DIP switch [SW2-5]).  
 Except above (**a** = 48, 50, 51): Does not beep the integrated beeper.

[Description] Set the integrated beeper control when specified offline is occurred.

- **a** specifies the offline factor.

<b>a</b>	<b>Offline factor</b>
48	Cover open.
49	Printing stop when there is no paper.
50	Recoverable error occur.
51	Unrecoverable error occur.

- **c** specifies the beeps integrated beeper/ not beeps integrated beeper when specified offline is occurred.

<b>c</b>	<b>Beeping method</b>
0	Beeps integrated beeper
255	Does not beep the integrated beeper

- $1 \leq \mathbf{t1} \leq 50$  specify beeping time ( $\mathbf{t1} \times 100$  ms).  
 $\mathbf{t1} = 255$  specify beeping time (infinity).
- $\mathbf{t2}$  specify time for stop beeping ( $\mathbf{t2} \times 100$  ms).

[Notes]

- This function repeats integrated beeper control of [ $(\mathbf{t1} \times 100$  ms) beep/  $(\mathbf{t2} \times 100$  ms) stop] when offline factors have occurred. However, ( $\mathbf{t1} = 255$ ) causes continuous beeping.
- When the printer is offline, the integrated beeper will stops under any of the following conditions:
  - The offline factor is cleared.
  - The FEED switch is pressed.
  - Reset or power off.
- Setting of this function is enabled until reset or power off.

## ESC ( A *pl* *ph* *fn* *a* *b* *n* *c* *t1* *t2* <Function 99 > (TM-U230)

[Name] Set integrated beeper except when offline factors occur in **TM-U230** models

[Format] ASCII ESC ( A **pl** **ph** **fn** **a** **b** **n** **c** **t1** **t2**  
 Hex 1B 28 41 **07** **00** **63** **a** **b** **n** **c** **t1** **t2**  
 Decimal 27 40 65 **7** **0** **99** **a** **b** **n** **c** **t1** **t2**

[Range] (**pl** + **ph** × 256) = 7 (**pl** = 7, **ph** = 0)  
**fn** = 99  
**a** = 48  
**b** = 1  
**n** = 100  
**c** = 0, 255  
 1 ≤ **t1** ≤ 50, **t1** = 255  
 1 ≤ **t2** ≤ 50

[Default] Beeps the integrated beeper (select sound variation by DIP switch [SW2-5]).

[Description] Sets the integrated beeper control when roll paper near end detector detects [No roll paper].

<b>a</b>	Offline factor
48	Roll paper near end detector: no roll paper

- **c** specifies whether the integrated beeper beeps when the roll paper near end detector detects a paper-end.

<b>c</b>	Beep method
0	Does not beep the integrated beeper
255	Beeps integrated beeper

- 1 ≤ **t1** ≤ 50 specifies beeping time (**t1** × 100ms).  
**t1** = 255 specifies beeping time (infinity).
- **t2** specifies time for stop beeping (**t2** × 100ms).



[Notes]

- This function repeats integrated beeper control of [(**t1** × 100 ms) beep/ (**t2** × 100 ms) stop] when the roll paper near end detector detects a paper-end. However, when (**t1** = 255) continuous beeping occurs.
- If roll paper detector is selected to stop printing when there is no paper, when the detector detects no roll paper and goes offline, the setting of this function is disabled.
- When there is no roll paper, the integrated beeper can be stopped by any of the following:
  - Clear the factor.
  - Press FEED switch.
  - Offline factor specified by Function 98 occurs.
  - Process the [integrated beeper stop (**c** = 0)] in this function.
  - Reset or turn off power.
- Setting of this function is enabled until reset or power off.

## ESC =

[Name] Select peripheral device

[Format] ASCII ESC = **n**  
 Hex 1B 3D **n**  
 Decimal 27 61 **n**

[Range]  $1 \leq n \leq 3$

[Default] **TM-J2000/J2100:** Serial interface model:  
**n = 1** When [memory switch [DM-D (customer display) connection] is OFF.  
**n = 2** When [memory switch [DM-D (customer display) connection] is ON.  
 Parallel interface model:  
**n = 1**  
**TM-T90, TM-T88IV, TM-T70, TM-L90, TM-P60, TM-U230, TM-U220: n = 1**

[Printers not featuring this command] None

[Default] Selects the device to which the host computer transmits data, using **n** as follows:

<b>n</b>	<b>Function</b>
1,3	Enables printer.
2	Disables printer.

- [Notes]
- When the printer is disabled, it ignores all received data and commands with the exception of **ESC =** and real-time commands.
  - If ASB is enabled when the printer is disabled by this command, the printer transmits the ASB status message whenever the status changes. See the description of **GS a** for ASB function.
  - Settings of this command are effective until **ESC @** is executed, the printer is reset, or the power is turned off.
  - The default value when the power supply is turned on and when **ESC @** is executed might be different.
    - The default value when the power supply is turned on becomes the [default value].

- The selection of peripherals after **ESC @** is executed is shown in the next table.

		<b>n</b>		
Setting when power supply is turned on	When the switch of the [DM-D (customer display) connection] is turned off	1		
	When the switch of the [DM-D (customer display) connection] is turned on	2		
Setting immediately before execution of <b>ESC @</b> (*1)		1	2	3
Setting after <b>ESC @</b> is executed	When the switch of the [DM-D (customer display) connection] is turned off	1	2	1
	When the switch of the [DM-D (customer display) connection] is turned on	1	2	2

- (\*1) When the setting of ESC = is (**n** = 2), **n** is not changed because **ESC @** is not executed.
- In the model not equipped with the switch of the parallel interface specification and the connection of DM-D (customer display), the settings are the same as when the switch in the above table is off.

[Model-dependent variations]

**TM-J2000/J2100, TM-T90, TM-T88IV, TM-T70, TM-L90, TM-P60, TM-U230, TM-U220**

### Program Example for all printers

```
PRINT #1, CHR$(&H1B); "=";CHR$(1); ← Printer enabled
PRINT #1, "AAAAA";
PRINT #1, CHR$(&H1B); "=";CHR$(2); ← Printer disabled
PRINT #1, "BBBBB";
PRINT #1, CHR$(&H1B); "=";CHR$(3); ← Pinter enabled
PRINT #1, " CCCCC"; CHR$(&HA);
```

### Print Sample

AAAAA CCCCC

### TM-J2000/J2100

The memory switch which selects the connection of DM-D (customer display) is Msw 1-6.

### TM-T90, TM-T88IV, TM-T70, TM-L90, TM-P60, TM-U230, TM-U220

There is no memory switch to select the connection of a DM-D (customer display).

## ESC @

[Name]	Initialize printer						
[Format]	<table border="0"> <tr> <td>ASCII</td> <td>ESC @</td> </tr> <tr> <td>Hex</td> <td>1B 40</td> </tr> <tr> <td>Decimal</td> <td>27 64</td> </tr> </table>	ASCII	ESC @	Hex	1B 40	Decimal	27 64
ASCII	ESC @						
Hex	1B 40						
Decimal	27 64						
[Range]	None						
[Default]	None						
[Printers not featuring this command]	None						
[Description]	<p>Clears the data in the print buffer and resets the printer modes to the modes that were in effect when the power was turned on.</p> <ul style="list-style-type: none"> <li>• Any macro definitions are not cleared.</li> <li>• Offline response selection is not cleared.</li> <li>• Contents of user NV memory are not cleared.</li> <li>• NV graphics (NV bit image) and NV user memory are not cleared.</li> <li>• The maintenance counter value is not affected by this command.</li> <li>• The specifying of offline response isn't cleared.</li> </ul>						
[Notes]	<ul style="list-style-type: none"> <li>■ The DIP switch settings are not checked again.</li> <li>■ The data in the receive buffer is not cleared.</li> <li>■ When this command is processed in page mode, the printer deletes the data in the print areas, initializes all settings, and selects standard mode.</li> <li>■ This command can cancel all the settings, such as print mode and line feed, at the same time.</li> <li>■ The print position moves to the beginning of the line when this command is executed. When a left margin is set in standard mode, the position of the left margin is the beginning of the line or there is no data in the print buffer.</li> </ul>						

- A set value of **ESC =** after this command is executed is shown in the following table.

Setting of <b>ESC =</b> immediately before execution of <b>ESC @</b>		1	2	3
Setting after <b>ESC @</b> is executed	When the switch of the DM-D (customer display) connection is OFF.	1	-	1
	When the switch of the DM-D (customer display) connection is ON.	1	-	2

- When the setting of **ESC =** is (**n = 2**), **n** is not changed because **ESC @** is not executed.
- For the model not equipped with the switch of the parallel interface specification and the DM-D (customer display) connection, the settings are the same as when the switch is OFF in the above table.

[Model-dependent variations]

**TM-J2000/J2100, TM-T90, TM-T88IV, TM-T70, TM-L90, TM-P60, TM-U230, TM-U220**

### Program Example for all printers

```
PRINT #1, CHR$(&H1D); "P";CHR$(180);CHR$(180);
PRINT #1, CHR$(&H1B); "3";CHR$(60);
PRINT #1, CHR$(&H1B); "U";CHR$(1);
PRINT #1, CHR$(&H1B); "E";CHR$(1);
PRINT #1, CHR$(&H1B); "-";CHR$(1);
PRINT #1, CHR$(&H1D); "!";CHR$(17);
PRINT #1, "AAAAA"; CHR$(&HA);
PRINT #1, CHR$(&H1B);"@"; ← Initialize printer
PRINT #1, "BBBBB"; CHR$(&HA);
```

### Print Sample

```
AAAAA
BBBBB ←All settings are canceled after ESC @ is executed
```

### TM-J2000/J2100

The memory switch which selects the connection of DM-D (customer display) is Msw 1-6.

### TM-T90, TM-T88IV, TM-T70, TM-L90, TM-P60, TM-U230, TM-U220

These printers do not have the switch that selects "the connection of DM-D (customer display)."

## ESC L

[Name] Select page mode

[Format] ASCII ESC L  
Hex 1B 4C  
Decimal 27 76

[Range] None

[Default] None

[Printers not featuring this command] **TM-U230**, **TM-U220**

[Description] Switches from standard mode to page mode.

- [Notes]
- This command is enabled only when processed at the beginning of the line in standard mode. In other cases, this command is ignored.
  - The print position is the starting position specified by **ESC T** within the print area defined by **ESC W**.
  - The following commands switch the settings for page mode because these commands can be set independently in standard mode and in page mode:
    - **ESC SP**, **ESC 2**, **ESC 3**, **ESC U**, and **FS S**
  - The following commands are disabled in page mode.
    - **ESC L**, **FS g 1**, **FS q**, **GS ( A**, **GS ( C** (part of functions), **GS ( E**, **GS ( L / GS 8 L** (part of functions), **GS ( M** (part of functions), **GS (P**, **GS T**, and **GS g 0**
  - The following commands are not effective in page mode. If these commands are processed in page mode, an internal flag is activated, and this flag is enabled when the printer returns to standard mode.
    - **ESC V**, **ESC a**, **ESC {**, **GS L**, and **GS W**
  - The printer returns to standard mode with **ESC S**, **FF**, and **ESC @**. When it returns to standard mode by **ESC @**, all settings are canceled.
  - Standard mode is selected as the default.
  - In page mode, the printer prints the data in the print buffer for the print area specified by **ESC W** collectively by **FF** or **ESC FF**. When executing the print and paper feed commands, such as **LF**, **CR**, **ESC J**, and **ESC d**, only the print position moves; the printer does not perform actual printing.

# C O N F I D E N T I A L

[Model-dependent variations]

**TM-J2000/J2100**

See program example and print sample for ESC L, FS L, and ESC S.

**TM-J2000/J2100**

**ESC r is disabled in page mode with this printer. This is an addition to the standard specification.**

## ESC S

[Name] Select standard mode

[Format] ASCII ESC S  
Hex 1B 53  
Decimal 27 83

[Range] None

[Default] None

[Printers not featuring this command] **TM-U230**, **TM-U220**

[Description] Switches from page mode to standard mode.

- [Notes]
- This command is enabled only in page mode. Page mode can be selected by **ESC L**.
  - When this command is executed, data in all the print areas is cleared, the print area set by **ESC W** returns to the default value, but the value set by **ESC T** is maintained.
  - The following commands switch the settings for standard mode because these commands can be set independently in standard mode and in page mode:
    - **ESC SP**, **ESC 2**, **ESC 3**, **ESC U**, and **FS S**.
  - In standard mode, **CAN**, **ESC FF**, **GS \$**, **GS O** and **GS \** are ignored.
  - The settings of **ESC T** and **ESC W**, **GS ( P** do not affect printing in standard mode.
  - The printer selects page mode with **ESC L**.
  - Standard mode is selected as the default.

[Model-dependent variations] None



# CONFIDENTIAL

## Program Example for ESC L and ESC S

### Program Example for all printers

```
PRINT #1, CHR$(&H1B);"L"; ←Select page mode
PRINT #1, CHR$(&H1D);"P";CHR$(180);CHR$(180);
PRINT #1, CHR$(&H1B);"W";CHR$(0);CHR$(0);CHR$(0);
CHR$(0);CHR$(240);CHR$(0);CHR$(200);CHR$(0);
PRINT #1, CHR$(&H1B);"T";CHR$(0); ←Select print direction
PRINT #1, "AAAAA"; CHR$(&HA);
PRINT #1, "BBBBB"; CHR$(&HA);
PRINT #1, "CCCCC";
PRINT #1, CHR$(&H1B);CHR$(&HC); ←Batch print
PRINT #1, CHR$(&H1B);"S"; ←Select standard mode
```

### Print Sample

```
AAAAA
BBBBB
CCCCC
```

## ESC p

[Name]	Generate pulse					
[Format]	ASCII	ESC	p	<b>m</b>	<b>t1</b>	<b>t2</b>
	Hex	1B	70	<b>m</b>	<b>t1</b>	<b>t2</b>
	Decimal	27	112	<b>m</b>	<b>t1</b>	<b>t2</b>
[Range]	<b>m</b> = 0, 1, 48, 49					
	0 ≤ <b>t1</b> ≤ 255					
	0 ≤ <b>t2</b> ≤ 255					
[Default]	None					

[Printers not featuring this command] **TM-P60**

[Description] Outputs the pulse specified by **t1** and **t2** to the specified connector pin **m** as follows:

<b>m</b>	Connector pin
0, 48	Drawer kick-out connector pin 2
1, 49	Drawer kick-out connector pin 5

- The pulse for ON time is (**t1** × 2 msec) and for OFF time is (**t2** × 2 msec).

[Notes] ■ If **t2** < **t1**, the OFF time is equal to the ON time.

[Model-dependent variations] **TM-T88IV**, **TM-T70**, **TM-U230**, **TM-U220**

### Program Example for all printers

```
PRINT #1, CHR$( &H1B ); "p";CHR$( 0 );CHR$( 25 );CHR$( 250 );
```

### **TM-T88IV**, **TM-T70**

With specifications that have a buzzer, a pulse signal sounds the buzzer with this command. Buzzer control and drawer control is set with the buzzer circuit board DIP switches. Turn off the printer before changing DIP switch settings.

# CONFIDENTIAL

When used together with the UB series with the buzzer function, the buzzer function of the UB series does not operate.

Switch number	Setting	Function
1	OFF	Not use drawer kick connector pin no. 2 for sounding the buzzer
	ON	Use drawer kick connector pin no. 2 for sounding the buzzer
2	OFF	Not use drawer kick connector pin no. 5 for sounding the buzzer
	ON	Use drawer kick connector pin no. 5 for sounding the buzzer

## TM-U230

If  $t1 < 50$ ,  $t1$  is supposed to be 50.

If  $t2 < 50$ ,  $t2$  is supposed to be 50.

## TM-U220

If  $t2 < 50$ ,  $t2$  is supposed to be 50.

## GS ( A

[Name]	Execute test print							
[Format]	ASCII	GS	(	A	<b>pL</b>	<b>pH</b>	<b>n</b>	<b>m</b>
	Hex	1D	28	41	<b>02</b>	<b>00</b>	<b>n</b>	<b>m</b>
	Decimal	29	40	65	<b>2</b>	<b>0</b>	<b>n</b>	<b>m</b>

[Printers not featuring this command] **TM-P60**

[Range]  $(pL + (pH \times 256)) = 2$  ( $pL = 2, pH = 0$ )  
 $0 \leq n \leq 2, 48 \leq n \leq 50, 1 \leq m \leq 3, 49 \leq m \leq 51$   
**TM-J2000/J2100, TM-T90, TM-T88IV, TM-T70, TM-U230, TM-U220:  $1 \leq m \leq 3, 49 \leq m \leq 51$**   
**TM-L90:  $0 \leq m \leq 3, 49 \leq m \leq 50, m = 64$**

[Description] Executes a specified test print.

- **pL, pH** specifies ( $pL + pH \times 256$ ) as the number of bytes after **pH** (**n** and **m**).
- **n** specifies the paper used for the test print as follows:

<b>n</b>	<b>Paper</b>
0, 48	Basic sheet (roll paper)
1, 49 2, 50	Roll paper

- **m** specifies a test pattern as follows:

<b>m</b>	<b>Test pattern</b>
1, 49	Hexadecimal dump
2, 50	Printer status printing
3, 51	Rolling pattern
64	Automatic setting of paper layout

- [Notes]
- This command is effective only when processed at the beginning of the line in standard mode.
  - If this command is processed while a macro is being defined, the printer cancels macro definition and starts processing this command. At that time, the macro becomes undefined.
  - After processing this command, the printer performs a software reset. Executing this command puts the printer in the same status as when the power is turned on. Transmit commands or data after confirming the complete software reset.
  - If hexadecimal dump (**m** = 1, 49) is specified, the printer prints a message. Transmit commands or data after the printing.
  - When processing printer status printing (**m** = 2, 50), rolling pattern printing (**m** = 3, 51), and automatic setting of paper layout (**m** = 64), there are the restrictions described below.
    - The printer does not process real-time commands.
    - Even if "ASB is enabled" is specified, the printer does not send ASB status.
  - When processing the automatic setting (**m** = 64) of the paper layout, the printer feeds the current roll paper to measure the paper layout. During this time, the printer does not print. After the measuring, it writes the setting of layout from the measuring to the non-volatile memory. Please note the following points when you use this function.
    - Do not turn off the power or reset the printer from the interface when this command is being executed.
    - The printer may be BUSY when storing data and will not receive any data. In this case, be sure not to transmit data from the host.
    - Excessive use of this function may destroy the non-volatile memory. As a guideline, do not use any combination of the following commands more than 10 times per day for writing data to the non-volatile memory: **GS ( A** (part of functions), **GS ( C** (part of functions), **GS ( E** (part of functions), **GS ( L** (part of functions), **GS ( M** (part of functions), **GS g 0**, **FS g 1**, **FS q**.
  - When automatic setting (**m** = 64) of the paper layout is executed, paper layout which is set by Function 49 of **GS ( E** is changed. See Function 49 of **GS ( E** for details of paper layout. Paper layout set is valid until the following operations are executed. They are not initialized by power off or ESC @.
    - Execution of Function 48 or 49.
    - Execution of automatic setting mode of paper layout by panel operation when the power is turned on.

- For the label paper or black paper control, it calculates the effect value used for the actual print operation based on the paper layout set value, the paper width set value, or the limitation value of the mechanical structure (mechanical pitch or position of the print head, and so on). The set value and effect value can be acquired by Function 50 of **GS ( E**.

[Model-dependent variations]

## TM-L90

### Program Example

```
PRINT #1, CHR$( &H1D ); " (A" ; CHR$( 1 ); CHR$( 2 );
```

## TM-L90

When processing for automatic setting of paper layout (**m = 64**), the printer recognizes origin of layout on current paper as the setting value, and other setting values are read from measuring or fixed values. After executing this command, the setting values of paper layout can be confirmed by **GS ( E <Function 50>**.

- The letters in parentheses ( ) indicate the parameter of **GS ( E <Function 49>**.

When origin of layout (**sa**) is "None (paper layout is not used)":

Parameter of Paper layout	Setting value
The layout of the vertical direction ( <b>sb</b> ) ~ ( <b>sf</b> )	None
The layout of the horizontal direction ( <b>sg</b> ), ( <b>sh</b> )	None

When origin of layout (**sa**) is "Top of a black mark" (**BM = black mark**):

Parameter of Paper layout	Setting value
Top of a BM ~ top of next BM ( <b>sb</b> )	Measured value
Top of a BM ~ bottom of BM ( <b>sc</b> )	Measured value
Other than the layout of the vertical direction ( <b>sd</b> ) ~ ( <b>sf</b> )	Fixed value
The layout of the horizontal direction ( <b>sg</b> ), ( <b>sh</b> )	Fixed value

When origin of layout (sa) is "Bottom of a label":

Parameter of Paper layout	Setting value
Bottom of a label ~ bottom of the next label (sb)	Measured value
Bottom of a label ~ top of the next label (sc)	Measured value
Layout in the vertical direction (sd) ~ (sf)	Fixed value
The layout in the horizontal direction (sg), (sh)	Fixed value

If the installed paper is label paper with black mark in procedure 5, the printer may not recognize it correctly. In this case, the origin of layout is set to "none." **GS ( E <Function 49>** is recommended for label paper with black mark.

Recommended procedure of exchanging paper:

Procedure	Processing for host PC	Performing of the printer
1.	Transmit <b>GS ( E &lt;Function 1&gt;</b> to the printer.	Entering user setting mode.
2.	Operator's operation: exchange the paper.	—
3.	Transmit <b>GS ( E &lt;Function 49&gt;</b> to the printer.	Specifying the paper layout to "None (does not use paper layout)."
4.	Transmit <b>GS ( E &lt;Function 2&gt;</b> to the printer.	Executing software reset, and close user setting mode.
5.	Transmit <b>GS ( A (m = 64)</b> to the printer.	Executing automatic setting of paper layout.

**Note:** If you skip procedure 1, an error may occur.

Paper layout setting value can be changed in the automatic setting mode of paper layout by panel operation when the printer power is turned on. However, if paper to be used is a label (with a black mark), the automatic setting mode cannot be used. Paper layout needs to be set by Function 49 of **GS ( E**. Recovery from a paper layout error can be set by memory switches as below. See Function 3 of **GS ( E** of the model dependent variation for details.

**TM-L90 with Peeler:** [Msw8-1] and [Msw8-2]

**TM-L90 models without Peeler:** [Msw8-2]

## GS ( D

[Name] Enable/disable real-time command

[Format] ASCII GS ( D **pl pH m [a1 b1]...[ak bk]**  
 Hex 1D 28 44 **pl pH 14 [a1 b1]...[ak bk]**  
 Decimal 29 40 68 **pl pH 20 [a1 b1]...[ak bk]**

[Printers not featuring this command] **TM-U230**

[Range] (**pl + pH** × 256) = 3, 5 (**pl** = 3, 5, **pH** = 0)  
**m** = 20

**TM-J2000/J2100, TM-T90, TM-T88IV, TM-T70, TM-L90:**

**a** = 1, 2

**b** = 0, 1, 48, 49

**TM-P60:**

**a** = 2

**b** = 0, 1, 48, 49

**TM-U220:**

**a** = 1

**b** = 0, 1, 48, 49

[Default] **b** = 1 [(**a** = 1) **DLE DC4 fn m t** (**fn** = 1): enable]

**b** = 0 [(**a** = 2) **DLE DC4 fn m t** (**fn** = 2): disable]

[Description] Enables or disables the real-time command.

- **pl, pH** specifies (**pl + pH** × 256) as the number of bytes after **pH** (**m** and **[a1 b1]...[ak bk]**).
- **a** specifies the type of real-time command.
- **b** specifies enable/disable of real-time command processing.



<b>a</b>	<b>b</b>	<b>Function</b>
1	0, 48	Disable <b>DLE DC4 fn m t (fn = 1)</b> (does not execute the process)
	1, 49	Enable <b>DLE DC4 fn m t (fn = 1)</b> (executes the process)
2	0, 48	Disable <b>DLE DC4 fn m t (fn = 2)</b> (does not execute the process)
	1, 49	Enable <b>DLE DC4 fn m t (fn = 2)</b> (executes the process)

- **a** specifies the type of real-time command.
- **b** specifies enable/disable of real-time command processing.

<b>a</b>	<b>b</b>	<b>Real-time command type</b>
1	0, 48	Disable <b>DLE DC4 n m t (n = 1)</b> : (does not execute the process)
	1, 49	Enable <b>DLE DC4 n m t (n = 1)</b> : (execute the process)
2	0, 48	Disable <b>DLE DC4 n a b (n = 2)</b> : (does not execute the process)
	1, 49	Enable <b>DLE DC4 n a b (n = 2)</b> : (execute the process)

**DLE DC4 n m t (n=1)**: Generate pulse in real-time.

**DLE DC4 n a b (n=2)**: Execute power-off sequence.

[Notes]

- The printer processes each real-time command that is enabled (**b**=1, 49) upon receiving it.
- A real-time command specified as disabled (**b**=0, 48) is not processed.
- The setting of this command is effective until **ESC @** is executed, the printer is reset, or the power is turned off.

- If you transmit a command for graphics data or defined data that contains the sequence **DLE DC4**, be sure to disable real-time command (**b=0, 48**) processing before transmitting the graphics data or defined data command. Then the printer will process the sequence **DLE DC4** as image data.

## Program Example

```
PRINT #1, CHR$(&H1D);"D";CHR$(3);CHR$(0);CHR$(20);CHR$(2);CHR$(0); ←Set disabled
PRINT #1, CHR$(&H1B);"*";CHR$(0);CHR$(9);CHR$(0);CHR$(240);CHR$(15);
PRINT #1, CHR$(16);CHR$(20);CHR$(2);CHR$(1);CHR$(8); ←Process as image data
PRINT #1, CHR$(15);CHR$(240);"END";CHR$(&HA); ←Execute print and line feed
PRINT #1, CHR$(&H1D);"D";CHR$(3);CHR$(0);CHR$(20);CHR$(2);CHR$(1); ←Set enabled
PRINT #1, CHR$(16);CHR$(20);CHR$(2);CHR$(1);CHR$(8); ←Execute power off
GOSUB *RECEIVE                               ←Confirmation "power off notice"
```

[Name] Request transmission of response or status

[Printers not featuring this command] **TM-J2000/J2100**, **TM-U230**, **TM-U220**

[Description] Various process are performed as the response.

- **pL**, **pH** specifies (**pL** + **pH** × 256) as the number of bytes after **pH** (**fn** and **m**).
- Function code **fn** specifies the type of response control.

<b>fn</b>	<b>Function</b>	
48	Function 48	Specifies the process ID response.
49	Function 49	Specifies the offline response.

- [Notes]
- Do not use this command in a system in which the printer is used with the OPOS driver and Java POS driver that are provided by Seiko Epson Corporation.
  - The function of this command is defined by function code **fn** and the operation differs depending on the function selected.
  - "Response" is a data block to inform the host of the processing status. There are three kinds of "Response" as shown in the following table. Untransmitted multi-kind responses are stored in the printer and transmitted in the order of priority shown in the following table, ignoring the order of occurrence.

<b>Kind of Response</b>	<b>Related Command</b>	<b>Priority</b>
Process ID response	<Function 48> of this command	1
Offline response	<Function 49> of this command	2
Clear response 25	<b>DLE DC4 (fn = 8)</b>	3

## Notes for response transmission process

- When the host PC isn't able to receive when the response is transmitted, the response is reserved and the printer starts processing the next data. The reserved response is processed again at the next time for transmitting responses.
  - When specifying any response with a serial interface, make sure that the host PC is able to receive data. When host is unable to receive data, responses cannot be received correctly.
- When operating with a parallel interface, the data sent by this function (starting with Header and ending with NUL), as with other data, is first stored in the send buffer, then output in sequential order when the host computer changes to the reverse mode. Note that the send buffer capacity is 99 bytes, and any data exceeding this volume limit will be lost; therefore, when using this command, it is important to configure the operation so that the host computer's change to the reverse mode and the subsequent status send/receive process is performed quickly.
- The printer enters the BUSY state just before the data header is sent. After NUL has been sent, the printer enters the READY state (except when other factors cause it to enter the BUSY state).
- When communication with the printer uses XON/XOFF control with a serial interface, the XOFF code may interrupt the "Header to NUL" data string.
- The response for each function can be identified to other transmission data according to specific data of the transmission data block. When the header transmitted by the printer is [hex = 37H/decimal =55], treat NUL [hex = 00H/decimal =0] as a data group and identify it according to the combination of the header and the identifier.

## Program Example

```
PRINT #1, CHR$( &H1D ); " (G"; CHR$(3); CHR$(0); CHR$(49); CHR$(48); CHR$(1); ← specifies the offline response  
                                                                    [function 48]  
PRINT #1, "AAAAA"; CHR$( &HA ); ← Print data on paper  
PRINT #1, CHR$( &H1D ); " (G"; CHR$(2); CHR$(0); CHR$(82); CHR$(48); ← Pre-process for cut sheet insertion ends  
                                                                    [function 82]  
PRINT #1, CHR$( &H1D ); " (H"; CHR$(6); CHR$(0); CHR$(48); CHR$(48); "0001" ← Specifies process ID    [function 48]  
PRINT #1, "BBBBB"; CHR$( &HA ); ← Print data on paper  
PRINT #1, CHR$( &H1D ); " (H"; CHR$(6); CHR$(0); CHR$(48); CHR$(48); "0002" ← Specifies process ID    [function 48]  
PRINT #1, CHR$( &H1D ); " (V"; CHR$(66); CHR$(0); ← Cutting paper
```

## Print Example

```
Print sample  
  
AAAAA                ←The process ID response (0001)  
BBBBB                ←The process ID response (0002)  
— — — — — — — — — — ←Paper cutting
```

[Model-dependent variations]

**TM-T90, TM-L90, TM-T88IV, TM-T70, TM-P60**

**TM-T90, TM-L90**

**The printer supports all functions.**

**TM-T88IV, TM-T70, TM-P60**

**The printer supports function 48.**

## GS ( H *p<sub>L</sub>* *p<sub>H</sub>* *fn* *m* *d1* *d2* *d3* *d4* <Function 48>

---

[Format]	ASCII	GS (	H	<b>p<sub>L</sub></b>	<b>p<sub>H</sub></b>	<b>fn</b>	<b>m</b>	<b>d1</b>	<b>d2</b>	<b>d3</b>	<b>d4</b>
	Hex	1D 28	48	06	00	30	30	<b>d1</b>	<b>d2</b>	<b>d3</b>	<b>d4</b>
	Decimal	29 40	72	6	0	48	48	<b>d1</b>	<b>d2</b>	<b>d3</b>	<b>d4</b>

[Range] **(p<sub>L</sub> + p<sub>H</sub> × 256) = 6(p<sub>L</sub> = 6, p<sub>H</sub> = 0)**  
**fn = 48**  
**m = 48**  
**32 ≤ d1 ≤ 126**  
**32 ≤ d2 ≤ 126**  
**32 ≤ d3 ≤ 126**  
**32 ≤ d4 ≤ 126**

[Description] Saves the specified process ID related to the processed data just before this function.

- **(d1, d2, d3, d4)** specifies the process ID. The process ID is able to be related to printing data and any command data without a real-time command.
- When the related data is processed, the process ID is transmitted to the host PC.

[Notes] ■ The time when the response is transmitted differs depending on the related data.

- When the related data is printing data, the process ID response is transmitted when the printing is completed.
- When the related data is any data without the commands described above, the process ID response is transmitted at the time of processing the data.

- Process ID response is the “header to NUL” data shown below:

Send data	Hex	Decimal	Data quantity
Header	37H	55	1 byte
Identifier	22H	34	1 byte
Process ID <sup>(*1)</sup>	20H ~ 7EH	32 ~ 126	4 byte
NUL	00H	0	1 byte

(\*1)[Process ID] is same data as the parameters of this function (**d1, d2, d3, d4**).

- Process ID (**d1, d2, d3, d4**) is specified by a character string data format. When the strings are specified in ascending order (“0001” ~ “9999”), confirming for the processing order becomes easy.
- When the transmitting of a process ID response occurs while some untransmitted process ID is being stored, the printer transmits the latest process ID only.  
Example:  
There are three lines of printing data, and a process ID (“0001,” “0002,” and “0003”) is specified for each line. (When the host receives the process ID response “0003,” the host can judge that “the three line printing is completed.”)
  - When the host PC is always able to receive data from the printer, the printer transmits three process ID responses (“0001,” “0002,” “0003”).
  - When the host PC isn’t able to receive data from the printer when the second line of printing is done, the printer transmits two process ID responses (“0001,” “0003”).
  - When the host PC isn’t able to receive data from the printer when the first and second lines of printing are done, the printer transmits one process ID response (“0003”).
- When unprocessed data is cleared by **DLE DC4 (fn = 8)** or “Recovers from an error after clearing the receive and print buffers” of **DLE ENQ (n = 2)** or others, it is cleared without transmitting the process IDs that are related to the cleared data.
- When specifying process an ID response by this function, execute response confirmation processing on the host PC for the responses from the printer.

# CONFIDENTIAL

- **See program example and print sample for ESC i and ESC m** for description of the response transmission process.



## GS ( H *pL pH fn m d* <Function 49>

---

[Format]      ASCII      GS (    H    **pL** **pH** **fn** **m** **d**  
                  Hex      1D 28 48 03 00 31 30 **d**  
                  Decimal 29 40 72 3 0 49 48 **d**

[Range]      (**pL** + **pH** × 256) = 3(**pL** = 3, **pH** = 0)  
**fn** = 49  
**m** = 48  
0 ≤ **d** ≤ 2, 48 ≤ **d** ≤ 50

[Default]      **d** = 0

[Description] Specifies or turns off the offline response transmission.

<b>d</b>	Function
0, 48	Turns off the offline response transmission.
1, 49	Specifies the offline response transmission (not including the offline cause).
2, 50	Specifies the offline response transmission (including the offline cause).

When specifying offline response transmitting (**d** = 1, 2, 49, 50), offline response is transmitted when the printer goes offline for any of the following causes.

- Any paper cover open
- Printing stop because of paper out
- Automatically recoverable error
- Recoverable error
- Unrecoverable error

[Notes]      ■ Confirm that untransmitted offline responses aren't stored in the printer when specifying or turning off offline response transmitting by this function.

- When operating with a serial interface, make sure that the host PC is able to receive data before executing this function.
  - When operating with a parallel interface, change the host PC to the reverse mode for confirming any responses.
- Offline response is the “header to NUL” data shown below:

Send data	Hex	Decimal	Data quantity
Header	37H	55	1 byte
Identifier	23H	35	1 byte
Offline cause <sup>(*1)</sup>	40H ~ 7FH	64 ~ 127	0 ~ 10 byte
NUL	00H	0	1 byte

- (\*1) When specifying (**d** = 1, 49), [Offline cause] is not added. Details of the offline cause differ, depending on each model.
- When transmitting an offline response occurs at the same time that an untransmitted offline response is being stored, the printer transmits the latest offline response only.
  - You can get detailed information of offline occurrences by using the combination of ASB status and offline response with offline cause.
  - When specifying offline response by this function, execute response confirmation processing on the host PC for the responses from the printer.
  - **See program example and print sample for ESC i and ESC m** for description of response transmission process.

[Model-dependent variations]

**TM-T90, TM-T88IV, TM-T70, TM-L90, TM-P60**

# CONFIDENTIAL

## TM-T90

The offline cause of this printer is constructed of 5 bytes as shown in the following tables.

<The first byte: information for unrecoverable error>

Bit	Off/On	Hex	Decimal	Information
0	Off	00	0	CPU execution error hasn't occurred.
	On	01	1	CPU execution error has occurred.
1	Off	00	0	ROM error hasn't occurred in the memory.
	On	02	2	ROM error has occurred in the memory.
2	Off	00	0	G/A error hasn't occurred in the gate array.
	On	04	4	G/A error has occurred in the gate array.
3 ~ 5	-	-	-	Reserved.
6	On	40	64	Fixed.
7	0	00	0	Fixed.

When one of the above errors occurs, turn off the printer immediately.

<The second byte: information for unrecoverable errors>

Bit	Off/On	Hex	Decimal	Information
0	Off	00	0	High voltage error hasn't occurred.
	On	01	1	High voltage error has occurred.
1	Off	00	0	Low voltage error hasn't occurred.
	On	02	2	High voltage error has occurred.
2	Off	00	0	Overcurrent error hasn't occurred.
	On	02	2	Overcurrent error has occurred.

## <The second byte: information for unrecoverable errors>

Bit	Off/On	Hex	Decimal	Information
3 ~ 5	-	-	-	Reserved.
6	On	40	64	Fixed.
7	0	00	0	Fixed.

When one of above errors occurs, turn off the printer immediately.

## <The third byte: information for unrecoverable errors>

Bit	Off/On	Hex	Decimal	Information
0	Off	00	0	Thermostat error hasn't occurred.
	On	01	1	Thermostat error has occurred.
1 ~ 5	-	-	-	Reserved.
6	On	40	64	Fixed.
7	Off	00	0	Fixed.

When one of above errors occurs, turn off the printer immediately.

<The fourth byte: information for recoverable error>

Bit	Off/On	Hex	Decimal	Information
0	Off	00	0	Autocutter error hasn't occurred.
	On	01	1	Autocutter error has occurred.
1	Off	00	0	Roll paper cover open error hasn't occurred. (When Msw [8-8] is ON)
	On	02	2	Roll paper cover open error hasn't occurred. (When Msw [8-8] is ON)
2~5	-	-	-	Reserved.
6	On	40	64	Fixed.
7	0	00	0	Fixed.

When one of above errors occurs, the error can be canceled by executing DLE ENQ (n=2) after clearing the error cause.

<The fifth byte: information for unrecoverable error>

Bit	Off/On	Hex	Decimal	Function
0	Off	00	0	Roll paper cover open error hasn't occurred. (When Msw [8-8] is OFF)
	On	01	1	Roll paper cover open error has occurred. (When Msw [8-8] is OFF)
2 ~ 5	-	-	-	Reserved.
6	On	40	64	Fixed.
7	0	00	0	Fixed.

When the error of bit 0 occurs, the error can be canceled by closing the roll paper cover.

When the error of bit 1 occurs, the error is automatically canceled when the temperature of the print head returns to the specified temperature range.

## TM-L90

For the **TM-L90** with Peeler, this function applies to the roll paper cover.

# CONFIDENTIAL

The offline cause of this printer is constructed of 5 bytes as shown in the following tables.

## <The first byte: information for unrecoverable error>

Bit	Off/On	Hex	Decimal	Information
0	Off	00	0	CPU execution error hasn't occurred.
	On	01	1	CPU execution error has occurred.
1	Off	00	0	ROM error hasn't occurred in the memory.
	On	02	2	ROM error has occurred in the memory.
2	Off	00	0	G/A error hasn't occurred in the gate array.
	On	04	4	G/A error has occurred in the gate array.
3 ~ 5	-	-	-	Reserved.
6	On	40	64	Fixed.
7	0	00	0	Fixed.

When one of above errors occurs, turn off the printer immediately.

## <The second byte: information for unrecoverable errors>

Bit	Off/On	Hex	Decimal	Information
0	Off	00	0	High voltage error hasn't occurred.
	On	01	1	High voltage error has occurred.
1	Off	00	0	Low voltage error hasn't occurred.
	On	02	2	High voltage error has occurred.
2	Off	00	0	Over current error hasn't occurred.
	On	02	2	Over current error has occurred.

**<The second byte: information for unrecoverable errors>**

Bit	Off/On	Hex	Decimal	Information
3 ~ 5	-	-	-	Reserved.
6	On	40	64	Fixed.
7	0	00	0	Fixed.

When one of above errors occurs, turn off the printer immediately.

**<The third byte: information for unrecoverable errors>**

Bit	Off/On	Hex	Decimal	Information
0	Off	00	0	Thermostat error hasn't occurred.
	On	01	1	Thermostat error has occurred.
1 ~ 5	-	-	-	Reserved.
6	On	40	64	Fixed.
7	Off	00	0	Fixed.

When one of above errors occurs, turn off the printer immediately.



## <The fourth byte: information for recoverable error>

Bit	Off/On	Hex	Decimal	Information
0	Off	00	0	Autocutter error hasn't occurred.
	On	01	1	Autocutter error has occurred.
1	Off	00	0	Roll paper cover open error hasn't occurred. (When Msw [8-8] is ON)
	On	02	2	Roll paper cover open error hasn't occurred. (When Msw [8-8] is ON)
2	Off	00	0	Roll paper layout error hasn't occurred.
	On	04	4	Roll paper layout error hasn't occurred.
3~5	-	-	-	Reserved.
6	On	40	64	Fixed.
7	0	00	0	Fixed.

Bit 0 is not supported by the **TM-L90** with Peeler.

When the error of bit 0 or bit 1 occurs, the error can be canceled by executing DLE ENQ ( $n = 2$ ) after clearing the error cause.

When the error of bit 2 occurs, the error can be canceled by either of the following. See the printer information of function 3 of **GS ( E** for memory switches details.

When memory switch [Msw8-2] is OFF: execution of DLE ENQ ( $n = 2$ ) or opening/closing the cover

When memory switch [Msw8-2] is ON: execution of DLE ENQ ( $n = 2$ )

When memory switch [Msw8-1] is OFF: execution of DLE ENQ ( $n = 2$ ) or pressing the FEED button

# CONFIDENTIAL

[TM-L90 with Peeler]

When memoery switch [Msw8-1] is ON: execution of **DLE ENQ (n = 2)** [TM-L90 with Peeler]

<The fifth byte: information for unrecoverable error>

Bit	Off/On	Hex	Decimal	Function
0	Off	00	0	Roll paper cover open error hasn't occurred. (When Msw [8-8] is OFF)
	On	01	1	Roll paper cover open error has occurred. (When Msw [8-8] is OFF)
2 ~ 5	-	-	-	Reserved.
6	On	40	64	Fixed.
7	0	00	0	Fixed.

When the error of bit 0 occurs, the error can be canceled by closing the roll paper cover.

When the error of bit 1 occurs, the error is automatically canceled when the temperature of the print head returns to the specified temperature range.

**TM-T88IV**, **TM-T70**, **TM-P60**

The printer does not support this function.

[Name] Select print control method(s)

[Printers not featuring this command] **TM-U230, TM-U220**

[Description] Selects the print control methods.

- Function code **fn** specifies the function.

fn	Function No.	Function name
48	<b>Function 48</b>	Select the print control mode
49	<b>Function 49</b>	Select the print density
50	<b>Function 50</b>	Select the print speed
97	<b>Function 97</b>	Select the number of parts for the thermal head energizing

- **pl, pH** specifies (**pl** + **pH** × 256) as the number of bytes after **pH** (**fn** and **[parameters]**). The **[parameters]** are described in each function.

### [Notes]

- This command decides the function according to the function code (**fn**). Performance of the functions differs, depending on the function.
- The settings of this command are effective until **ESC @** is executed, the printer is reset, or the power is turned off.

[Model-dependent variations]

**TM-J2000/J2100, TM-P60, TM-T90, TM-L90, TM-T88IV, TM-T70**

### Program Example

```
PRINT #1, CHR$( &H1D ); " ( K " ; CHR$( 2 ); CHR$( 0 ); CHR$( 048 ); CHR$( 049 ); ← Function 48
```

### **TM-J2000/J2100, TM-P60**

**This printer supports Function 48.**

### **TM-T90, TM-L90**

**The printer supports all functions.**

# CONFIDENTIAL

**TM-T88IV, TM-T70**

This printer supports Function 50 and Function 97.

## GS ( K <Function 48>

[Name] Select the print control mode

[Format] ASCII GS ( K **pL pH fn m**  
 Hex 1D 28 4B 02 **00 30 m**  
 Decimal 29 49 75 2 0 **48 m**

[Range] **TM-J2000/J2100:**  $(pL + pH \times 256) = 2$  ( $pL = 2, pH = 0$ )  
**fn = 48**  
 $1 \leq m \leq 3, 49 \leq m \leq 51$   
**TM-T90:**  $1 \leq m \leq 4, 49 \leq m \leq 52$   
**TM-L90:**  $0 \leq m \leq 4, 48 \leq m \leq 52$   
**TM-P60:**  $m = 49, 50$

[Default] **TM-J2000/J2100: m = 2**  
**TM-T90, TM-L90: m = 1**  
**TM-P60: m = 49**

[Description] Selects the print control mode by **m**.

<b>m</b>	<b>Function</b>
0, 48	Print mode when power is turned on
1, 49	Print control mode 1
2, 50	Print control mode 2
3, 51	Print control mode 3
4, 52	Print control mode 4

- The specification of each print control mode differs, depending on the printer model. See model-dependent variations.

[Notes] None.

[Model-dependent variations] **TM-J2000/J2100, TM-T90, TM-T88IV, TM-T70, TM-L90, TM-P60**

## TM-J2000/J2100

The following print control modes are available.

<b>m</b>	<b>Print control mode</b>	<b>Specification</b>
<b>1, 49</b>	<b>Normal</b>	<b>Enables printing in high density</b>
<b>2, 50</b>	<b>High speed</b>	<b>Enables printing in high speed and saving ink</b>
<b>3, 51</b>	<b>Economy</b>	<b>Prints saving more ink than "High speed"</b>

Bar code mode is in addition to the modes mentioned above. Bar code mode prints the bar code or the 360 dpi graphics and is automatically selected when printing that data. When printing data other than the bar code or the 360 dpi graphics, the printing mode automatically returns to the mode specified by this function.

Even when "high speed" or "economy" is selected, the spool slot might not be improved because of the data communication speed between the printer and the host.

## TM-T90

The following print control modes are available.

<b>m</b>	<b>Print control mode</b>
<b>1, 49</b>	<b>Standard print control mode</b>
<b>2, 50</b>	<b>Suitable print control mode for printing a fence bar code</b>
<b>3, 51</b>	<b>Suitable print control mode for printing a ladder bar code</b>
<b>4, 52</b>	<b>Suitable print control mode for printing a two dimension code</b>

In printing when (**m = 3, 4, 51, 52**), the printer starts actual printing after it reaches control speed. The paper must be fed 10 dots or less in this operation. Therefore, when the printer starts printing, paper feeding for 10 dots or less without printing might occur.

## TM-T88IV, TM-T70

The printer does not support this function.

## TM-L90

The following print control modes are available.

<b>m</b>	<b>Print control mode</b>
<b>0, 48</b>	<b>Print control mode when power supply is turned on</b>
<b>1, 49</b>	<b>Standard print control mode</b>
<b>2, 50</b>	<b>Suitable print control mode for printing a fence bar code</b>
<b>3, 51</b>	<b>Suitable print control mode for printing a ladder bar code</b>
<b>4, 52</b>	<b>Suitable print control mode for printing a two dimension code</b>

This printer selects "Standard print control mode" at setting of (**m = 0,48**).

In printing when **m = 3, 4, 51, or 52**, the printer starts actual printing after it reaches control speed. The paper must be fed 10 dots or less in this operation. Therefore, when the printer starts printing, paper feeding for 10 dots or less without printing might occur.

## TM-P60

The following printing control modes are selectable:

<b>m</b>	<b>Print control mode</b>
<b>49</b>	<b>High speed</b>
<b>50</b>	<b>Fine</b>

When printing ladder bar code (bar code rotated by 90 degrees in page mode) or two dimension code, it is printed with the "printing control mode = fine" regardless of the setting of this command.

# CONFIDENTIAL

## GS ( K <Function 49>

---

[Name] Select the print density

[Format] ASCII GS ( K **pL pH fn m**  
Hex 1D 28 4B **02 00 31 m**  
Decimal 29 49 75 **2 0 48 m**

[Range]  $(pL + pH \times 256) = 2$  (**pL = 2, pH = 0**)  
**fn = 49**  
**TM-T90:**  $250 \leq m \leq 255, 0 \leq m \leq 6$   
**TM-L90:**  $250 \leq m \leq 255, 0 \leq m \leq 8$

[Default] **m = 0**

[Description] Selects the print density by **m**.

<b>m</b>	<b>Function</b>
128 - 255	Pale density
0	Standard density [setting value of <b>GS ( E</b> Function 5 customize value ( <b>a = 5</b> ) ]
1 - 127	Strong density

- The specification of each print density differs, depending on the printer model. See model-dependent variations.

[Notes] ■ When a standard mode is selected, all the data in a line is printed in the same density.  
■ When a page mode is selected, all the data printed collectively by **FF** or **ESC FF** is printed in the same density.

[Model-dependent variations] **TM-J2000/J2100, TM-T88IV, TM-T70, TM-T90, TM-L90, TM-P60**

**TM-J2000/J2100, TM-T88IV, TM-T70, TM-P60**

**This printer does not support this function.**



## TM-T90

The following print densities are available.

<b>m</b>	<b>Print density</b>
<b>250</b>	<b>Criterion density × 70%</b>
<b>251</b>	<b>Criterion density × 75%</b>
<b>252</b>	<b>Criterion density × 80%</b>
<b>253</b>	<b>Criterion density × 85%</b>
<b>254</b>	<b>Criterion density × 90%</b>
<b>255</b>	<b>Criterion density × 95%</b>
<b>0</b>	<b>Criterion density</b>
<b>1</b>	<b>Criterion density × 105%</b>
<b>2</b>	<b>Criterion density × 110%</b>
<b>3</b>	<b>Criterion density × 115%</b>
<b>4</b>	<b>Criterion density × 120%</b>
<b>5</b>	<b>Criterion density × 125%</b>
<b>6</b>	<b>Criterion density × 130%</b>

A criterion density is the print density set by Function 5 (a = 5) of **GS ( E)**.

The print density actually set is as follows.

**For Example:** If (m = 4) is specified when 90% in a standard density is set, the print density becomes 110% [90%×120%].

The print density can be only within the range of 70% to 130%. When it is set to exceed 130%, the print density becomes 70% or 130%.

**For example:** If (m = 6) is specified at 120% in a standard density, the print density becomes 130% though the calculated value is 150% [120%×130%].

# CONFIDENTIAL

## TM-L90

The following print densities are available.

<b>m</b>	<b>Print density</b>
<b>250</b>	<b>Criterion density × 70%</b>
<b>251</b>	<b>Criterion density × 75%</b>
<b>252</b>	<b>Criterion density × 80%</b>
<b>253</b>	<b>Criterion density × 85%</b>
<b>254</b>	<b>Criterion density × 90%</b>
<b>255</b>	<b>Criterion density × 95%</b>
<b>0</b>	<b>Criterion density</b>
<b>1</b>	<b>Criterion density × 105%</b>
<b>2</b>	<b>Criterion density × 110%</b>
<b>3</b>	<b>Criterion density × 115%</b>
<b>4</b>	<b>Criterion density × 120%</b>
<b>5</b>	<b>Criterion density × 125%</b>
<b>6</b>	<b>Criterion density × 130%</b>
<b>7</b>	<b>Criterion density × 135%</b>
<b>8</b>	<b>Criterion density × 140%</b>

A criterion density is the print density set by Function 5 (a = 5) of GS ( E).

The print density actually set is as follows.

For Example: If (m = 4) is specified when 90% in a standard density is set, the print density becomes 110% [90%×20%].

The print density can be only within the range of 70% to 130%. When it is set to exceed 130%, the print density becomes 70% or 130%.

For example: If (m = 6) is specified at 120% in a standard density, the print density becomes 130% though the calculated value is 150% [120%×130%].

## GS ( K <Function 50>

[Name] Select the print speed

[Format] ASCII GS ( K **pL pH fn m**  
 Hex 1D 28 4B **02 00 32 m**  
 Decimal 29 40 75 **2 0 50 m**

[Range] (**pL** + **pH** × 256) = 2 (**pL** = 2, **pH** = 0)  
**fn** = 50

**TM-T90:** 0 ≤ **m** ≤ 11 48 ≤ **m** ≤ 57 (Japanese model)  
 0 ≤ **m** ≤ 9 48 ≤ **m** ≤ 57 (Other than Japanese model)  
**TM-T88IV, TM-T70, TM-L90:** 0 ≤ **m** ≤ 9, 48 ≤ **m** ≤ 57

[Default] **m** = 0

[Description] Selects the print speed by **m**.

<b>m</b>	<b>Function</b>
0, 48	Setting value of <b>GS ( E</b> Function 5 customize value ( <b>a</b> = 6)
1, 49	Print speed level 1 (The lowest speed)
2, 50	Print speed level 2
:	:
8, 56	Print speed level 8
9, 57	Print speed level 9
10	Print speed level 10
11	Print speed level 11

- The specification of each print speed differs, depending on the printer model. See model-dependent variations.

[Notes] ■ The set value of this function specifies the print speed when operating under proper conditions. It may be slower than the set print speed temporarily depending on conditions such as the operation environment and the print duty.

# CONFIDENTIAL

- When a standard mode is selected, all the data in the line is printed in the same speed.
- When a page mode is selected, all the data printed collectively by **FF** or **ESC FF** is printed at the same speed.

[Model-dependent variations]

**TM-J2000/J2100**, **TM-P60**, **TM-T88IV**, **TM-T70**, **TM-L90**

**TM-J2000/J2100**, **TM-P60**

**This printer does not support this function.**

**TM-T88IV**, **TM-T70**

See the **GS ( E <Function 5:(a=6)>** model information for details of the printing speed level.

**TM-L90**

**TM-L90 with Peeler**

**When the peeling issuing mode is selected, select a print speed slower than level 6 (120mm/s).**

# CONFIDENTIAL

## GS ( K <Function 97>

---

[Name] Select the number of parts for the thermal head energizing

[Format] ASCII GS ( K **pL pH fn m**  
Hex 1D 28 4B **02 00 61 m**  
Decimal 29 40 75 **2 0 97 m**

[Range] (**pL** + **pH** × 256) = 2 (**pL** = 2, **pH** = 0)  
**fn** = 97

**TM-T90, TM-L90: 0 ≤ m ≤ 4, 48 ≤ m ≤ 52**

**TM-T88IV: 0 ≤ m ≤ 2, 48 ≤ m ≤ 50, m = 4, 52, 128**

**TM-T70: 0 ≤ m ≤ 2, 48 ≤ m ≤ 50, m = 4, 52, 128 [Other than Japanese model]**

**0 ≤ m ≤ 2, 48 ≤ m ≤ 50, m = 128 [Japanese model]**

[Default] **m** = 0

[Description] Selects the number of parts for the thermal head energizing which **m** specifies.

<b>m</b>	<b>Function</b>
0, 48	Setting value of <b>GS ( E</b> Function 5 customize value ( <b>a</b> = 97)
1, 49	One-part energizing
2, 50	Two-part energizing
3, 51	Three-part energizing
4, 52	Four-part energizing
128	Automatic control

- The specification of each thermal head energizing differs, depending on the printer model. See model-dependent variations.

[Notes] ■ When the standard mode is selected, all the data in a line is printed with the same setting.

- When the page mode is selected, all the data printed collectively by **FF** or **ESC FF** is printed with the same setting.

[Model-dependent variations] **TM-J2000/J2100, TM-P60, TM-T90, TM-L90, TM-T88IV, TM-T70**

# CONFIDENTIAL

## **TM-J2000/J2100, TM-P60**

**This printer does not support this function.**

## **TM-T90, TM-L90**

**We recommend setting "Selects energizing division into two" for best printing condition with two-color printing.**

## **TM-T88IV, TM-T70**

See the **GS ( E <Function 5:(a=97)>** model information for details of head energizing strokes.

[Name] Page mode control

[Printers not featuring this command] **TM-J2000/J2100**, **TM-T90**, **TM-T88IV**, **TM-T70**, **TM-L90**, **TM-U220**, **TM-U230**

[Description] Executes various controls regarding page mode.

- The function is specified with the function code (**fn**).

<b>fn</b>	<b>Function No.</b>	<b>Function name</b>
48	<b>Function 48</b>	Printable area setting when page mode is selected

- **pL** and **pH** specify the number of bytes following fn as (**pL** + **pH** × 256).
- [parameter] is covered in the description of each function.

[Notes] ■ With this command, the function is decided by the function code (**fn**). The detailed operation differs with each function.

### Program example

```
PRINT #1, CHR$( &h1D ); " ( P "; CHR$( 8 ); CHR$( 0 ); CHR$( 48 ); ← <Function 48>
PRINT #1, CHR$( 255 ); CHR$( 255 );
PRINT #1, CHR$( 144 ); CHR$( 1 ); ← Sets the vertical size of the printable area to 400 when the page mode is selected
PRINT #1, CHR$( 0 ); CHR$( 0 );
PRINT #1, CHR$( 1 );
```

## <Function 48> GS ( P pL pH fn wxL wxH wyL wyH oXL oXH c

---

[Name]	Printable area setting when page mode is selected
[Format]	ASCII GS ( P pL pH fn wxL wxH wyL wyH oXL oXH c Hex 1D 28 50 08 00 30 wxL wxH wyL wyH oXL oXH c Decimal 29 40 80 8 0 48 wxL wxH wyL wyH oXL oXH c
[Range]	$(pL + pH \times 256) = 8$ ( $pL = 8, pH = 0$ ) <b>fn = 48</b> <b>TM-P60:</b> $(wxL + wxH \times 256) = 65535$ ( $wyL = 255, wxH = 255$ ) $1 \leq (wyL + wyH \times 256) \leq 65535$ ( $0 \leq wyL \leq 255, 0 \leq wyH \leq 255$ ) $(oXL + oXH \times 256) = 0$ ( $oXL = 0, oXH = 0$ ) <b>c = 1</b>
[Default]	<b>TM-P60:</b> $(wxL + wxH \times 256) = 65535$ ( $wxL = 255, wxH = 255$ ) $(wyL + wyH \times 256) = 1200$ ( $wyL = 176, wyH = 4$ ) $(oXL + oXH \times 256) = 0$ ( $oXL = 0, oXH = 0$ ) <b>c = 1</b>
[Description]	Sets the printable area when page mode is selected. <ul style="list-style-type: none"> <li>• Sets the horizontal size to <math>[(wxL + wxH \times 256) \times \text{horizontal and vertical motion units}]</math> from the horizontal offset.</li> <li>• Sets the vertical size to <math>[(wyL + wyH \times 256) \times \text{horizontal and vertical motion units}]</math> from the absolute origin.</li> <li>• Sets the horizontal offset to the <math>[(oXL + oXH \times 256) \times \text{horizontal and vertical motion units}]</math> position.</li> </ul>
[Notes]	<ul style="list-style-type: none"> <li>■ Use this function when the standard mode is selected.</li> <li>■ In this function, horizontal indicates “perpendicular to the feed direction,” while vertical indicates “the feed direction.”</li> <li>■ A horizontal size or vertical size of 0 cannot be set.</li> <li>■ The horizontal motion unit is used to calculate the horizontal size and horizontal offset.</li> <li>■ The vertical motion unit is used to calculate the vertical size.</li> </ul>



- If the maximum settable area is exceeded, the following corrective action is taken.
  - If the specified horizontal size exceeds the maximum settable area [horizontal size = maximum value for the printable area] is set.
  - If the specified (horizontal offset + horizontal size) exceeds the maximum settable area [horizontal offset = (maximum value for the printable area - horizontal size)] is set.
  - If the specified vertical size exceeds 1,016 mm {40 inches}, [vertical size = 1,016 mm {40 inches}] is set.
  - If the maximum value for the area size specified by the model is exceeded, the corrective action specified by the model is executed.
- If the horizontal and vertical motion units are changed after the printable area is set, the printable area set does not change.
- When using the page mode with models that support this function, the following rules apply.
  - The printable area set with this function is the maximum value for the area that can be specified with **ESC W**.
  - The top left of the printable area set with this function is treated as the absolute origin of ESC W.
  - If the printable area is changed with this function, after executing **ESC L** and **FS L**, set the printing area to the same size as that specified in **ESC W** with this function.
- The setting value of this function is valid until **ESC @ESC @**, reset, or power off are executed.
- Settings of this function do not affect printing in standard mode.

[Model-dependent variations]

## TM-P60

### TM-P60

The vertical and horizontal motion units are about 0.125 mm {1/203 inch}. This corresponds to 1 dot pitch.

For this printer, the horizontal size of the printable area cannot be changed with this command. Always specify [(w<sub>XL</sub> + w<sub>XH</sub> × 256) = 65535]. The horizontal size of the printable area is decided by the setting value for FS ( L <Function 33> paper layout (sm or sf). See the FS ( L <Function 33> model information for details.

# CONFIDENTIAL

If the specified vertical size exceeds 150 mm {1200/203 inch}, [vertical size ( $wyL + wyH \times 256$ ) = 1200] is set.

Also by specifying ( $wyL + wyH \times 256$ ) = 400) vertical size as 50 mm or less {400/203 inch}, you can shorten processing time when printing data repeatedly using page mode.

The horizontal offset cannot be changed for this printer. Always specify [( $oxL + oxH \times 256$ ) = 0].

[Name] Commands for drawing graphics

[Printers not featuring this command] **TM-J2000/J2100**, **TM-T90**, **TM-T88IV**, **TM-T70**, **TM-L90**, **TM-U230**, **TM-U220**

[Description] Executes various controls regarding drawing graphics.

- The function is specified with the function code (**fn**).

<b>fn</b>	Function No.	Function name
48	<b>Function 48</b>	Draw line
49	<b>Function 49</b>	Draw rectangle

- **pL** and **pH** specify the number of bytes following **fn** as (**pL** + **pH** × 256).
- **[parameter]** is covered in the description of each function.

# CONFIDENTIAL

[Notes] With this command, the function is decided by the function code (**fn**). The detailed operation differs with each function.

## Program example

```
PRINT #1, CHR$(&h1B);"L"; ← Select page mode
PRITN #1, CHR$(&h1B);"W";CHR$(0);CHR$(0);CHR$(0);CHR$(0);
PRITN #1, CHR$(144);CHR$(1);CHR$(88);CHR$(2);
PRINT #1, CHR$(&h1B);"T";CHR$(0); ← Select print direction

PRINT #1, CHR$(&h1D);"(Q";CHR$(14);CHR$(0);CHR$(49); ← <Function 49>
  PRITN #1, CHR$(0);CHR$(0);CHR$(0);CHR$(0); ← Start coordinate
  PRITN #1, CHR$(100);CHR$(0);CHR$(100);CHR$(0); ← End coordinate
  PRITN #1, CHR$(1);CHR$(1);CHR$(48);CHR$(48);CHR$(1); ← Other designations
PRINT #1, CHR$(&h1D);"(Q";CHR$(12);CHR$(0);CHR$(48); ← <Function 48>
  PRITN #1, CHR$(0);CHR$(0);CHR$(10);CHR$(0); ← Start coordinate
  PRITN #1, CHR$(100);CHR$(0);CHR$(10);CHR$(0); ← End coordinate
  PRITN #1, CHR$(1);CHR$(3);CHR$(48); ← Other designations

PRINT #1, CHR$(&h1B);CHR$(&hC); ← Batch printing
PRINT #1, CHR$(&h1B);"S"; ← Select standard mode
```

## Print results

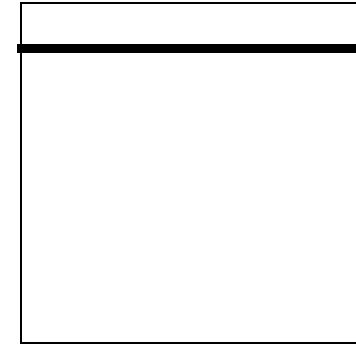

[Model-dependent variations]

**TM-P60**

**TM-P60 with Peeler supports this function.**

## <Function 48> **GS ( Q pL pH fn x1L x1H y1L y1H x2L x2H y2L y2H c m1 m2**

[Name] Draw line

[Format] ASCII GS ( Q pL pH fn x1L x1H y1L y1H x2L x2H y2L y2H c m1 m2  
 Hex 1D 28 51 0C 00 30 x1L x1H y1L y1H x2L x2H y2L y2H c m1 m2  
 Decimal 29 40 81 12 0 48 x1L x1H y1L y1H x2L x2H y2L y2H c m1 m2

[Range] (**pL + pH** × 256) = 12 (**pL** = 12, **pH** = 0)  
**fn** = 48

**TM-P60:** When the start position specified with ESC T is "top left or bottom right":  
 $0 \leq (x1L + x1H \times 256) \leq 431$  ( $0 \leq x1L \leq 255, x1H = 0, 1$ )  
 $0 \leq (y1L + y1H \times 256) \leq 1199$  ( $0 \leq y1L \leq 255, 0 \leq y1H \leq 4$ )  
 $0 \leq (x2L + x2H \times 256) \leq 431$  ( $0 \leq x2L \leq 255, x2H = 0, 1$ )  
 $0 \leq (y2L + y2H \times 256) \leq 1199$  ( $0 \leq y2L \leq 255, 0 \leq y2H \leq 4$ )  
 When the start position specified with ESC T is "bottom left or top right":  
 $0 \leq (x1L + x1H \times 256) \leq 1199$  ( $0 \leq x1L \leq 255, 0 \leq x1H \leq 4$ )  
 $0 \leq (y1L + y1H \times 256) \leq 431$  ( $0 \leq y1L \leq 255, y1H = 0, 1$ )  
 $0 \leq (x2L + x2H \times 256) \leq 1199$  ( $0 \leq x2L \leq 255, 0 \leq x2H \leq 4$ )  
 $0 \leq (y2L + y2H \times 256) \leq 431$  ( $0 \leq y2L \leq 255, y2H = 0, 1$ )  
**c** = 1  
**1** ≤ **m1** ≤ **3**  
**m2** = 48

[Description] Saves line data in the print buffer when page mode is selected.

- **x1L, x1H, y1L, y1H** set the line drawing start coordinate [X start position, Y start position] as the start position reference.
  - X start position:  $[(x1L + x1H \times 256) \times \text{horizontal and vertical motion units}]$
  - Y start position:  $[(y1L + y1H \times 256) \times \text{horizontal and vertical motion units}]$

- **x2L, x2H, y2L, y2H** set the line drawing end coordinate [X end position, Y end position] as the start position reference.
  - X end position:  $[(x2L + x2H \times 256) \times \text{horizontal and vertical motion units}]$
  - Y end position:  $[(y2L + y2H \times 256) \times \text{horizontal and vertical motion units}]$
- m1 sets the type of line. The line width differs according to the model (refer to the model information).

m1	Line type
1	Continuous line: Thin
2	Continuous line: Moderately thick
3	Continuous line: Thick

[Notes]

- This function can be used when page mode is selected. Select page mode with **ESC L**.
- You cannot specify a start coordinate [X start position, Y start position] and end coordinate [X end position, Y end position] that exceed the printing area set with **ESC W**.
- You cannot specify a start coordinate [X start position, Y start position] and end coordinate [X end position, Y end position] that are the same coordinate.
- Lines that can be drawn are lines horizontal in relation to characters (Y start position = Y end position) and lines vertical in relation to characters (X start position = X end position). Diagonal lines cannot be specified.
- X and Y and the horizontal and vertical motion units used for the start position specified with **ESC T** are changed as shown in the table below.

<b>ESC T start position</b>	<b>Start position/end position</b>	<b>Horizontal and vertical motion units used</b>
Top left or bottom right	X: Vertical in relation to paper feed direction (horizontal direction of characters)	X: Horizontal (vertical in relation to paper feed direction)
	Y: Paper feed direction (vertical direction of characters)	Y: Vertical (paper feed direction)
Top right or bottom left	X: Paper feed direction (horizontal direction of characters)	X: Vertical (paper feed direction)
	Y: Vertical in relation to paper feed direction (vertical direction of characters)	Y: Horizontal (vertical in relation to paper feed direction)

- If the line width is 2 dots or more, the line is thickened according to the rules shown in the table below, based on the relationship between the specified start coordinate and end coordinate. However, line data that exceeds the printing area is not saved in the print buffer.

<b>Condition 1</b>	<b>Condition 2</b>	<b>Line thickening method</b>
Y start position = Y end position (Lines horizontal in relation to characters)	X start position < X end position	Thickened downward as seen with the start position at top left
	X start position > X end position	Thickened upward as seen with the start position at top left
X start position = X end position (Lines vertical in relation to characters)	Y start position < Y end position	Thickened rightward as seen with the start position at top left
	Y start position > Y end position	Thickened leftward as seen with the start position at top left

- When this function is executed, the printing position does not change.

## **TM-P60**

The vertical and horizontal motion units are about 0.125 mm {1/203 inch}. This corresponds to 1 dot pitch.

The line width of this printer is as shown in the table below.

<b>m1</b>	<b>Line type</b>	<b>Line width</b>
<b>1</b>	<b>Continuous line: Thin</b>	<b>2 dots</b>
<b>2</b>	<b>Continuous line: Moderately thick</b>	<b>4 dots</b>
<b>3</b>	<b>Continuous line: Thick</b>	<b>8 dots</b>



## <Function 49> GS ( Q pL pH fn x1L x1H y1L y1H x2L x2H y2L y2H c m1 m2 m3 m4

[Name] Draw rectangle

[Format] ASCII GS ( Q pL pH fn x1L x1H y1L y1H x2L x2H y2L y2H c m1 m2 m3 m4  
 Hex 1D 28 51 0E 00 31 x1L x1H y1L y1H x2L x2H y2L y2H c m1 m2 m3 m4  
 Decimal 29 40 81 14 0 49 x1L x1H y1L y1H x2L x2H y2L y2H c m1 m2 m3 m4

[Range]  $(pL + pH \times 256) = 14$  ( $pL = 14, pH = 0$ )  
**fn = 49**

**TM-P60:** When the starting position specified with ESC T is "top left or bottom right":  
 $0 \leq (x1L + x1H \times 256) \leq 430$  ( $0 \leq x1L \leq 255, x1H = 0, 1$ )  
 $0 \leq (y1L + y1H \times 256) \leq 1198$  ( $0 \leq y1L \leq 255, 0 \leq y1H \leq 4$ )  
 $0 \leq (x2L + x2H \times 256) \leq 430$  ( $0 \leq x2L \leq 255, x2H = 0, 1$ )  
 $0 \leq (y2L + y2H \times 256) \leq 1198$  ( $0 \leq y2L \leq 255, 0 \leq y2H \leq 4$ )  
 When the starting position specified with ESC T is "bottom left or top right":  
 $1 \leq (x1L + x1H \times 256) \leq 1199$  ( $0 \leq x1L \leq 255, 0 \leq x1H \leq 4$ )  
 $1 \leq (y1L + y1H \times 256) \leq 431$  ( $0 \leq y1L \leq 255, y1H = 0, 1$ )  
 $1 \leq (x2L + x2H \times 256) \leq 1199$  ( $0 \leq x2L \leq 255, 0 \leq x2H \leq 4$ )  
 $1 \leq (y2L + y2H \times 256) \leq 431$  ( $0 \leq y2L \leq 255, y2H = 0, 1$ )  
**c = 1**  
**1 = m1 = 3**  
**m2 = 48**  
**m3 = 48**  
**m4 = 1**

[Description] Saves rectangle data in the print buffer when page mode is selected.

- **x1L, x1H, y1L, y1H** set the rectangle drawing start coordinate [X start position, Y start position] as the start position reference.
  - X start position:  $[(x1L + x1H \times 256) \times \text{horizontal and vertical motion units}]$
  - Y start position:  $[(y1L + y1H \times 256) \times \text{horizontal and vertical motion units}]$
- **x2L, x2H, y2L, y2H** set the rectangle drawing end coordinate [X end position, Y end position] as the start position reference.

- X end position:  $[(x2L + x2H \times 256) \times \text{horizontal and vertical motion units}]$
- Y end position:  $[(y2L + y2H \times 256) \times \text{horizontal and vertical motion units}]$

■ **m1** sets the type of line. The line width differs according to the model (refer to the model information).

<b>m1</b>	<b>Line type</b>
1	Continuous line: Thin
2	Continuous line: Moderately thick
3	Continuous line: Thick

[Notes]

- This function can be used when page mode is selected. Select page mode with **ESC L**.
- You cannot specify a start coordinate [X start position, Y start position] and end coordinate [X end position, Y end position] that exceed the printing area set with **ESC W**.
- You cannot specify [X start position  $\geq$  X end position] or [Y start position  $\geq$  Y end position].
- X and Y and the horizontal and vertical motion units used for the start position specified with **ESC T** are changed as shown in the table below.

ESC T start position	Start position/end position	Horizontal and vertical motion units used
Top left or bottom right	X: Vertical in relation to paper feed direction (horizontal direction of characters)	X: Horizontal (vertical in relation to paper feed direction)
	Y: Paper feed direction (vertical direction of characters)	Y: Vertical (paper feed direction)
Top right or bottom left	X: Paper feed direction (horizontal direction of characters)	X: Vertical (paper feed direction)
	Y: Vertical in relation to paper feed direction (vertical direction of characters)	Y: Horizontal (vertical in relation to paper feed direction)

- If the line width is 2 dots or more, the line is thickened towards the center of the rectangle. However, if the specified rectangle size is smaller than the line width, the line is not thickened in excess of the size of the rectangle.
- When this function is executed, the printing position does not change.

[Model-dependent variations]

## TM-P60

### TM-P60

The vertical and horizontal motion units are about 0.125 mm {1/203 inch}. This corresponds to 1 dot pitch.

The line width of this printer is as shown in the table below.

m1	Line type	Line width
1	Continuous line: Thin	2 dots
2	Continuous line: Moderately thick	4 dots
3	Continuous line: Thick	8 dots

## GS I

[Name]	Transmit printer ID
[Format]	ASCII    GS I <b>n</b> Hex      1D 49 <b>n</b> Decimal 29 73 <b>n</b>
[Range]	<p><b>TM-J2000/J2100:</b> <math>1 \leq n \leq 3, 49 \leq n \leq 51, 65 \leq n \leq 69, n = 112</math></p> <p><b>TM-T90:</b> <math>1 \leq n \leq 3, 49 \leq n \leq 51, 65 \leq n \leq 69, n = 112</math> (Japanese model or memory switch [Msw 8-7] is OFF) <math>1 \leq n \leq 3, 49 \leq n \leq 51, 65 \leq n \leq 69</math> (memory switch [Msw 8-7] is ON)</p> <p><b>TM-T88IV:</b> <math>1, 2, 49, 50, 65 \leq n \leq 69</math></p> <p><b>TM-T70:</b> <math>1, 2, 49, 50, 110, 65 \leq n \leq 69</math></p> <p><b>TM-L90:</b> <math>n = 1, 2, 49, 50, 33, 112, 65 \leq n \leq 69</math> [TM-L90 with Peeler] <math>1 \leq n \leq 3, 49 \leq n \leq 51, 65 \leq n \leq 69, n = 112</math> [TM-L90 models without peeler]</p> <p><b>TM-P60:</b> <math>n = 1, 2, 49, 50, 33, 96, 65 \leq n \leq 69</math></p> <p><b>TM-U230:</b> <math>1 \leq n \leq 3, 49 \leq n \leq 51, 65 \leq n \leq 68</math></p> <p><b>TM-U220:</b> <math>1 \leq n \leq 3, 49 \leq n \leq 51, 65 \leq n \leq 68, n = 33</math></p>
[Default]	None
[Printers not featuring this command]	None
[Description]	Transmits the printer ID or printer information.

- Transmits 1 byte of printer ID, using **n** as follows:

<b>n</b>	<b>Printer ID</b>	<b>Specification</b>
1, 49	Printer model ID	Printer model
2, 50	Type ID	Printer type
3, 51	Version ID	Firmware version

- Transmits specified printer information A, using **n** as follows:

<b>n</b>	<b>Printer ID</b>	<b>Specification</b>
33	Type information	Supported functions
96, 110	See [Printer information]	See [Printer information]

- Transmits specified printer information B, using **n** as follows:

<b>n</b>	<b>Printer ID</b>	<b>Specification</b>
65	Firmware version	Firmware version
66	Maker name	"EPSON"
67	Printer model	Printer model
68	Serial No	Serial No of the printer
69	Font of Language for each country	Japanese: "KANJI JAPANESE"
		Simplified Chinese: "CHINA GB2312" or "CHINA GB18030"
		Traditional Chinese: "TAIWAN BIG-5"
112	See model-dependent variations	See model-dependent variations

[Notes]

- When you use this command, obey the following rules.
  - When the host PC transmits the function data, transmit next data after receiving the corresponding ID from the printer.
  - With a serial interface printer, be sure to use this function when the host can receive data.
  - With a parallel interface printer, data (printer ID, printer information) sent with this command is temporarily stored in the printer send buffer like other transmitted data (except ASB). When the host goes into reverse mode, the printer then sends the data sequentially from the beginning of the send buffer. Send buffer capacity is 99 bytes. Data exceeding this amount is lost; therefore, when using this command, promptly change into reverse mode to start the data receive process.

# CONFIDENTIAL

[Notes for printer ID]

- Each printer ID is composed of 1 byte of data (when  $1 \leq n \leq 3$ ,  $49 \leq n \leq 51$ ).
- Printer model ID differs, depending on the printer model (when  $n = 1, 49$ ).
- Transmits specified printer information, as follows:

Bit	Off/On	Hex	Decimal	Function
0	Off	00	0	Multi-byte character codes are not supported.
	On	01	1	Multi-byte character codes are supported.
1	Off	00	0	Autocutter not installed.
	On	02	2	Autocutter installed.
2	Off	00	0	DM-D (customer display) is not installed.
	On	04	4	DM-D (customer display) is installed.
3	--	--	--	Reserved.
4	Off	00	0	Not used. Fixed to Off.
5	--	--	--	Reserved.
6	Off	00	0	E/P (Endorse printer) not installed
7	Off	00	0	Not used. Fixed to Off.

... *how to use  
this table*

- For the parallel interface model, bit2 is "DM-D (customer display) is not installed."
- There is a one to one correspondence between the version ID and the firmware version when  $n = 3, 51$ . The details differ, depending on the printer model.
- Printer ID is distinguished from other send data by bits 4 and 7. When the data sent from printer after printing **GS I** is "0xx0xxxx" ( $x = 0, 1$ ), the printer processes the data as printer ID.

[Notes for printer information A]

■ Printer information A (**n** = 33, 96) consists of [Header ~ NUL] as shown in the following table:

Transmitted data	Hex	Decimal	Amount of data
Header	3DH	61	1 byte
Identifier(*1)	20H ~ 2FH	32 ~ 47	1 byte
Printer information A	Depends on printer model	Depends on printer model	0 ~ 80 bytes
NUL	00H		1 byte

(\*1) The identifier is transmitted as the transmitted parameter **n** of this command.

Example: When type information is specified (**n** = 33), the identifier is [hex = 21H/decimal = 33].

The printer information A of type information (**n** = 33) is either 1-byte of [First byte], 2 bytes of [First byte] and [Second byte], or 3 bytes of [First byte] to [Third byte] depending on the modes.

<First byte>.

Bit	Off/On	Hex	Decimal	Function
0	Off	00	0	Multi-byte code character (Kanji) is not supported.
	On	01	1	Multi-byte code character (Kanji) is supported.
1	Off	00	0	Autocutter is not installed.
	On	02	2	Autocutter is installed.
2	Off	00	0	DM-D (Customer display) is not connected.
	Off	04	4	DM-D (Customer display) is connected.
3 ~ 5	-	-	-	Reserved.
6	On	40	64	Fixed.
7	Off	00	0	Fixed.

*... how to use  
this table*

- When using parallel interface, the Bit 2 is fixed to 0 "DM-D (Customer display) is not connected."

<Second byte>

Bit	Off/On	Hex	Decimal	Function
0 ~ 5	-	-	-	Multi-byte code character (Kanji) is not supported.
6	On	40	64	Fixed.
7	Off	00	0	Fixed.

*... how to use  
this table*

<Third byte>

Bit	Off/On	Hex	Decimal	Function
0	Off	00	0	No peeler function available.
	On	01	1	Peeler function available.
1 ~ 5	-	-	-	Reserved.
6	On	40	64	Fixed.
7	Off	00	0	Fixed.

*... how to use  
this table*

- When communication with the printer uses XON/XOFF control, the XOFF code may interrupt the "Header to NUL" data string.
- The printer information A can be differentiated by the header of the block data from other transmission data. After outputting **GS I**, if the header transmitted from the printer is [Hex = 3DH/Decimal = 61], data is processed up to NUL [Hex = 00H/Decimal = 0] as the data block, according to the header and identifier.

[Notes for printer information B]



- Each printer information is composed of [header to NUL] (when  $65 \leq n \leq 69$ , or  $n = 112$ ).

Send data	Hex	Decimal	Data
Header	5FH	95	1 byte
Printer information B	Depends on the model	Depends on the model	0 to 80 bytes
NUL	00H	0	1 byte

- If the printer information is not prepared, [Header + NUL] (2 bytes) are sent.
- The firmware version can be confirmed by self test printing. The self test is executed by executing **GS ( A**, or by panel switch operation when power is turned on.
- With serial interface, when communication with the printer uses XON/XOFF control, the XOFF code may interrupt the "Header to NUL" data string.
- Printer information can be identified to other transmission data according to specific data of the transmission data block. When the header transmitted by the printer is [hex = 5FH/decimal =95], treat NUL [hex = 00H/decimal =0] as a data group and identify it according to the following data.

[Model-dependent variations]

**TM-J2000/J2100**, **TM-T90**, **TM-T88IV**, **TM-T70**, **TM-L90**, **TM-P60**, **TM-U230**, **TM-U220**

### Program Example for all printers

```
PRINT #1, CHR$( &H1D ); "I"; CHR$(1); ←Transmits printer ID
```

### TM-J2000/J2100

- **Printer model ID (n = 1, 49)**  
**Hex = 2BH / Decimal = 43**
  - **Type ID (n = 2, 50)**
- Bit 1: The bit indicates [Autocutter is installed] always.**

# CONFIDENTIAL

**Bit 2: [DM-D (Customer display) is connected/not connected] indicates the state of Memory switch 1-6.**

- **Printer model (n = 67)**

**Printer model: TM-J2000 or TM-J2100**

- **Model dependent printer information (n = 112):**

**Transmits 3 bytes data group composed of [header + printer information type B (1 byte) + NUL].**

Bit	Off/On	Hex	Decimal	Function
0	Off	00	0	Black and white model
	On	01	1	Two-color model
1 to 5	-	-	-	Reserved
6	On	40	64	Fixed
7	Off	00	0	Fixed

## TM-T90

- **Printer model ID (n = 1, 49)**

**Hex = 2EH / Decimal = 46 [When Japanese model is used or memory switch [Msw 8-7] is OFF.]**

**Hex = 20H / Decimal = 32 [When memory switch [Msw 8-7] is ON.]**

- **Type ID (n = 2, 50)**

**Bit 1: [Autocutter is installed/not installed] indicates the state of Memory switch 2-2.**

**Bit 2: The bit [DM-D (Customer display) isn't supported].**

- **Version ID (n = 3,51)**

**By the firmware version [When Japanese model is used or memory switch [Msw 8-7] is OFF.]**

**Hex = 46H / Decimal = 70 [When memory switch [Msw 8-7] is ON.]**

- **Printer model (n = 67)**

**Printer model: TM-T90**

# CONFIDENTIAL

- **Model-dependent printer information (n = 112):**

Transmits 4 byte data group composed of [header + DIP switches information (2 bytes) + NUL].

<1st byte of DIP switch information>

Bit	Off/On	Hex	Decimal	Function
0	Off	00	0	DIP switch 1 OFF
	On	01	1	DIP switch 1 ON
1	Off	00	0	DIP switch 2 OFF
	On	02	2	DIP switch 2 ON
2	Off	00	0	DIP switch 3 OFF
	On	04	4	DIP switch 3 ON
3	Off	00	0	DIP switch 4 OFF
	On	08	8	DIP switch 4 ON
4, 5	-	-	-	Reserved
6	On	40	64	Fixed
7	Off	00	0	Fixed

<2nd byte of DIP switch information>

Bit	Off/On	Hex	Decimal	Function
0	Off	00	0	DIP switch 5 OFF
	On	01	1	DIP switch 5 ON
1	Off	00	0	DIP switch 6 OFF
	On	02	2	DIP switch 6 ON
2	Off	00	0	DIP switch 7 OFF
	On	04	4	DIP switch 7 ON

Bit	Off/On	Hex	Decimal	Function
3	Off	00	0	DIP switch 8 OFF
	On	08	8	DIP switch 8 ON
4, 5	-	-	-	Reserved
6	On	40	64	Fixed
7	Off	00	0	Fixed

## TM-L90

### TM-L90 with Peeler:

- Printer model ID (n = 1, 49)

Hex = 4DH / Decimal = 77

- Type ID (n = 2, 50)

Bit 1: Autocutter is not installed.

Bit 2: The bit DM-D (Customer display) isn't supported.

- Type information (n = 33)

Printer type information consists of 3 bytes of [First byte] to [Third byte].

Bit 1 of [First byte]: [Autocutter is installed/not installed] is not supported.

Bit 2 of [First byte]: DM-D (Customer display) isn't supported.

Bit 0 of [Third byte]: When the peeling issuing mode is selected, it is 1, when the continuous issuing mode is selected, it is 0.

The peeling issuing mode and the continuous issuing mode can be selected by a switch on the printer. This is a slide switch that can be used when the roll paper cover is opened.

Printer model (n = 67): [TM-L90]

- Model dependent printer information (n = 112):

Sends 4 byte data group composed of [header + DIP switch information (2 bytes) + NUL].

## <1st byte of DIP switch information>

Bit	Binary	Hex	Decimal	Function
0	0	00	0	DIP switch 1 OFF
	1	01	1	DIP switch 1 ON
1	0	00	0	DIP switch 2 OFF
	1	02	2	DIP switch 2 ON
2	0	00	0	DIP switch 3 OFF
	1	04	4	DIP switch 3 ON
3	0	00	0	DIP switch 4 OFF
	1	08	8	DIP switch 4 ON
4, 5	-	-	-	Reserved
6	1	40	64	Fixed
7	0	00	0	Fixed

## <2nd byte of DIP switch information>

Bit	Binary	Hex	Decimal	Function
0	0	00	0	DIP switch 5 OFF
	1	01	1	DIP switch 5 ON
1	0	00	0	DIP switch 6 OFF
	1	02	2	DIP switch 6 ON
2	0	00	0	DIP switch 7 OFF
	1	04	4	DIP switch 7 ON
3	0	00	0	DIP switch 8 OFF
	1	08	8	DIP switch 8 ON

Bit	Binary	Hex	Decimal	Function
4, 5	-	-	-	Reserved
6	1	40	64	Fixed
7	0	00	0	Fixed

### TM-L90 models without Peeler:

- Printer model ID (n = 1, 49)

Hex = 40H / Decimal = 64

- Type ID (n = 2, 50)

Bit 1: [Autocutter is installed/not installed] indicates the state of Memory switch 2-2.

Bit 2: The bit [DM-D (Customer display) isn't supported].

- Printer model (n = 67)

Printer model: **TM-L90**

- Model dependent printer information (n = 112):

Sends 4 byte data group composed of [header + printer information (2 bytes) + NUL].

<1st byte of DIP switch information>

Bit	Binary	Hex	Decimal	Function
0	0	00	0	DIP switch 1 OFF
	1	01	1	DIP switch 1 ON
1	0	00	0	DIP switch 2 OFF
	1	02	2	DIP switch 2 ON
2	0	00	0	DIP switch 3 OFF
	1	04	4	DIP switch 3 ON
3	0	00	0	DIP switch 4 OFF
	1	08	8	DIP switch 4 ON

# CONFIDENTIAL

Bit	Binary	Hex	Decimal	Function
4, 5	-	-	-	Reserved
6	1	40	64	Fixed
7	0	00	0	Fixed

## <2nd byte of DIP switch information>

Bit	Binary	Hex	Decimal	Function
0	0	00	0	DIP switch 5 OFF
	1	01	1	DIP switch 5 ON
1	0	00	0	DIP switch 6 OFF
	1	02	2	DIP switch 6 ON
2	0	00	0	DIP switch 7 OFF
	1	04	4	DIP switch 7 ON
3	0	00	0	DIP switch 8 OFF
	1	08	8	DIP switch 8 ON
4, 5	-	-	-	Reserved
6	1	40	64	Fixed
7	0	00	0	Fixed

## TM-T88IV

- Printer model ID (n = 1, 49)

Hex = 20H / Decimal = 32

- Type ID (n = 2, 50)

Bits 1 to 3, and 5 and 6 are not supported.

- Printer model (n = 67)

Printer model: **TM-T88IV**

# CONFIDENTIAL

## TM-T70

- **Printer model ID (n = 1, 49)**

Hex = 68H / Decimal = 104

- **Type ID (n = 2, 50)**

Bits 1 to 3, and 5 and 6 are not supported.

- **Printer model (n = 67)**

Printer model: **TM-T70**

- **Model dependent printer information (n = 110):**

Sends 3 byte data group composed of [header + Paper width and resolution (1 byte) + NUL].

Bit	Function	Binary	Hex	Decimal
0	Paper width 80 mm	0	00	0
	Paper width 58 mm	1	01	1
1	Resolution : 180dpi	0	00	0
	Resolution : 203dpi	1	02	2
2 ~ 5	Reserved	-	-	-
6	Fixed	1	40	64
7	Fixed	0	00	0

## TM-P60

### Peeler models

**Model ID (when n = 1, 49 is specified)**

- **Hexadecimal = 69H / Decimal = 105**

**Type ID (when n = 2, 50 is specified)**

- **Bit 1: Always transmits [No autocutter].**
- **Bit 2: Always transmits [No DM-D (customer display) connection].**



# CONFIDENTIAL

## Type information (when n = 33 is specified)

The type information of this printer consists of the first to third 3 bytes.

- **First byte - bit 1:** Always transmits [No autocutter].
- **First byte - bit 2:** Always transmits [No DM-D (customer display) connection].
- **Second byte:** Always transmits [Hexadecimal = 40H / Decimal = 64].
- **Third byte - bit 0:** Always transmits [Peeler mechanism].

## Model name (when n = 67 is specified)

- The model name is [TM-P60].

## Model specific printer information A (when n = 96 is specified)

- Transmits a 3-byte data block comprised of [Header + DIP switch information (1 byte) + NUL].

Bit	Function	Binary	Hex	Decimal
0	(Reserved)	-	-	-
1	DIP switch [SW1-2] is OFF	0	00	0
	DIP switch [SW1-2] is ON	1	02	2
2,3	(Reserved)	-	-	-
4	DIP switch [SW2] is OFF	0	00	0
	DIP switch [SW2] is ON	1	10	16
5	(Reserved)	-	-	-
6	Fixed	1	40	64
7	Fixed	0	00	0

## TM-P60 models without Peeler

<sup>2</sup> **Printer model ID (n = 1, 49)**

Hex = 4AH / Decimal = 74

<sup>2</sup> **Type ID (n = 2, 50)**

# CONFIDENTIAL

**Bit 1: [Autocutter installed] is always transmitted.**

**Bit 2: [DM-D (Customer display) not connected] is always transmitted.**

**2 Type information (n = 33)**

**Type information of this printer consists of 2 bytes of [First byte] and [Second byte].**

**Bit 1 of the first byte: [Autocutter installed] is always transmitted.**

**Bit 2 of the first byte: [DM-D (Customer display) not connected] is always transmitted.**

**2 Printer model (n = 67)**

**Printer model: **TM-P60****

**2 Model dependent printer information A (n = 96):**

**Sends 3 byte data group composed of [header + DIP switches information (1 byte) + NUL].**

Bit	Binary	Hex	Decimal	Function
0	-	-	-	Reserved
1	0	00	0	DIP switch 1-2 OFF
	1	02	2	DIP switch 1-2 ON
2, 3	-	-	-	Reserved
4	0	00	0	DIP switch 1-2 OFF
	1	10	16	DIP switch 1-2 ON
5	-	-	-	Reserved
6	1	40	64	Fixed
7	0	00	0	Fixed

## TM-U230

- Printer model ID (n = 1, 49)

Hex = 2AH / Decimal = 42

- Type ID (n = 2, 50)

Bit 1: The bit always indicates Autocutter is installed.

Bit 2: The bit [DM-D (Customer display) isn't supported].

- Printer model (n = 67)

Printer model: **TM-U230**

## TM-U220

- Printer model ID (n = 1, 49)

Hex = 0DH / Decimal = 13

- Type ID (n = 2, 50)

Bit 1: [Autocutter is installed/not installed] indicates the state of DIP switch 2-2.

Bit 2: The bit [DM-D (Customer display) isn't supported].

- Printer model (n = 67)

Printer model: **TM-U220**

- Model dependent printer information (n = 112) send status of DIP switch as follows.

Send data is 4 bytes data group composed of [header + printer information (2 bytes) + NUL].

- Type information (n = 33)

Type information consists of 1 byte of [First byte].

Bit 1: [Autocutter is installed/not installed] indicates the state of DIP switch 2-2.

Bit 2: The bit [DM-D (Customer display) isn't supported].

- Font of Language for each country (n = 69)

Simplified Chinese model send the state of Memory switch [MSW 2-3].

[Name]	Set horizontal and vertical motion units
[Format]	ASCII      GS P <b>x y</b> Hex        1D 50 <b>x y</b> Decimal   29 80 <b>x y</b>
[Range]	$0 \leq x \leq 255$ $0 \leq y \leq 255$
[Default]	<b>TM-J2000/J2100, TM-T88IV: x = 180, y = 360</b> <b>TM-T90:    x = 180, y = 360 [Other than Japanese model]</b> <b>              x = 203, y = 406 [Japanese model]</b> <b>TM-T70:    x = 180, y = 180 [Other than Japanese model]</b> <b>              x = 203, y = 203 [Japanese model]</b> <b>TM-L90: x = 203, y = 406</b>
[Printers not featuring this command]	<b>TM-P60, TM-U230, TM-U220</b>
[Description]	Sets the horizontal and vertical motion units to approximately 25.4/ <b>x</b> mm {1/ <b>x</b> " } and approximately 25.4/ <b>y</b> mm {1/ <b>y</b> "}, respectively. <ul style="list-style-type: none"> <li>• When <b>x</b> = 0, the default value of the horizontal motion unit is used.</li> <li>• When <b>y</b> = 0, the default value of the vertical motion unit is used.</li> </ul>
[Notes]	<ul style="list-style-type: none"> <li>■ The horizontal direction is perpendicular to the paper feed direction and the vertical direction is the paper feed direction.</li> <li>■ The horizontal and vertical motion units indicate the minimum pitch used for calculating the values of related commands (shown on the next screen).</li> <li>■ In standard mode, the following commands use <b>x</b> or <b>y</b>.               <ul style="list-style-type: none"> <li>• Commands using <b>x</b>: <b>ESC SP, ESC \$, ESC \, GS ( P, GS L, and GS W</b></li> <li>• Commands using <b>y</b>: <b>ESC 3, ESC J, ESC K, GS ( P and GS V</b></li> </ul> </li> <li>■ In page mode, the following commands use <b>x</b> or <b>y</b>, when the starting position is set to the upper left or lower right of the print area using <b>ESC T</b>.</li> </ul>

# CONFIDENTIAL

- Commands using **x**: **ESC SP, ESC \$, ESC W, ESC \ GS ( O and FS S.**
- Commands using **y**: **ESC 3, ESC J, ESC K, ESC W, GS \$, GS V, GS ( O and GS \**
- In page mode, the following commands use **x** or **y**, when the starting position is set to the upper right or lower left of the print area using **ESC T.**
  - Commands using **x**: **ESC 3, ESC J, ESC K, ESC W, GS \$, GS ( O and GS \**
  - Commands using **y**: **ESC SP, ESC \$, ESC W, ESC \, FS S, GS ( O and GS V**
- Setting of this command is effective until **ESC @** is executed, the printer is reset, or the power is turned off.
- The calculated result from combining this command with others is truncated to the minimum value of the mechanical pitch.
- This command does not affect the current setting values.

[Model-dependent variations]

**TM-J2000/J2100, TM-T90, TM-T88IV, TM-L90, TM-T70**

## Program Example for all printers

```
PRINT #1, CHR$( &H1D); "P";CHR$(180);CHR$(180);
PRINT #1, CHR$( &H1B);"3";CHR$(30); ←Set line spacing
PRINT #1, "AAAAA"; CHR$( &HA);
PRINT #1, "BBBBB"; CHR$( &HA);
PRINT #1, CHR$( &H1D); "P";CHR$(180);CHR$(90);
PRINT #1, CHR$( &H1B);"3";CHR$(30); ←Set line spacing
PRINT #1, "CCCCC"; CHR$( &HA);
PRINT #1, "DDDDD"; CHR$( &HA);
PRINT #1, "EEEEEE"; CHR$( &HA);
```

## Print Sample

```
AAAAA
BBBBB
CCCCC
DDDDD
EEEEEE
```

30/180-inch line spacing

30/90-inch line spacing

**TM-J2000/J2100, TM-T90, TM-T88IV, TM-L90**

The default values equal one dot pitch horizontally and 1/2 dot pitch vertically.

**TM-T70**

The default value corresponds to the 1 dot pitch for both horizontal/vertical.

## GS g 0

[Name] Initialize maintenance counter

[Format] ASCII GS g 0 **m nL nH**  
 Hex 1D 67 30 **00 nL nH**  
 Decimal 29 103 48 **0 nL nH**

[Printers not featuring this command] **TM-U230, TM-U220**

[Range] **m = 0**  
**TM-J2100:  $30 \leq (nL + nH \times 256) \leq 34, (nL + nH \times 256) = 50, 70$**   
**TM-J2000:  $(nL + nH \times 256) = 30, 31, 33, 34, 50, 70$**   
**TM-T90, TM-T88IV, TM-T70, TM-P60:  $(nL + nH \times 256) = 20, 21, 50, 70$**   
**TM-L90:  $(nL + nH \times 256) = 20, 21, 70$  [TM-L90 with Peeler]**  
**TM-L90:  $(nL + nH \times 256) = 20, 21, 50, 70$  [TM-L90 models without Peeler]**

[Description] Sets the resettable maintenance counter specified by  $(nL + nH \times 256)$  to 0.

$(nL + nH \times 256)$	Counter
10 ~ 19	Serial impact head
20 ~ 29	Thermal head
30 ~ 39	Ink jet head
40 ~ 49	Shuttle head
50 ~ 59	Devices that conform to the normal specification
60 ~ 69	Optional devices
70 ~ 79	Time

- [Notes]
- In standard mode, this command is effective only when processed in the beginning of a line.
  - Unsupported counter numbers cannot be specified.
  - Do not use this command while a macro is being defined, because the command cannot be included in the macro.

- There are two types of maintenance counters: resettable counters and accumulation counters. A resettable counter is a maintenance counter that can be initialized, and an accumulation counter indicates the counter value from when the printer starts operation. An accumulation counter cannot be initialized (see **GS g 2** for details of the accumulation counter.)
- Featuring counters differ, depending on the printer model. See **GS g 2** for details.
- Take the following into account when writing data to a non-volatile memory.
  - Do not turn off the power or reset the printer from the interface when this command is being executed.
  - The printer may be in BUSY state when processing this command. In this case, be sure not to send a command from the host to the printer, because the printer will not receive the command.
  - Excessive use of this function may destroy the non-volatile memory. As a guideline, do not use any combination of the following commands more than 10 times per day for writing data to the non-volatile memory: **GS ( A** (part of functions), **GS ( C** (part of functions), **GS ( E** (part of functions), **GS ( L / GS 8 L** (part of functions), **GS ( M** (part of functions), **GS g 0**, **FS g 1**, **FS q**.
- The maintenance counter value can be transmitted by **GS g 2**.
- Note the rules below for the operating NV memory (store data / cancel data):
  - Even if the FEED button is pressed, the printer does not feed paper.
  - The printer does not process real-time commands.
  - Even if "ASB is enabled" is specified, the printer does not send ASB status.
- The maintenance counter value can be used for establishing the time for replacing consumed parts or cleaning.
- Types of counters differ, depending on the printer models (see the model-dependent information of **GS g 2**).

[Model-dependent variations] None

### Program Example

```
PRINT #1, CHR$( &H1D ); "g0"; CHR$( 0 ); CHR$( 11 ); CHR$( 0 ); ← Initializes print character counter
```

## GS g 2

[Name] Transmit maintenance counter

[Format] ASCII GS g 2 **m nL nH**  
 Hex 1D 67 32 00 **nL nH**  
 Decimal 29 103 50 0 **nL nH**

[Printers not featuring this command] **TM-U230, TM-U220**

[Range] **m = 0**

**TM-J2100 (two-color):**  $30 \leq (nL + nH \times 256) \leq 34$ ,  $(nL + nH \times 256) = 50, 70$   
 $158 \leq (nL + nH \times 256) \leq 162$ ,  $(nL + nH \times 256) = 178, 198$

**TM-J2000 (single-color):**  $(nL + nH \times 256) = 30, 31, 33, 34, 50, 70$   
 $(nL + nH \times 256) = 158, 159, 161, 162, 178, 198$

**TM-T90, TM-T88IV, TM-T70, TM-P60:**  $(nL + nH \times 256) = 20, 21, 50, 70$   
 $(nL + nH \times 256) = 148, 149, 178, 19$

**TM-L90:**  $(nL + nH \times 256) = 20, 21, 70$  [TM-L90 with Peeler]  
 $(nL + nH \times 256) = 148, 149, 198$   
 $(nL + nH \times 256) = 20, 21, 50, 70$  [TM-L90 models without Peeler]  
 $(nL + nH \times 256) = 148, 149, 178, 198$

[Description] Transmits the value of the maintenance counter specified by the number.

$(nL + nH \times 256)$	Type	Maintenance counter
10~19	Resettable	Serial impact head
20~29	Resettable	Thermal head
30~39	Resettable	Ink jet head
40~49	Resettable	Shuttle head
50~59	Resettable	Devices that conform to the normal specification
60~69	Resettable	Option devices
70~79	Resettable	Time
138~147	Accumulation	Serial impact head
148~157	Accumulation	Thermal head



( <b>nL</b> + <b>nH</b> × 256)	Type	Maintenance counter
158~167	Accumulation	Ink jet head
168~177	Accumulation	Shuttle head
178~187	Accumulation	Devices that conform to the normal specification
188~197	Accumulation	Option devices
198~207	Accumulation	Time

[Notes]

- There are two types of maintenance counters: resettable counters and accumulation counters. A resettable counter is a maintenance counter that can be initialized by **GS g 0**, and an accumulation counter indicates the counter value from when the printer starts operation.
- When a counter reaches its maximum value, its value is reset to 0 in the next updating process. Units and maximum values of counters differ, depending on the printer model and function. See the model-dependent variations for details.
- Unsupported counter numbers cannot be specified.
- This command transmits [Header ~ NUL], as shown below:

Transmitted data	Hex	Decimal	Amount of data
Header	5FH	95	1 byte
Counter value (*1)	30H ~ 39H	48 ~ 57	1 ~ 10 byte
NUL	00H	0	1 byte

- (\*1) When the counter values are transmitted, the printer converts them to character codes corresponding to the decimal value and transmits from the most significant bit.

Example: When the counter value is 120, the "120" (expressed hexadecimally as 31H, 32H, 30H. Decimally as 49, 50, and 48) is converted to 3 bytes of data.

- The resettable maintenance counter can be initialized by **GS g 0**.
- The maintenance counters built in the printer are standard; therefore, their values will be different, depending on the timing of occurring errors or turning off the power.
- The maintenance counter can be used for establishing the time for replacing consumed parts or cleaning.

- When you use this command, follow these rules.
  - When the host PC transmits the function data, transmit the next data after receiving the corresponding data (the header ~ NULL) from the printer.
  - With serial interface printers, be sure to use this function when the host is in the READY state.
  - With a parallel interface, the data sent by this function [Header ~ NUL], as with other data, is first stored in the send buffer, then output in sequential order when the host computer changes to the reverse mode. Note that the send buffer capacity is 99 bytes, and any data exceeding this volume limit will be lost; therefore, when using this command, it is important to configure the operation so that the host computer's change to the reverse mode and the subsequent status send/receive process is performed quickly.
- Types of maintenance counters differ, depending on the printer models.
- When the host is communicating with the printer by XON/XOFF control, the XOFF code might interrupt [Header ~ NUL].
- The maintenance counter data can be identified to other transmission data according to specific data of the transmission data block. When the header transmitted by the header is [hex = 5FH/decimal = 95], treat NUL [hex = 00H/decimal =0] as a data group and identify it according to the header.

[Model-dependent variations]

**TM-J2000/J2100, TM-T90, TM-T88IV, TM-T70, TM-L90, TM-P60**

## Program Example

```
PRINT #1, CHR$(&H1D); "g2"; CHR$(0); CHR$(11); CHR$(0); ← Transmit a counter value of print characters
```

# CONFIDENTIAL

## TM-J2000/J2100

The units and maximum values of the counters are as follows:

Number	Counter	Counting method	Unit	Maximum value
30,158	The number of paper feed lines	Counts a paper feed of 30 dots as one line (+1)	Lines	71,582,788
31,159	The average number of head strokes (1st color)	Counts a head driving stroke in 64-stroke unit (+1)	Strokes	4,294,967,295
32,160	The average number of head strokes (2nd color)	Counts a head driving stroke in 64-stroke unit (+1)	Strokes	4,294,967,295
33,161	The number of times of carriage driving	Counts the number of carriage passes when printing (+1)	Times	4,294,967,295
34,162	The number of pumping	Counts the number of pumping (+1)	Times	4,294,967,295
50,178	The number of autocutter operations	Counts an autocutter operation (+1)	Times	4,294,967,295
70,198	Period of printer operation	Counts the number of hours power has been on	Hours	71,582,788

Note: Commas used in the maximum values in the table above are not included in the transmission data.

## TM-T90, TM-T88IV, TM-T70, TM-L90, TM-P60

The units and maximum values of the counters are as follows:

Number	Counter	Counting method	Unit	Maximum value
20,148	The number of paper feed lines	Counts a paper feed 30 dots as one line (+1)	Lines	143,165,576

# CONFIDENTIAL

<b>Number</b>	<b>Counter</b>	<b>Counting method</b>	<b>Unit</b>	<b>Maximum value</b>
<b>21,149</b>	<b>The number of head energizing strokes</b>	<b>Counts a head energizing stroke of the thermal head (+1)</b>	<b>Times</b>	<b>4,294,967,295</b>
<b>50,178</b>	<b>The number of autocutter operations</b>	<b>Counts an autocutter operation (+1)</b>	<b>Times</b>	<b>4,294,967,295</b>
<b>70,198</b>	<b>Period of printer operation</b>	<b>Counts the number of hours the power has been on (except in the power save mode)</b>	<b>Hours</b>	<b>71,582,788</b>

**Note: Commas used in the maximum values in the table above are not included in the transmission data.**

## GS z 0

[Name]	Set online recovery wait time
[Format]	ASCII    GS z 0 <b>t1 t2</b> Hex        1D 7A 30 <b>t1 t2</b> Decimal    29 122 48 <b>t1 t2</b>
[Range]	$0 \leq \mathbf{t1} \leq 255$ $0 \leq \mathbf{t2} \leq 255$
[Default]	<b>t1</b> = 6, <b>t2</b> = 0
[Printers not featuring this command]	<b>TM-J2000/J2100</b> , <b>TM-T90</b> , <b>TM-T88IV</b> , <b>TM-T70</b> , <b>TM-L90</b> , <b>TM-P60</b> , <b>TM-U220</b>
[Description]	<p>Sets the online recovery wait time from the time a new roll paper is installed to when the printer goes online.</p> <ul style="list-style-type: none"> <li>• This command sets the paper wait time to (<b>t1</b> × 500 msec). When <b>t1</b> = 0, the paper wait time is set to 0.</li> <li>• This command sets the recovery confirmation time to (<b>t2</b> × 500 msec). When <b>t2</b> = 0, the recovery confirmation time is canceled.</li> </ul>
[Notes]	<ul style="list-style-type: none"> <li>■ The printer is in the paper wait time status after loading the paper. During this time, the printer performs the following:               <ul style="list-style-type: none"> <li>• The paper out LED is off.</li> <li>• Paper can be fed by pressing the paper feed button.</li> <li>• The printer is in the recovery confirmation time after the paper wait time (<b>t1</b> × 500 msec) has elapsed.</li> <li>• The printer can be set online by <b>DLE ENQ (n = 0)</b>.</li> </ul> </li> <li>■ When the paper wait time is set to 0 (<b>t1</b> = 0), the printer is in the recovery confirmation status immediately after the paper loading.</li> <li>■ In the recovery confirmation status, the printer performs the following:               <ul style="list-style-type: none"> <li>• The paper out LED blinks.</li> <li>• The printer recovers online by pressing the paper feed button. Paper cannot be fed by pressing the paper feed button.</li> <li>• The printer recovers online after the recovery confirmation time (<b>t2</b> × 500 msec) has elapsed.</li> </ul> </li> </ul>

- The printer can be set online by **DLE ENQ (n = 0)**.
- During recovery confirmation time, the paper cannot be fed by pressing the paper feed button.
- When the recovery confirmation time is canceled (**t2 = 0**), the printer recovers online by executing **DLE ENQ (n = 0)** or pressing the paper feed button.
- During the paper wait time and recovery confirmation time, if a paper-end is detected, the printer restarts processing from loading a roll paper.
- When the panel buttons are disabled by **ESC c 5**, the paper feed button can be used temporarily during the paper wait time and recovery confirmation time.
- The paper out LED is off when the printer recovers online.
- Online recovery wait time status is checked by **DLE EOT (n=1: Printer status)**.
- The paper out LED and paper feed button are different, depending on the printer model.

■ The procedures for online recovery by pressing the paper feed button are as follows:

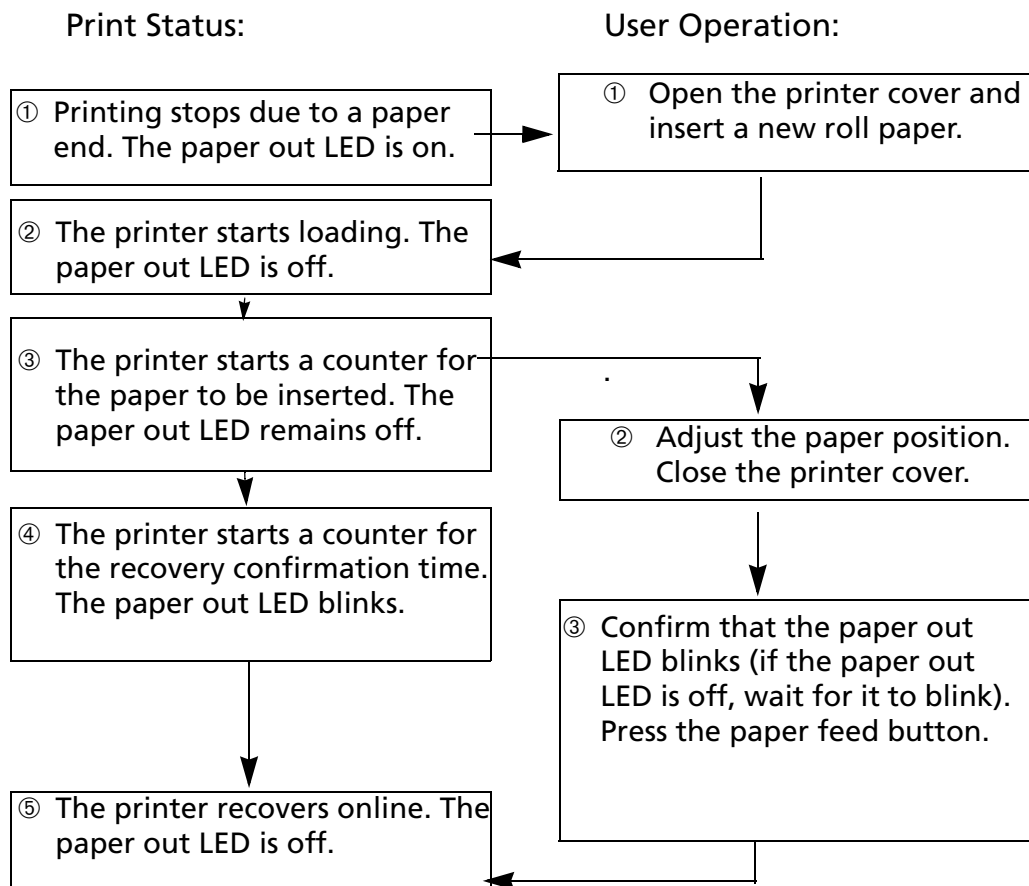

## Print status

Status ①:

Normal operation → Not printing because of a paper-end

The printer stops printing and goes offline when the roll paper sensor detects a paper-end. The paper out LED is on.

# CONFIDENTIAL

Printer status ②: Not printing because of a paper-end

When the sensor detects that a roll paper is inserted, the printer starts loading.

Printer status ③: Waiting for a roll paper to be inserted (waiting for online recovery)

The printer is in the paper wait status after loading and the paper out LED is off.

Printer status ④: Recovery confirmation status (online recovery wait status)

After waiting for a roll paper to be inserted, the paper out LED blinks, and the printer is in the recovery confirmation status.

Printer status ⑤: Normal operation

When the online recovery wait time (the printer status ③ + ④) has elapsed, when the paper feed button is pressed during the recovery confirmation time, or when **DLE ENQ (n = 0)** is executed, the paper out LED is off, the printer recovers online, and the printer executes normal processing.

During printer status ③ and ④, ASB status and **DLE EOT (n = 1: Printer status)** are "online recovery wait status."

## User Operation

Operation ①: When the printer stops printing because of a paper-end, open the printer cover, remove the old roll paper, and insert a new roll paper.

Operation ②: When paper position adjustment is needed, close the printer cover after the adjustment. If the paper out LED is off, the paper can be fed by the paper feed button. After completing paper insertion, be sure to close the printer cover.

Operation ③: Make sure that the paper out LED is blinking. If the paper out LED is off, wait until it blinks. After confirming that the paper out LED is blinking, press the paper feed button.

[Model-dependent variations]

**TM-U230**

### Program Example for all printers

```
PRINT #1, CHR$( &h1D ); "z0"; CHR$( 10 ); CHR$( 60) ← Transmits Waiting for a roll paper to be inserted in  
5 sec, Recovery confirmation status in 30 sec.
```



# C O N F I D E N T I A L

## **TM-U230**

**When waiting for a roll paper to be inserted status, the paper out LED is off. When the printer is in the recovery confirmation status, the paper out LED is blinks. The paper feed switch is FEED.**

## GS z 0 (TM-L90 w/ Peeler)

SETTING COMMAND

[Name]	Set online recovery wait time
[Format]	ASCII      GS z 0 <b>t1 t2</b> Hex        1D 7A 30 <b>t1 t2</b> Decimal    29 122 48 <b>t1 t2</b>
[Range]	<b>t1</b> = 0, 0 ≤ <b>t2</b> ≤ 255
[Default]	<b>t1</b> = 0, <b>t2</b> = 0
[Description]	When the peeling issuing mode is selected, sets the online recovery wait time, the wait time for the FEED button to be pressed when the printer goes online (recovery confirmation time), to ( <b>t2</b> × 500 msec). When <b>t2</b> = 0, the recovery confirmation time is canceled.
[Notes]	<ul style="list-style-type: none"> <li>■ when the peeling issuing mode is selected, the settings of this command affect the online recovery wait status described below. The peeling issuing mode and the continuous issuing mode can be selected by a switch. This is a slide switch that can be used when the roll paper cover is open:               <ul style="list-style-type: none"> <li>• Waiting for the FEED button to be pressed after closing the roll paper cover.</li> <li>• Waiting for the FEED button to be pressed after removing a label (when the peeling detector cannot detect a label due to sunlight.)</li> </ul> </li> <li>■ After the paper roll cover is closed, in the online recovery wait status, the printer executes the following:               <ul style="list-style-type: none"> <li>• Flashes the PAPER OUT LED and feeds the paper to the peeling position.</li> <li>• In the online recovery wait status, the printer recovers by any of the following and the paper is fed to the print starting position:                    The FEED button is pressed.                    The recovery confirmation time (<b>t2</b> × 500 msec) has elapsed.  <b>DLE ENQ (n = 0)</b> is executed</li> </ul> </li> <li>■ In the online recovery wait time when a label is removed, the printer executes the following:               <ul style="list-style-type: none"> <li>• Flashes the PAPER OUT LED for removing the label (Example: Execution of Function 65 of <b>FS ( L)</b>)</li> <li>• Operators need to remove the label. If the PAPER OUT LED still flashes after the label is removed, the printer is in the wait status for the FEED button to be pressed.</li> </ul> </li> </ul>

- In the online recovery wait status, the printer recovers by any of the following and the paper is fed to the print starting position:
  - The FEED button is pressed.
  - The recovery confirmation time ( $t_2 \times 500$  msec) has elapsed.
  - DLE ENQ (n = 0)** is executed
- During the online recovery time, the paper cannot be fed by pressing the paper feed button.
- When the online recovery time is canceled ( $t_2 = 0$ ), the printer recovers online by executing **DLE ENQ (n = 0)** or pressing the paper feed button.
- When the panel buttons are disabled by **ESC c 5**, the paper feed button can be used temporarily during the online recovery wait time.
- The PAPER OUT LED is off when the printer recovers online.
- Online recovery wait time status is checked by the ASB status or **DLE EOT (n = 1: Printer status)**.
- The procedures for online recovery from when the roll paper cover is closed to when the PAPER FEED button is pressed is as follows:

### Print Status:

- |   |
|---|
| ① The printer feeds paper to the peeling position. The PAPER OUT LED flashes. |
| ② The printer recovers online. The PAPER OUT LED is off.                      |

### User Operation:

- |   |
|---|
| ① Insert roll paper and close the cover.  |
| ② Insert paper through the peeler. Close the peeler cover. Press the FEED button. |

- Supplement print status
- Status ①: The printer feeds paper in paper feed direction.
- Printer status ②: The printer feeds the paper in either paper feed direction or in the reverse direction.

- The printer automatically in the status of not waiting for the label to be removed when an operator removes the label at the peeling position. If the printer is in an area where the label peeling detector cannot detect paper due to direct sunlight, the operator needs to press the FEED button once after removing the label. Installing the printer in a place with no direct sunlight is recommended.

### Program Example for all printers

```
PRINT #1, CHR$(&h1D);"z0";CHR$(0);CHR$(60) ← Sets the online recovery wait time to 30 sec.
```

## KANJI COMMANDS

Command	Name
---------	------

<b>FS !</b>	Select print mode(s) for Kanji characters
<b>FS &amp;</b>	Select Kanji character mode
<b>FS ( A</b>	Select Kanji character style(s)
	Select Kanji character font
<b>FS -</b>	Turn underline mode on/off for Kanji characters
<b>FS .</b>	Cancel Kanji character mode
<b>FS 2</b>	Define user-defined Kanji characters
<b>FS C</b>	Select Kanji character code system
<b>FS S</b>	Set Kanji character spacing
<b>FS W</b>	Turn quadruple-size mode on/off for Kanji characters
<b>FS ?</b>	Cancel user-defined Kanji characters

## FS !

[Name] Select print mode(s) for Kanji characters

[Format] ASCII FS ! **n**  
 Hex 1C 21 **n**  
 Decimal 28 33 **n**

[Printers not featuring this command] None

[Range]  $0 \leq n \leq 255$

[Default] **n** = 0

[Description] Selects the character styles (double-height, double-width, and Kanji-underlined) together for multi-byte code character as follows:

<b>n: Bit</b>	<b>Function</b>	<b>Binary</b>	<b>Hexadecimal</b>	<b>Decimal</b>
0	Reserved	Off	00	0
1	Reserved	Off	00	0
2	Double-width canceled	Off	00	0
	Double-width selected	On	04	4
3	Double-height canceled	Off	00	0
	Double-height selected	On	08	8
4~6	Reserved	Off	00	0
7	Kanji underline mode is turned off	Off	00	0
	Kanji underline mode is turned on	On	80	128

[Notes]

- Settings of this command affect multilingual characters and user-defined characters.
- Settings of this command are effective until any of the following commands are executed, **ESC @** is executed, the printer is, or the power is turned off.
  - Character size (bits 2 and 3): **FS W, GS !**
  - Underline (bit 7): **FS -**
- When a double-height mode is specified, a character is enlarged based on a baseline of the character.
- When a double-width mode is specified, a character is enlarged based on the left side of the character.
- When both double-width and double-height modes are specified, quadruple-size characters are printed.
- When double-height mode is selected in standard mode, a character is enlarged in the paper feed direction and when double-width mode is selected, a character is enlarged in the direction which is perpendicular to the paper feed direction. Therefore, when 90° clockwise-rotation is selected, the relationship between directions of enlargement of double-height and double-width is opposite from normal direction.
- When double-height mode is selected in page mode, height size is enlarged and when double-width mode is selected in page mode, width size is enlarged.
- When Kanji underline mode is specified, the width of the underline set by **FS -** is added. Even if the character size is changed, the width is not changed. The underline has the same color as the characters. The color can be selected by Function 48 of **GS ( N**.
- Even if Kanji underline mode is specified, 90° clockwise-rotated characters, white/black reverse characters, and spaces skipped by **HT, ESC \$**, or **ESC \** are not underlined.

## Program Example

```
PRINT #1, CHR$(&H1C);"C";CHR$(0);  
PRINT #1, CHR$(&H1C);"&";  
PRINT #1, CHR$(&H1C);"!";CHR$(0);  
PRINT #1, CHR$(&H24);CHR$(&H22);CHR$(&H24);CHR$(&H22);  
PRINT #1, CHR$(&H1C);"!";CHR$(4);  
PRINT #1, CHR$(&H24);CHR$(&H24);CHR$(&H24);CHR$(&H24);  
PRINT #1, CHR$(&H1C);"!";CHR$(8);  
PRINT #1, CHR$(&H24);CHR$(&H26);CHR$(&H24);CHR$(&H26);  
PRINT #1, CHR$(&H1C);"!";CHR$(12);  
PRINT #1, CHR$(&H24);CHR$(&H28);CHR$(&H24);CHR$(&H28);  
PRINT #1, CHR$(&HA);  
PRINT #1, CHR$(&H1C);".";
```

← Select JIS code system

← Specify Kanji mode

← Cancel Kanji mode

## Print Sample

ああいううええ

ああ：装飾なし  
いい：倍幅拡大  
うう：縦倍拡大  
ええ：倍幅拡大+縦倍拡大



## FS &

[Name] Select Kanji character mode

[Format] ASCII FS &  
Hex 1C 26  
Decimal 28 38

[Printers not featuring this command] None

[Description] Selects Kanji character mode.

- [Notes]
- This command can be used only for the Japanese, Simplified Chinese, and Traditional Chinese models.
  - Settings of this command are effective until **FS .** is executed, **ESC @** is executed, the printer is reset, or the power is turned off.
  - Notes for Japanese model:
    - Settings of this command affect processing of a character code only when JIS code system is selected by **FS C**.
    - If Kanji mode is specified when JIS code system is selected, the printer processes a character code as a 2-byte code.
    - Kanji codes are processed in order of the first byte then the second byte.
    - Kanji mode is canceled at default.
  - Notes for Simplified Chinese model:
    - When Kanji mode is selected, the printer processes a character code that corresponds to the first byte of Kanji code, and then processes consecutive byte(s) as the second byte ( ~ the fourth byte) of Kanji code. Therefore, when Kanji code is specified, an ASCII code character that corresponds to the first byte of Kanji code cannot be printed.
    - Kanji mode is selected at default.

## ■ Notes for Traditional Chinese model:

- When Kanji mode is selected, the printer processes a character code that corresponds to the first byte of Kanji code, and then processes a consecutive byte as the second byte of Kanji code. Therefore, when Kanji code is specified, an ASCII code character that corresponds to the first byte of Kanji code cannot be printed.
- Kanji mode is selected at default.

### Program Example

```
PRINT #1, CHR$(&H1C);"C";CHR$(0);           ← Select JIS code system
PRINT #1, CHR$(&H1C);"&";                   ← Specify Kanji mode
PRINT #1, CHR$(&H34);CHR$(&H41);
PRINT #1, CHR$(&H3B);CHR$(&H7A); CHR$(&HA);
```

### Print Sample

漢字

[Name] Select Kanji character style(s)

[Printers not featuring this command] **TM-T88IV**, **TM-U230**, **TM-U220**

[Description] Selects the multi-byte code character style.

- Function code **fn** specifies the function.

fn	Function No.	Function name
48	<b>Function 48</b>	Select Kanji character font

- pl**, **ph** specifies (**pl** + **ph** × 256) as the number of bytes after **ph** (**fn** and **[parameters]**). The **[parameters]** are described in each function.

- [Notes]
- This command is specified function by function code (**fn**). Operation details are different depending on function.
  - Settings of this command affect multilingual characters and user-defined characters.
  - Settings of this command are effective until it is redefined, **ESC @** is executed, the printer is reset, or the power is turned off.

### Program Example

```
PRINT #1, CHR$( &h1C ); "C"; CHR$( 0 );           ←Select JIS code system
PRINT #1, CHR$( &h1C ); "&";
PRINT #1, CHR$( &h1C ); " (A"; CHR$( 2 ); CHR$( 0 ); CHR$( 48 ); CHR$( 48 ); ←<Function 48>
PRINT #1, CHR$( &h34 ); CHR$( &h41 ); CHR$( &h3B ); CHR$( &h7A ); CHR$( &hA );
PRINT #1, CHR$( &h1C ); " (A"; CHR$( 2 ); CHR$( 0 ); CHR$( 48 ); CHR$( 50 ); ←<Function 48>
PRINT #1, CHR$( &h34 ); CHR$( &h41 ); CHR$( &h3B ); CHR$( &h7A ); CHR$( &hA );
PRINT #1, CHR$( &h1C ); ". ";
```

### Print Sample

漢字  
漢字

## FS ( A **pL pH fn m** <Function 48>

---

[Name] Select Kanji character font

[Format] ASCII FS ( A **pL pH fn m**  
 Hex 1D 28 41 02 00 30 **m**  
 Decimal 28 40 65 2 0 48 **m**

[Range] (**pL** + **pH** × 256) = 2 (**pL** = 2, **pH** = 0)  
**fn** = 48

**TM-J2000/J2100, TM-T90, TM-L90, TM-P60: 0 ≤ m ≤ 2, 48 ≤ m ≤ 50**  
**TM-T70: m = 0, 1, 48, 49**

[Default] **TM-J2000/J2100, TM-T90, TM-T70, TM-L90: m = 0**  
**TM-P60: m = 1**

[Description] Selects multi-byte code character font (Kanji character font).

<b>m</b>	<b>fn</b>
0, 48	Select Kanji character Font A
1, 49	Select Kanji character Font B
2, 50	Select Kanji character Font C

[Notes] ■ Each Kanji character font configuration differs, depending on the model.

[Model-dependent variations] **TM-J2000/J2100, TM-T90, TM-L90, TM-P60, TM-T70**

**TM-J2000/J2100, TM-T90, TM-L90, TM-P60**

**This function is only for the Japanese model. Character configuration of each Kanji font is as follows:**

**Kanji Font A (24 × 24)**

**Kanji Font B (20 × 24)**

**Kanji Font C (16 × 16)**

# CONFIDENTIAL

## TM-T70

This function is only for the Japanese model. Character configuration of each Kanji font is as follows:

**Kanji Font A (24 × 24)**

**Kanji Font B (16 × 16)**

## FS –

[Name] Turn underline mode on/off for Kanji characters

[Format] ASCII FS – **n**  
 Hex 1C 2D **n**  
 Decimal 28 45 **n**

[Printers not featuring this command] None

[Range] **TM-J2000/J2100, TM-T90, TM-T88IV, TM-T70, TM-L90, TM-P60: 0 ≤ n ≤ 2, 48 ≤ n ≤ 50**  
**TM-U230, TM-U220: n = 0, 1, 48, 49**

[Default] **n = 0**

[Description] Turns on or off underline mode for multi-byte code character (Kanji-underline), using **n** as follows:

<b>n</b>	<b>Function</b>
0, 48	Turns off Kanji-underline mode
1, 49	Turns on Kanji-underline mode (1-dot thick)
2, 50	Turns on Kanji-underline mode (2-dots thick)

- [Notes]
- Settings of this command affect multilingual characters and user-defined characters.
  - The underline has the same color as the characters. The color can be selected by Function 48 of **GS ( N**.
  - Even if Kanji underline mode is specified, 90° clockwise-rotation characters, white/black reverse characters, and spaces skipped by **HT**, **ESC \$**, or **ESC \** are not underlined.
  - When a character size is changed, an underline width is not changed.
  - When underline mode is canceled, the following characters are not underlined; however, an underline width set right before the mode is canceled remains.
  - Settings of this command are effective until **FS !** is executed, **ESC @** is executed, the printer is reset, or the power is turned off.
  - Some printer models support Kanji underline mode with 2-dot width.

## Program Example

```
PRINT #1, CHR$(&H1C); "C";CHR$(0);          ←Select JIS code system
PRINT #1, CHR$(&H1C); "&";
PRINT #1, CHR$(&H1C); "-" ;CHR$(1);          ←Select underline mode
PRINT #1, CHR$(&H34);CHR$(&H41);
PRINT #1, CHR$(&H3B);CHR$(&H7A);CHR$(&HA);
PRINT #1, CHR$(&H1C); "-" ;CHR$(0);          ←Cancel underline mode
PRINT #1, CHR$(&H34);CHR$(&H41);
PRINT #1, CHR$(&H3B);CHR$(&H7A);CHR$(&HA);
PRINT #1, CHR$(&H1C); ". ";                  ←Cancel Kanji mode
```

## Print Sample

```
漢字 ← 1-dot width underline added
漢字 ← No underline
```

## FS .

[Name] Cancel Kanji character mode

[Format] ASCII FS .  
Hex 1C 2E  
Decimal 28 46

[Printers not featuring this command] None

[Description] Cancels Kanji character mode.

- [Notes]
- This command can be used only for the Japanese, Simplified Chinese, and Traditional Chinese models.
  - Settings of this command are effective until **FS &** is executed, **ESC @** is executed, the printer is reset, or the power is turned off.
  - Notes for Japanese model:
    - Settings of this command affect character code processing only when JIS code system is selected by **FS C**.
    - When JIS code system is selected, if Kanji mode is canceled, the printer processes a character code as a 1-byte code of alphanumeric Katakana characters.
    - Kanji mode is canceled at default.
  - Notes for Simplified Chinese model:
    - If Kanji mode is canceled, the printer processes a character code as a 1-byte code of alphanumeric Katakana characters.
    - Kanji mode is selected at default.
  - Notes for Traditional Chinese model:
    - If Kanji mode is canceled, the printer processes a character code as a 1-byte code of alphanumeric Katakana characters.
    - Kanji mode is selected at default.



## Program Example

```
PRINT #1, CHR$(&H1C);"C";CHR$(0);           ← Select JIS code system
PRINT #1, CHR$(&H1C);"&";                   ← Specify Kanji mode
PRINT #1, CHR$(&H34);CHR$(&H41);
PRINT #1, CHR$(&H3B);CHR$(&H7A); CHR$(&HA);
PRINT #1, CHR$(&H1C);".";
PRINT #1, "kanji"; CHR$(&HA);               ← Cancel Kanji mode
```

## Print Sample

漢字  
kanji

## FS 2

[Name] Define user-defined Kanji characters

[Format] ASCII FS 2 **c1 c2 d1...dk**  
 Hex 1C 32 **c1 c2 d1...dk**  
 Decimal 28 50 **c1 c2 d1...dk**

[Printers not featuring this command] None

[Range] The ranges of **c1** and **c2** differ, depending on models and the character code system used. The ranges of **c1** and **c2** for each model are as follows.

Models	c1	c2
Japanese model (JIS code)	<b>c1</b> = 77H	21H ≤ <b>c2</b> ≤ 7EH
Japanese model (SHIFT JIS code)	<b>c1</b> = ECH	40H ≤ <b>c2</b> ≤ 7EH, 80H ≤ <b>c2</b> ≤ 9EH
Simplified Chinese	<b>c1</b> = FEH	A1H ≤ <b>c2</b> ≤ FEH
Traditional Chinese	<b>c1</b> = FEH	A1H ≤ <b>c2</b> ≤ FEH

0 ≤ **d** ≤ 255

**TM-J2000/J2100, TM-T90, TM-L90:**

**k = 72 [Simplified Chinese model / Traditional Chinese model]**

**k = 72 [Japanese model: Kanji Font A (24 × 24)]**

**k = 60 [Japanese model: Kanji Font B (20 × 24)]**

**k = 32 [Japanese model: Kanji Font C (16 × 16)]**

**TM-T88IV:**

**k = 72**

**TM-T70:**

**k = 72 [Kanji Font A (24 × 24)]**

**k = 60 [Kanji Font B (16 × 16)]**

**TM-P60:**

**k = 72 [Kanji Font A (24 × 24)]**

**k = 60 [Kanji Font B (20 × 24)]**

**k = 32 [Kanji Font C (16 × 16)**

**TM-U230, TM-U220:**

**k = 32**

[Description]

Defines the user-defined Kanji character pattern specified by the character codes (**c1** and **c2**) of the currently selected Kanji font.

- **c1** specifies the first byte of a character code for a user-defined Kanji character.
- **c2** specifies the second byte of a character code for a user-defined Kanji character.
- **d** specifies the defined data (column format).
- **k** indicates the number of defined data. **k** is an explanation parameter; therefore, it does not need to be transmitted.

[Notes]

- This command is effective only for the Japanese, Simplified Chinese, and Traditional Chinese models.
- The printer processes **k** byte data of **d1...dk** as defined data. The defined data (**d**) sets a corresponding bit to 1 to print a dot or to 0 not to print a dot.
- The number of characters to be defined differ, depending on the printer models.
- Different user-defined characters can be defined for each Kanji character. Kanji fonts can be specified by function 48 of **FS ( A**.
- Defined data is effective until it is redefined, **ESC @** is executed, the printer is reset, or the power is turned off.
- User-defined characters are not defined and space is printed at the default.
- The relationship between the defined data and a print result is as follows.  
Example: data of the definition of the user defined character (2 bytes in vertical × 16 dots in horizontal) is necessary. (**k = 32**)

<b>d1</b>	<b>d3</b>	<b>d5</b>	...	<b>d27</b>	<b>d29</b>	<b>d31</b>	MSB
							LSB
<b>d2</b>	<b>d4</b>	<b>d6</b>	...	<b>d28</b>	<b>d30</b>	<b>d32</b>	MSB
							LSB

[Model-dependent variations]

**TM-J2000/J2100, TM-T90, TM-T88IV, TM-T70, TM-L90, TM-P60, TM-U230, TM-U220**

Program Example	Print Sample
<pre> PRINT #1, CHR\$(&amp;H1C);"C"; CHR\$(0):           ←Select JIS code system PRINT #1, CHR\$(&amp;H1C);"2"; PRINT #1, CHR\$(&amp;H77);CHR\$(&amp;H21); FOR k = 1 To 32   READ d: PRINT #1, CHR\$(d); NEXT k PRINT #1, CHR\$(&amp;H1C);"&amp;";                     ←Specify Kanji mode PRINT #1, CHR\$(&amp;H77);CHR\$(&amp;H21); PRINT #1, CHR\$(&amp;H33);CHR\$(&amp;H30); PRINT #1, CHR\$(&amp;H3B);CHR\$(&amp;H7A);CHR\$(&amp;HA); PRINT #1, CHR\$(&amp;H3B);CHR\$(&amp;H7A);CHR\$(&amp;HA); PRINT #1, CHR\$(&amp;H1C);". ";                   ←Cancel Kanji mode  DATA &amp;H00, &amp;H00, &amp;H00, &amp;H00, &amp;H01, &amp;HE0, &amp;H07, &amp;HF0 DATA &amp;H0F, &amp;HF0, &amp;H1F, &amp;HF2, &amp;H3F, &amp;HE2, &amp;H7F, &amp;HFE DATA &amp;H7F, &amp;HFE, &amp;H3F, &amp;HE2, &amp;H1F, &amp;HF2, &amp;H0F, &amp;HF0 DATA &amp;H07, &amp;HF0, &amp;H01, &amp;HE0, &amp;H00, &amp;H00, &amp;H00, &amp;H00           </pre>	<p style="text-align: center;">♠ 外字</p>

## TM-J2000/J2100

It is possible to define 32 user-defined characters for each font. If 32 user-defined characters are already defined, defined character code can be redefined; however, user-defined characters cannot be defined to new character codes.

## TM-T90, TM-T88IV, TM-T70, TM-L90, TM-P60

The user-defined characters can be defined for all the character codes in a range.

## **TM-U230**

A user-defined character for one character can be defined.

If a user-defined character is already defined, defined character code can be redefined; however, user-defined characters cannot be defined to new character codes. Horizontal adjacent dots cannot be specified as print data.

## **TM-U220**

5 characters can be defined as external characters.

If 5 characters are already defined as external characters, although it is possible to redefine the defined character codes, it is not possible to define new character codes as external characters.

It is not possible to specify horizontally consecutive dots as print data for the external character definition pattern.

## FS C

[Name] Select Kanji character code system

[Format] ASCII FS C **n**  
 Hex 1C 43 **n**  
 Decimal 28 67 **n**

[Printers not featuring this command] None

[Range] **TM-J2000/J2100, TM-T90, TM-T88IV, TM-T70, TM-L90, TM-P60: n = 0, 1, 48, 49**  
**TM-U230, TM-U220: n = 0, 1**

[Default] **n = 0**

[Description] Selects a Kanji character code system for the Japanese model as follows:

<b>n</b>	<b>Kanji</b>
0, 48	JIS code
1, 49	SHIFT JIS code

- [Notes]
- This command is effective only with the Japanese Kanji models.
  - When JIS code system is selected, Kanji mode should be specified by **FS &** to print Kanji characters.
  - When SHIFT JIS code system is selected, if the printer processes a character code that corresponds to the first byte of the Kanji code, the printer processes a consecutive byte as the second byte of the Kanji code. Therefore, when this code system is selected, ASCII code that corresponds to the first byte of the Kanji code cannot be printed.
  - Kanji code processes the first byte and the second byte in order.
  - The command is effective until **ESC @** is executed, the printer is reset, or the power is turned off.

## Program Example

```
PRINT #1, CHR$(&H1C);"C";CHR$(0);           ← Select JIS code system
PRINT #1, CHR$(&H1C);"&";                     ← Specify Kanji mode
PRINT #1, CHR$(&H34);CHR$(&H41);
PRINT #1, CHR$(&H3B);CHR$(&H7A); CHR$(&HA);
PRINT #1, CHR$(&H1C);". ";                     ← Cancel Kanji mode

PRINT #1, CHR$(&H1C);"C";CHR$(1);             ← Select SHIFT JIS code system
PRINT #1, CHR$(&H8A);CHR$(&HBF);
PRINT #1, CHR$(&H8E);CHR$(&H9A); CHR$(&HA);
```

## Print Sample

```
漢字 ← Print using JIS code
漢字 ← Print using SHIFT JIS code
```

## FS S

[Name]	Set Kanji character spacing															
[Format]	<table border="0"> <tr> <td>ASCII</td> <td>FS</td> <td>S</td> <td><b>n1</b></td> <td><b>n2</b></td> </tr> <tr> <td>Hex</td> <td>1C</td> <td>53</td> <td><b>n1</b></td> <td><b>n2</b></td> </tr> <tr> <td>Decimal</td> <td>28</td> <td>83</td> <td><b>n1</b></td> <td><b>n2</b></td> </tr> </table>	ASCII	FS	S	<b>n1</b>	<b>n2</b>	Hex	1C	53	<b>n1</b>	<b>n2</b>	Decimal	28	83	<b>n1</b>	<b>n2</b>
ASCII	FS	S	<b>n1</b>	<b>n2</b>												
Hex	1C	53	<b>n1</b>	<b>n2</b>												
Decimal	28	83	<b>n1</b>	<b>n2</b>												
[Printers not featuring this command]	None															
[Range]	<b>TM-J2000/J2100, TM-T90, TM-T88IV, TM-T70, TM-L90, TM-P60: <math>0 \leq n1 \leq 255, 0 \leq n2 \leq 255</math></b> <b>TM-U230, TM-U220: <math>0 \leq n1 \leq 32, 0 \leq n2 \leq 32</math></b>															
[Default]	<b>TM-J2000/J2100, TM-T90, TM-T88IV, TM-T70, TM-L90, TM-P60: <math>n1 = 0, n2 = 0</math></b> <b>TM-U230, TM-U220: <math>n1 = 0, n2 = 0</math></b>															
[Description]	<p>Sets left- and right-side spacing of the multi-byte code character <b>n1</b> and <b>n2</b>, respectively.</p> <ul style="list-style-type: none"> <li>• Sets the left-side character spacing to [<b>n1</b> × horizontal or vertical motion units].</li> <li>• Sets the right-side character spacing to [<b>n2</b> × horizontal or vertical motion units].</li> </ul>															
[Notes]	<ul style="list-style-type: none"> <li>■ Settings of this command affect multilingual characters and user-defined characters.</li> <li>■ When a character size is set to N times as large as a normal size, both right- and left-side character spacings are also set to N times as large as a normal size.</li> <li>■ In standard mode, the horizontal motion unit (perpendicular to the paper feed direction) is used.</li> <li>■ In page mode, the horizontal or vertical motion unit differs, depending on the starting position set by <b>ESC T</b>. <ul style="list-style-type: none"> <li>• When the starting position is set to the upper left or lower right, the horizontal motion unit (perpendicular to the paper feed direction) is used.</li> <li>• When the starting position is set to the upper right or lower left, the vertical motion unit (paper feed direction) is used.</li> </ul> </li> <li>■ Different character spacing can be set for standard mode and page mode. <ul style="list-style-type: none"> <li>• When this command is set in standard mode, character spacing for multilingual (except Thai) characters printed in standard mode is set.</li> <li>• When this command is set in page mode, character spacing for multilingual (except Thai) characters printed in page mode is set.</li> </ul> </li> </ul>															



# CONFIDENTIAL

- If the horizontal or vertical motion unit is changed after setting the character spacing, the spacing between the characters is not changed.
- The character spacing is effective until **ESC @** is executed, the printer is reset, or the power is turned off.
- This command is used to change spacing between characters.

[Model-dependent variations]

**TM-J2000/J2100**, **TM-T90**, **TM-T88IV**, **TM-T70**, **TM-L90**, **TM-P60**, **TM-U230**,  
**TM-U220**

## Program Example

```
PRINT #1, CHR$( &H1D ); "P"; CHR$( 180 ); CHR$( 180 );
PRINT #1, CHR$( &H1C ); "C"; CHR$( 0 );           ←Select JIS code system
PRINT #1, CHR$( &H1C ); "&";                       ←Specify Kanji mode
PRINT #1, CHR$( &H1C ); "S"; CHR$( 0 ); CHR$( 0 );
PRINT #1, CHR$( &H34 ); CHR$( &H41 );
PRINT #1, CHR$( &H3B ); CHR$( &H7A ); CHR$( &HA );
PRINT #1, CHR$( &H1C ); "S"; CHR$( 8 ); CHR$( 8 );
PRINT #1, CHR$( &H34 ); CHR$( &H41 );
PRINT #1, CHR$( &H3B ); CHR$( &H7A ); CHR$( &HA );
PRINT #1, CHR$( &H1C ); ". ";                       ←Cancel Kanji mode
```

## Print Sample

漢字

漢 字

← Left- and right-side character spacing: 0 mm

← Left- and right-side character spacing: approx. 1.129 mm (8/180°)

**TM-J2000/J2100**, **TM-T90**, **TM-T88IV**, **TM-T70**, **TM-L90**

The horizontal and vertical motion units are set by **GS P**.

## TM-P60

The horizontal and vertical motion unit is about 0.125 mm {1/203 inch}. This corresponds to 1 dot pitch.

## TM-U230, TM-U220

The horizontal motion unit is approximately 0.159 mm {1/160 inch}. This is equivalent to a half dot pitch.

## FS W

[Name] Turn quadruple-size mode on/off for Kanji characters

[Format]      ASCII      FS   W   **n**  
                  Hex        1C   57   **n**  
                  Decimal   28   87   **n**

[Printers not featuring this command] None

[Range]         $0 \leq n \leq 255$

[Default]      **n** = 0

[Description] Turns quadruple-size mode on or off for multi-byte code character.

- When the LSB of **n** is 0, quadruple-size mode is turned off and normal size is specified.
- When the LSB of **n** is 1, quadruple-size mode is turned on.

[Notes]        ■ Settings of this command affect multilingual characters and user-defined characters.

                 ■ When a double-height mode is specified, a character is enlarged based on a baseline of the character and when a double-width mode is specified, a character is enlarged based on the left side of the character.

                 ■ Settings of this command are effective until **FS !** is executed, **GS !** is executed, **ESC @** is executed, the printer is reset, or the power is turned off.

### Program Example

```
PRINT #1, CHR$ (&H1C) ; "C" ; CHR$ (0) ;           ←Select JIS code system
PRINT #1, CHR$ (&H1C) ; "&" ;
PRINT #1, CHR$ (&H1C) ; "W" ; CHR$ (0) ;           ←Cancel quadruple-size mode
PRINT #1, CHR$ (&H34) ; CHR$ (&H41) ;
PRINT #1, CHR$ (&H3B) ; CHR$ (&H7A) ; CHR$ (&HA) ;
PRINT #1, CHR$ (&H1C) ; "W" ; CHR$ (1) ;           ←Specify quadruple-size mode
PRINT #1, CHR$ (&H34) ; CHR$ (&H41) ;
PRINT #1, CHR$ (&H3B) ; CHR$ (&H7A) ; CHR$ (&HA) ;
PRINT #1, CHR$ (&H1C) ; ". ." ;
```

### Print Sample

漢字                      ← Normal size  
 漢字                      ← Quadruple size

## FS ?

[Name] Cancel user-defined Kanji characters

[Format] ASCII FS ? **c1** **c2**  
 Hex 1C 3F **c1** **c2**  
 Decimal 28 63 **c1** **c2**

[Printers not featuring this command] **TM-T90**, **TM-T88IV**, **TM-T70**, **TM-L90**, **TM-P60**

[Range] The ranges of **c1** and **c2** differ, depending on specifications and the character code system used. The ranges of **c1** and **c2** for each model are as follows.

Models	<b>c1</b>	<b>c2</b>
Japanese model (JIS code)	<b>c1</b> = 77H	21H ≤ <b>c2</b> ≤ 7EH
Japanese model (SHIFT JIS code)	<b>c1</b> = ECH	40H ≤ <b>c2</b> ≤ 7EH, 80H ≤ <b>c2</b> ≤ 9EH
Simplified Chinese	<b>c1</b> = FEH	A1H ≤ <b>c2</b> ≤ FEH
Traditional Chinese	<b>c1</b> = FEH	A1H ≤ <b>c2</b> ≤ FEH

[Description] Deletes the user-defined Kanji character pattern specified by the character codes (**c1** and **c2**) of the currently selected Kanji font.

- **c1** specifies the first byte of a character code for a user-defined Kanji character.
- **c2** specifies the second byte of a character code for a user-defined Kanji character.

- [Notes]
- This command is effective only for Japanese, Simplified Chinese, and Traditional Chinese models.
  - After user-defined Kanji characters are canceled, a space is printed.
  - The foreign character pattern of the selected Kanji character font is deleted. Use function 48 of **FS ( A** to specify the Kanji character font.

# CONFIDENTIAL

[Model-dependent variations] None

## Program Example

```
PRINT #1, CHR$(&H1C);"C"; CHR$(0):           ←Select JIS code system
PRINT #1, CHR$(&H1C);"2";
PRINT #1, CHR$(&H77);CHR$(&H21);
FOR k = 1 To 32
  READ d: PRINT #1, CHR$(d);
NEXT k
PRINT #1, CHR$(&H1C);"&";                     ←Specify Kanji mode
PRINT #1, CHR$(&H77);CHR$(&H21);
PRINT #1, CHR$(&H33);CHR$(&H30);
PRINT #1, CHR$(&H3B);CHR$(&H7A);CHR$(&HA);
PRINT #1, CHR$(&H3B);CHR$(&H7A);CHR$(&HA);
PRINT #1, CHR$(&H1C);".";                     ←Cancel Kanji mode

DATA &H00, &H00, &H00, &H00, &H01, &HE0, &H07, &HF0
DATA &H0F, &HF0, &H1F, &HF2, &H3F, &HE2, &H7F, &HFE
DATA &H7F, &HFE, &H3F, &HE2, &H1F, &HF2, &H0F, &HF0
DATA &H07, &HF0, &H01, &HE0, &H00, &H00, &H00, &H00
```

## Print Sample

外字

## TWO DIMENSION CODE COMMANDS

---

Command	Name
---------	------

<b>GS ( k</b>	Set up and print the symbol
---------------	-----------------------------

[Name] Set up and print the symbol

[Printers not featuring this command] **TM-J2000/J2100**, **TM-U230**, **TM-U220**

[Description] Performs data processing related to 2-dimensional codes (PDF417, QR Code, MaxiCode, 2-dimensional RSS (Reduced Space Symbology), composite symbols).

- Symbol type is specified by **cn**
- Function code **fn** specifies the function.

<b>cn</b>	<b>fn</b>	<b>Function No.</b>	<b>Function name</b>
48	65	<b>Function 065</b>	PDF417: Set the number of columns in the data region
	66	<b>Function 066</b>	PDF417: Set the number of rows
	67	<b>Function 067</b>	PDF417: Set the width of the module
	68	<b>Function 068</b>	PDF417: Set the row height
	69	<b>Function 069</b>	PDF417: Set the error correction level
	70	<b>Function 070</b>	PDF417: Select the options
	80	<b>Function 080</b>	PDF417: Store the data in the symbol storage area
	81	<b>Function 081</b>	PDF417: Print the symbol data in the symbol storage area
	82	<b>Function 082</b>	PDF417: Transmit the size information of the symbol data in the symbol storage area
49	65	<b>Function 165</b>	QR Code: Select the model
	67	<b>Function 167</b>	QR Code: Set the size of module
	69	<b>Function 169</b>	QR Code: Select the error correction level
	80	<b>Function 180</b>	QR Code: Store the data in the symbol storage area
	81	<b>Function 181</b>	QR Code: Print the symbol data in the symbol storage area
	82	<b>Function 182</b>	QR Code: Transmit the size information of the symbol data in the symbol storage area

cn	fn	Function No.	Function name
50	65	<b>Function 265</b>	MaxiCode: Select the mode
	80	<b>Function 280</b>	MaxiCode: Store the data in the symbol storage area
	81	<b>Function 281</b>	MaxiCode: Print the symbol data in the symbol storage area
	82	<b>Function 282</b>	MaxiCode: Transmit the size information of the symbol data in the symbol storage area
51	67	<b>Function 367</b>	2-dimensional RSS: Module width setting
	71	<b>Function 371</b>	2-dimensional RSS: RSS Expanded Stacked maximum width setting
	80	<b>Function 380</b>	2-dimensional RSS: Store data in the symbol archive area
	81	<b>Function 381</b>	2-dimensional RSS: Print symbol archive area symbol data
	82	<b>Function 382</b>	2-dimensional RSS: Send symbol archive area symbol data size information
52	67	<b>Function 467</b>	Composite symbol: Module width setting
	71	<b>Function 471</b>	Composite symbol: RSS Expanded Stacked maximum width setting
	72	<b>Function 472</b>	Composite symbol: Select HRS character font
	80	<b>Function 480</b>	Composite symbol: Store data in the symbol archive area
	81	<b>Function 481</b>	Composite symbol: Print symbol archive area symbol data
	82	<b>Function 482</b>	Composite symbol: Send symbol archive area symbol data size information

- **pl, ph** specifies (**pl** + **ph** × 256) as the number of bytes after **ph** (**cn**, **fn**, and **[parameters]**). The **[parameters]** are described in each function.

## [Notes]

- The function is specified with the function code (**fn**). Details of the performance differ according to the function.

[Notes for processing of PDF417 symbol (when **cn** = 48)]

- The symbol data specified by Function 080 **d1...dk** is stored in the printer and is printed by Function 081.
- When processing Function 081 or 082, the setting values of Functions 065 to 070 are used. If the printable area is not large enough, the symbol may not be printed.
- Executing Function 081 after executing Function 080 repeatedly prints the same symbol.

- By using Functions 065 to 070 combined with Function 081, the same symbol data **d1...dk** is printed differently.
- By using Function 082, the symbol size printed by Function 081 is available.

[Notes for process of QR Code symbol (when **cn** = 49)]

- The symbol data specified by Function 180 **d1...dk** is stored in the printer and is printed by Function 181.
- When processing Function 181 or 182, the setting values of Functions 165, 167, 169 are used. If the printable area is not enough, the symbol may not be printed.
- Executing Function 181 after executing Function 180 repeatedly prints the same symbol.
- By using Functions 165, 167, 169 combined with Function 181, the same symbol data **d1...dk** is printed differently.
- By using Function 182, the symbol size printed by Function 181 is available.

[Notes for process of MaxiCode symbol (when specify **cn** = 50)]

- The symbol data specified by Function 280 **d1...dk** is stored in the printer and is printed by Function 281.
- When processing Function 281 or 282, the setting values of Function 265 are used. If the printable area is not enough, the symbol may not be printed.
- Executing Function 281 after executing Function 280 repeatedly prints the same symbol.
- By using Functions 265 combined with Function 281, the same symbol data **d1...dk** is printed differently.
- By using Function 282, the symbol size printed by Function 281 is available.

[Notes for 2-dimensional RSS (Reduced Space Symbology) processing (when **cn** = 51 is specified)]

- The 2-dimensional RSS symbol data specified by <Function 380> of this command (**d1...dk**) is temporarily stored in the archive area of the printer and is printed by <Function 381>.
- The setting value of <Function 367> is used when processing <Function 381> and <Function 382> of this command. Furthermore, the setting value of <Function 371> is used when processing RSS Expanded Stacked. If the printing area is narrow, it may not be possible to print the symbol.
- The same symbol can be printed by executing <Function 381> repeatedly after executing <Function 380> of this command.



- Using <Function 382> of this command, the size of the symbol printed with <Function 381> can be acquired.

[Notes for composite symbol processing (when **cn** = 52 is specified)]

- The composite symbol (line element/2D composite element) symbol data specified by <Function 480> of this command (**d1...dk**) is temporarily stored in the archive area of the printer and is printed by <Function 481>.
- The setting value of <Function 467> and <Function 472> is used when processing <Function 481> and <Function 482> of this command. Furthermore, the setting value of <Function 471> is used when processing RSS Expanded Stacked. If the printing area is narrow, it may not be possible to print the symbol.
- The same symbol can be printed by executing <Function 481> repeatedly after executing <Function 480> of this command.
- Composite symbols with a different combination can be printed by resending other symbol data with either of the line element or 2D composite element as it is.
  - Step 1) Specify <Function 480: (a = 49, b = 65)>, and send the 2D composite element data.
  - Step 2) Specify <Function 480: (a = 48, b = 70)>, and send the line element data.
  - Step 3) Print the composite symbol of which RSS-14 is the line element with <Function 481>.
  - Step 4) Specify <Function 480: (a = 48, b = 74)>, and send the line element data.
  - Step 5) Print the composite symbol of which RSS Limited is the line element with <Function 481>.
- Using <Function 482> of this command, the size of the symbol printed with <Function 481> can be acquired.

[Notes for transmission process]

- Transmission process is performed by <Function 082>, <Function 182>, and <Function 282>. When you use this command, follow these rules.
  - After the host PC transmits the function data, the printer will send response data or status data back to the PC. Do not transmit more data from the PC until the corresponding data is received from the printer.
  - When operating with a serial interface, be sure to configure operation so that the host computer uses these functions only when it is READY.

- With a parallel interface, a [Header ~ NUL] is stored at first in the transmission buffer of the printer with the other transmission data (except for ASB status). When the host enters Reverse Mode, the data is transmitted in order from the beginning. Data that exceeds the transmission buffer size (99 bytes) is ignored. When using the command, the host should enter Reverse Mode immediately and execute receive processing of status.
- When communication with the printer uses XON/XOFF control with serial interface, the XOFF code may interrupt the "Header to NUL" data string.
- The information for each function can be identified to other transmission data according to specific data of the transmission data block. When the header transmitted by the printer is [hex = 37H/decimal =55], treat NUL [hex = 00H/decimal =0] as a data group and identify it according to the combination of the header and the identifier.

[Model-dependent variations]

**TM-T90, TM-T88IV, TM-T70, TM-L90, TM-P60**

### Program Example1 (Print a symbol repeatedly)

```
>PRINT #1, CHR$( &H1D ); " (k";CHR$( 13 );CHR$( 0 );CHR$( 48 );CHR$( 80 );CHR$( 48 ); "TEST PRINT"; ←Save data <Function080>
>PRINT #1, CHR$( &H1D ); " (k";CHR$( 3 );CHR$( 0 );CHR$( 48 );CHR$( 81 );CHR$( 48 ); ←Print symbol <Function081>
>PRINT #1, CHR$( &H1D ); " (k";CHR$( 3 );CHR$( 0 );CHR$( 48 );CHR$( 81 );CHR$( 48 ); ←Print symbol <Function081>
```

### Program Example2 (Print a symbol which module width is different)

```
>PRINT #1, CHR$( &H1D ); " (k";CHR$( 13 );CHR$( 0 );CHR$( 48 );CHR$( 80 );CHR$( 48 ); "TEST PRINT"; ←Save data <Function080>
>PRINT #1, CHR$( &H1D ); " (k";CHR$( 3 );CHR$( 0 );CHR$( 48 );CHR$( 67 );CHR$( 3 ); ←Set module width to 3 <Function067>
>PRINT #1, CHR$( &H1D ); " (k";CHR$( 3 );CHR$( 0 );CHR$( 48 );CHR$( 81 );CHR$( 48 ); ←Print symbol <Function081>
>PRINT #1, CHR$( &H1D ); " (k";CHR$( 3 );CHR$( 0 );CHR$( 48 );CHR$( 67 );CHR$( 5 ); ←Set module width to 5 <Function067>
>PRINT #1, CHR$( &H1D ); " (k";CHR$( 3 );CHR$( 0 );CHR$( 48 );CHR$( 81 );CHR$( 48 ); ←Print symbol <Function081>
```

## TM-T90

**This model supports two-dimensional code (PDF417 )**

**When printing PDF417 with this printer, note the following:**

# CONFIDENTIAL

- The recognition rate of the symbol is affected by the height of the symbol, module height, module width ratio, and the performance of the reader.
- It is recommended that the module height and module width be set so that the height of the symbol is bigger than 5 mm {0.2 inch}.
- It is recommended that the module height be set three to five times the width of the module.
- The module height is specified by Function 068. The width of a module is specified by Function 067. The number of the rows is specified by Function 066.
- The size of the symbol is confirmed by the transmission data of Function 082.

## **TM-T88IV, TM-T70**

[Other than Japanese Model]

This model supports two-dimensional code (PDF417, QR Code)

When printing PDF417 with this printer, note the following:

The recognition rate of the symbol is affected by the height of the symbol, module height, module width ratio, and the performance of the reader.

It is recommended that the module height and module width be set so that the height of the symbol is bigger than 5 mm {0.2 inch}.

It is recommended that the module height be set three to five times the width of the module.

The module height is specified by Function 068. The width of a module is specified by Function 067. The number of the rows is specified by Function 066.

The size of the symbol is confirmed by the transmission data of Function 082.

[Japanese model]

This model supports two-dimensional code (QR Code)

## **TM-P60**

[**TM-P60 with Peeler**]

**This model supports two-dimensional code (PDF417, RSS (Reduced Space Symbology), Composite symbols).**

When printing PDF417 with this printer, note the following:

- The recognition rate of the symbol is affected by the height of the symbol, module height, module width ratio, and the performance of the reader.
  - It is recommended that the module height and module width be set so that the height of the symbol is greater than 5 mm {0.2 inch}.
  - It is recommended that the module height be set three to five times the width of the module.
  - The module height is specified by Function 068. The width of a module is specified by Function 067. The number of the rows is specified by Function 066.
  - The size of the symbol is confirmed by the transmission data of Function 082.
- [TM-P60 models without Peeler]

These models do not support this function.

## TM-L90

This model supports two-dimensional code (PDF417, QR Code, MaxiCode )

When printing PDF417 with this printer, note the following:

- The recognition rate of the symbol is affected by the height of the symbol, module height, module width ratio, and the performance of the reader.
- It is recommended that the module height and the width of a module be set so that the height of the symbol is bigger than 5 mm {0.2 inch}.
- It is recommended that the module height be set to three to five times the width of the module.
- The module height is specified by Function 068. The width of a module is specified by Function 067. The number of the rows is specified by Function 066.
- The size of the symbol is confirmed by the transmission data of Function 082.

## GS ( k <Function 065>

---

[Name] PDF417: Set the number of columns in the data region

[Format] ASCII GS ( k **pL pH cn fn n**  
 Hex 1D 28 6B **03 00 30 41 n**  
 Decimal 29 40 107 **3 0 48 65 n**

[Range]  $(pL + pH \times 256) = 3$  (**pL =3, pH =0**)  
**cn = 48**  
**fn = 65**  
 $0 \leq n \leq 30$

[Default] **n = 0**

[Description] Sets the number of columns in the data region for PDF417.

- When **n = 0**, specifies automatic processing
- When **n** is not 0, sets the number of columns in the data region to **n** codeword.

- [Notes]
- Settings of this function affect the processing of Functions 081 and 082.
  - When auto processing (**n = 0**) is specified, the maximum number of columns in the data area is 30 columns.
  - The following data is not included in the number of columns:
    - Start pattern and stop pattern
    - Indicator codeword of left and right
  - When automatic processing (**n = 0**) is specified, the number of columns is calculated by the print area when processing Functions 081, 082, module width (Function 067), and option setting (Function 070).
  - Settings of this function are effective until **ESC @** is executed, the printer is reset, or the power is turned off.

[Model-dependent variations] **TM-T88IV, TM-T70, TM-P60**

**TM-T88IV, TM-T70**

**This function is not supported in the Japanese specification.**

# C O N F I D E N T I A L

## **TM-P60**

**TM-P60 with Peeler supports this function.**

## GS ( k <Function 066>

---

[Name]	PDF417: Set the number of rows																								
[Format]	<table> <tr> <td>ASCII</td> <td>GS (</td> <td>k</td> <td><b>pL</b></td> <td><b>pH</b></td> <td><b>cn</b></td> <td><b>fn</b></td> <td><b>n</b></td> </tr> <tr> <td>Hex</td> <td>1D 28 6B</td> <td><b>03</b></td> <td><b>00</b></td> <td><b>30</b></td> <td><b>42</b></td> <td><b>n</b></td> <td></td> </tr> <tr> <td>Decimal</td> <td>29 40 107</td> <td><b>3</b></td> <td><b>0</b></td> <td><b>48</b></td> <td><b>66</b></td> <td><b>n</b></td> <td></td> </tr> </table>	ASCII	GS (	k	<b>pL</b>	<b>pH</b>	<b>cn</b>	<b>fn</b>	<b>n</b>	Hex	1D 28 6B	<b>03</b>	<b>00</b>	<b>30</b>	<b>42</b>	<b>n</b>		Decimal	29 40 107	<b>3</b>	<b>0</b>	<b>48</b>	<b>66</b>	<b>n</b>	
ASCII	GS (	k	<b>pL</b>	<b>pH</b>	<b>cn</b>	<b>fn</b>	<b>n</b>																		
Hex	1D 28 6B	<b>03</b>	<b>00</b>	<b>30</b>	<b>42</b>	<b>n</b>																			
Decimal	29 40 107	<b>3</b>	<b>0</b>	<b>48</b>	<b>66</b>	<b>n</b>																			
[Range]	$(pL + pH \times 256) = 3$ ( <b>pL</b> =3, <b>pH</b> =0) <b>cn</b> = 48 <b>fn</b> = 66 <b>n</b> = 0, $3 \leq n \leq 90$																								
[Default]	<b>n</b> = 0																								
[Description]	<p>Sets the number of rows for PDF417.</p> <ul style="list-style-type: none"> <li>When <b>n</b> = 0 specifies automatic processing.</li> <li>When <b>n</b> is not 0, sets the number of rows to <b>n</b> rows.</li> </ul>																								
[Notes]	<ul style="list-style-type: none"> <li>Settings of this function affect the processing of Functions 081 and 082.</li> <li>When automatic processing (<b>n</b> = 0) is specified, the maximum number of rows is 90.</li> <li>When automatic processing (<b>n</b> = 0) is specified, the number of rows is calculated by the print area when processing Functions 081, 082, and module height (Function 068).</li> <li>Settings of this function are effective until <b>ESC @</b> is executed, the printer is reset, or the power is turned off.</li> </ul>																								
[Model-dependent variations]	<b>TM-T88IV</b> , <b>TM-T70</b> , <b>TM-P60</b>																								

### **TM-T88IV**, **TM-T70**

This function is not supported in the Japanese specification.

### **TM-P60**

**TM-P60 with Peeler supports this function.**

## GS ( k <Function 067>

---

[Name]	PDF417: Set the width of the module																								
[Format]	<table border="0"> <tr> <td>ASCII</td> <td>GS (</td> <td>k</td> <td><b>pL</b></td> <td><b>pH</b></td> <td><b>cn</b></td> <td><b>fn</b></td> <td><b>n</b></td> </tr> <tr> <td>Hex</td> <td>1D 28 6B</td> <td><b>03</b></td> <td><b>00</b></td> <td><b>30</b></td> <td><b>43</b></td> <td><b>n</b></td> <td></td> </tr> <tr> <td>Decimal</td> <td>29 40 107</td> <td><b>3</b></td> <td><b>0</b></td> <td><b>48</b></td> <td><b>67</b></td> <td><b>n</b></td> <td></td> </tr> </table>	ASCII	GS (	k	<b>pL</b>	<b>pH</b>	<b>cn</b>	<b>fn</b>	<b>n</b>	Hex	1D 28 6B	<b>03</b>	<b>00</b>	<b>30</b>	<b>43</b>	<b>n</b>		Decimal	29 40 107	<b>3</b>	<b>0</b>	<b>48</b>	<b>67</b>	<b>n</b>	
ASCII	GS (	k	<b>pL</b>	<b>pH</b>	<b>cn</b>	<b>fn</b>	<b>n</b>																		
Hex	1D 28 6B	<b>03</b>	<b>00</b>	<b>30</b>	<b>43</b>	<b>n</b>																			
Decimal	29 40 107	<b>3</b>	<b>0</b>	<b>48</b>	<b>67</b>	<b>n</b>																			
[Range]	<p><b>(pL + pH × 256) = 3 (pL =3, pH =0)</b>  <b>cn = 48</b>  <b>fn = 67</b>  <b>TM-T90, TM-T88IV, TM-T70, TM-L90, TM-P60: 2 ≤ n ≤ 8</b></p>																								
[Default]	<b>TM-T90, TM-T88IV, TM-T70, TM-L90, TM-P60: n = 3</b>																								
[Description]	Sets the width of the module for PDF417 to <b>n</b> dots.																								
[Notes]	<ul style="list-style-type: none"> <li>■ Settings of this function affect the processing of Functions 081 and 082.</li> <li>■ Settings of this function are effective until <b>ESC @</b> is executed, the printer is reset, or the power is turned off.</li> </ul>																								
[Model-dependent variations]	<b>TM-T90, TM-T88IV, TM-T70, TM-L90, TM-P60</b>																								

### TM-T90

The setting unit is 1 dot.

With all models other than the Japanese model, the width is set in units of 0.141 mm {1/180 inch}.

With the Japanese model, the width is set in units of 0.125 mm {1/203 inch}.

### TM-T88IV, TM-T70

This function is not supported in the Japanese specification.

The setting unit is 1 dot. The width is set in units of 0.141 mm {1/180 inch}.

### TM-L90

The setting unit is 1 dot. The width is set in units of 0.125 mm {1/203 inch}.



# CONFIDENTIAL

## TM-P60

The setting unit is 1 dot. The width is set in units of 0.125 mm {1/203 inch}.

## GS ( k <Function 068>

---

[Name] PDF417: Set the row height

[Format]	ASCII	GS (	k	<b>pL</b>	<b>pH</b>	<b>cn</b>	<b>fn</b>	<b>n</b>
	Hex	1D 28 6B	<b>03</b>	<b>00</b>	<b>30</b>	<b>44</b>	<b>n</b>	
	Decimal	29 40 107	<b>3</b>	<b>0</b>	<b>48</b>	<b>68</b>	<b>n</b>	

[Range] **(pL + pH × 256) = 3 (pL = 3, pH =0)**  
**cn = 48**  
**fn = 68**

**TM-T90, TM-T88IV, TM-T70, TM-L90, TM-P60: 2 ≤ n ≤ 8**

[Default] **TM-T90, TM-T88IV, TM-T70, TM-L90, TM-P60: n = 3**

[Description] Sets the row height for PDF417 to [n × (the width of the module)].

- [Notes]
- Settings of this function affect the processing of Functions 081 and 082.
  - Settings of this function are effective until **ESC @** is executed, the printer is reset, or the power is turned off.

[Model-dependent variations] **TM-T90, TM-L90, TM-T88IV, TM-T70, TM-P60**

### **TM-T90, TM-L90**

**The module height influences the recognition rate of the symbol.**

**The module height is recommended to be set to 3-5 times the module width.**

**The recognition rate might decrease when the vertical size of the symbol is 5 mm {0.2"} or less.**

**The vertical size of the symbol can be confirmed by the transmission data of Function 082.**

### **TM-T88IV, TM-T70**

**This function is not supported in the Japanese specification.**

**The module height influences the recognition rate of the symbol.**

**The module height is recommended to be set to 3-5 times the module width.**

**The recognition rate might decrease when the vertical size of the symbol is 5 mm {0.2"} or less.**

**The vertical size of the symbol can be confirmed by the transmission data of Function 082.**

## TM-P60

**TM-P60 with peeler supports this function.**

**The module height influences the recognition rate of the symbol.**

**The module height is recommended to be set to 3-5 times the module width.**

**The recognition rate might decrease when the vertical size of the symbol is 5 mm {0.2"} or less.**

**The vertical size of the symbol can be confirmed by the transmission data of Function 082.**

## GS ( k <Function 069>

[Name] PDF417: Set the error correction level

[Format] ASCII GS ( k **pl pH cn fn m n**  
 Hex 1D 28 6B **04 00 30 45 m n**  
 Decimal 29 40 107 **4 0 48 69 m n**

[Range] (**pl + pH × 256**) = 4 (**pl = 4, pH = 0**)  
**cn = 48**  
**fn = 69**  
**m = 48, 49**  
**48 ≤ n ≤ 56 [m = 48]**  
**1 ≤ n ≤ 40 [m = 49]**

[Default] **m = 49, n = 1** [ratio: 10%]

[Description] Sets the error correction level for PDF417.

<b>m</b>	<b>Function</b>
48	The error correction level is set by "level."
49	The error correction level is set by "ratio." The ratio is [ <b>n × 10%</b> ].

- [Notes]
- Settings of this function affect the processing of Functions 081 and 082.
  - Error correction level is specified by either "level" or "ratio."
  - Error correction level specified by "level" (**m = 48**) is as follows. The number of the error correction codeword is fixed regardless of the number of codewords in the data area.

<b>n</b>	<b>Function</b>	<b>Number of error correction codeword</b>
48	Error correction level 0	2
49	Error correction level 1	4
50	Error correction level 2	8

<b>n</b>	<b>Function</b>	<b>Number of error correction codeword</b>
51	Error correction level 3	16
52	Error correction level 4	32
53	Error correction level 5	64
54	Error correction level 6	128
55	Error correction level 7	256
56	Error correction level 8	512

- Error correction level specified by "ratio" (**m** = 49) is as follows. The error correction level is defined by the calculated value [number of data codeword  $\times$  **n**  $\times$  0.1 = (A)]. The number of the error correction codeword is changeable in proportion to the number of the codeword in the data area.

<b>Calculated value (A)</b>	<b>Correction level</b>	<b>Number of error correction codeword</b>
0 – 3	Error correction level 1	4
4 – 10	Error correction level 2	8
11 – 20	Error correction level 3	16
21 – 45	Error correction level 4	32
46 – 100	Error correction level 5	64
101 – 200	Error correction level 6	128
201 – 400	Error correction level 7	256
401 or more	Error correction level 8	512

- The error correction codeword calculated by modulus 929.
- Settings of this function are effective until **ESC @** is executed, the printer is reset, or the power is turned off.

[Model-dependent variations]

**TM-T88IV**, **TM-T70**, **TM-P60**

# CONFIDENTIAL

## **TM-T88IV, TM-T70**

This function is not supported in the Japanese specification.

## **TM-P60**

**TM-P60 with Peeler supports this function.**

## GS ( k <Function 070>

[Name]	PDF417: Select the options									
[Format]	ASCII	GS (	k	<b>pL</b>	<b>pH</b>	<b>cn</b>	<b>fn</b>	<b>n</b>		
	Hex	1D 28	6B	<b>03</b>	<b>00</b>	<b>30</b>	<b>46</b>	<b>n</b>		
	Decimal	29 40	107	<b>3</b>	<b>0</b>	<b>48</b>	<b>70</b>	<b>n</b>		
[Range]	$(\mathbf{pL} + \mathbf{pH} \times 256) = 3$ ( <b>pL</b> =3, <b>pH</b> =0) <b>cn</b> = 48 <b>fn</b> = 70 <b>m</b> = 0,1									
[Default]	<b>m</b> = 0									
[Description]	Selects the option for PDF417.									

<b>m</b>	<b>Function</b>
0	Selects the standard PDF417.
1	Selects the truncated PDF417.

- [Notes]**
- Settings of this function affect the processing of Functions 081 and 082.
  - Settings of this function are effective until **ESC @** is executed, the printer is reset, or the power is turned off.

[Model-dependent variations]      **TM-T88IV, TM-T70, TM-P60**

### **TM-T88IV, TM-T70**

**This function is not supported in the Japanese specification.**

### **TM-P60**

**TM-P60 with Peeler supports this function.**

## GS ( k <Function 080>

---

[Name] PDF417: Store the data in the symbol storage area

[Format] ASCII GS ( k **pl pH cn fn m d1...dk**  
 Hex 1D 28 6B **pl pH 30 50 30 d1...dk**  
 Decimal 29 40 107 **pl pH 48 80 48 d1...dk**

[Range]  $4 \leq (\mathbf{pl} + \mathbf{pH} \times 256) \leq 65535$  ( $0 \leq \mathbf{pl} \leq 255, 0 \leq \mathbf{pH} \leq 255$ )  
**cn** = 48  
**fn** = 80  
**m** = 48  
 $0 \leq \mathbf{d} \leq 255$   
**k** =  $(\mathbf{pl} + \mathbf{pH} \times 256) - 3$

[Description] Stores the PDF417 symbol data (**d1...dk**) in the symbol storage area.

- [Notes]
- The symbol data saved in the symbol archive area by this function is encoded by <Function 081> and <Function 082> of this command. After <Function 081> and <Function 082> are executed, the symbol archive area symbol data is kept.
  - **k** bytes of **d1...dk** are processed as symbol data.
  - Specify only the data codeword of the symbol with this function. Be sure not to include the following data in the data **d1...dk** because they are added automatically by the printer.
    - Start pattern and stop pattern
    - Indicator codeword of left and right
    - The descriptor of symbol length (the first codeword in the data area)
    - The error correction codeword calculated by modulus 929
  - Settings of this function are effective until the following processing is performed:
    - Function 080 or 180 or 280 or 380 or 480 is executed
    - **ESC @** is executed
    - The printer is reset or the power is turned off

[Model-dependent variations] **TM-T88IV, TM-T70, TM-P60**



# CONFIDENTIAL

## **TM-T88IV, TM-T70**

This function is not supported in the Japanese specification.

## **TM-P60**

**TM-P60 with Peeler supports this function.**

## GS ( k <Function 081>

---

[Name] PDF417: Print the symbol data in the symbol storage area

[Format]

ASCII	GS (	k	<b>pL</b>	<b>pH</b>	<b>cn</b>	<b>fn</b>	<b>m</b>
Hex	1D 28 6B	<b>03</b>	<b>00</b>	<b>30</b>	<b>51</b>	<b>m</b>	
Decimal	29 40 107	<b>3</b>	<b>0</b>	<b>48</b>	<b>81</b>	<b>m</b>	

[Range] (**pL** + **pH** × 256) = 3 (**pL** = 3, **pH** = 0)  
**cn** = 48  
**fn** = 81  
**m** = 48

[Description] Encodes and prints the PDF417 symbol data in the symbol storage area using the process of <Function 080>.

- [Notes]
- In standard mode, use this function when printer is “at the beginning of a line,” or “there is no data in the print buffer.”
  - A symbol that size exceeds the print area cannot be printed.
  - If there is any error described below in the data of the symbol storage area, it cannot be printed.
    - There is no data (Function 080 is not processed).
    - If [(number of columns × number of rows) < number of codeword] when auto processing is specified for number of columns and number of rows.
    - Number of codeword exceeds 928 in the data area.
  - The following data are added automatically by the encode processing.
    - Start pattern and stop pattern
    - Indicator codeword of left and right
    - The descriptor of symbol length (the first codeword in the data area)
    - The error correction codeword calculated by modulus 929
    - Pad codeword

- The data area includes the following codeword.
  - Data specified by Function 080.
  - The descriptor of symbol length (the first codeword in the data area).
  - The error correction codeword calculated by modulus 929.
  - Pad codeword
- When auto processing (Function 065) is specified, the number of columns is calculated by the current print area, module width (Function 067), option setting (Function 070), and the codeword in the data area. Maximum number of the columns is 30.
- When auto processing (Function 066) is specified in page mode, the number of rows is calculated by the current print area, module height (Function 068), and the codeword in the data area. The maximum number of rows is 90.
- Printing of symbol is not affected by print mode (emphasized, double-strike, underline, white/ black reverse printing, or 90° clockwise-rotated), except for character size and upside-down print mode.
- In standard mode, this command executes paper feeding for the amount needed for printing the symbol, regardless of the paper feed amount set by the paper feed setting command. The print position returns to the left side of the printable area after printing the symbol, and printer is in the status "beginning of the line," or "there is no data in the print buffer."
- In page mode, the printer stores the symbol data in the print buffer without executing actual printing. The printer moves print position to the next dot of the last data of the symbol.
- The quiet zone is not included in the printing data. Be sure to include the quiet zone when using this function.

[Model-dependent variations]

**TM-T90, TM-L90, TM-T88IV, TM-T70, TM-P60**

## **TM-T90, TM-L90**

**In standard mode, the symbol which height exceeds 831 dots cannot be printed with this printer.**

**When printing PDF417 symbols, the printer starts actual printing after it reaches control speed for printing symbol. The paper must be fed 10 dots or less in this operation. This area is not included in the vertical area transmitted by Function 082.**

# CONFIDENTIAL

## **TM-T88IV, TM-T70**

This function is not supported in the Japanese specification.

In standard mode, the symbol which height exceeds 831 dots cannot be printed with this printer.

When printing PDF417 symbols, the printer starts actual printing after it reaches control speed for printing symbol. The paper must be fed 10 dots or less in this operation. This area is not included in the vertical area transmitted by Function 082.

## **TM-P60**

**TM-P60 with peeler supports this function.**

In standard mode, a symbol higher than 1200 dots cannot be printed with this printer.

PDF417 symbols are printed with the "printing control mode = fine" regardless of the setting of Function 48 of **GS ( K**.

## GS ( k <Function 082>

[Name] PDF417: Transmit the size information of the symbol data in the symbol storage area

[Format] ASCII GS ( k **pl** **ph** **cn** **fn** **m**  
 Hex 1D 28 6B **03** **00** **30** **52** **m**  
 Decimal 29 40 107 **3** **0** **48** **82** **m**

[Range] (**pl** + **ph** × 256) = 3 (**pl** = 3, **ph** = 0)  
**cn** = 48  
**fn** = 82  
**m** = 48

[Description] Transmits the size information for the encoded PDF417 symbol data in the symbol storage area using the process of <Function 080>.

- [Notes]
- In standard mode, use this function when the printer is “at the beginning of a line,” or “there is no data in the print buffer.”
  - The size information for each data is as follows;

Send data	Hex	Decimal	Data
Header	37H	55	1 byte
Identifier	2FH	47	1 byte
Horizontal size (*1)	30H –39H	48 –57	1 –5 byte
Separator	1FH	31	1 byte
Vertical size (*1)	30H –39H	48 –57	1 –5 byte
Separator	1FH	31	1 byte
Fixed value	31H	49	1 byte
Separator	1FH	31	1 byte
Other information (*2)	30H or 31H	48 or49	1 byte
NUL	00H	0	1 byte

(\*1)“Horizontal size” and “vertical size” indicate the number of dots of the symbol. The decimal value of the vertical size and horizontal size is converted to text data and sent starting from the high order end.  
 (ex: When horizontal size is 120 dots, horizontal size is “120” (in hexadecimal: 31H, 32H, and 30H / in decimal: 49, 50, and 48 ), which is 3 bytes of data.)

(\*2)“Other information” indicates whether printing of the data in the symbol storage area is possible or impossible. The “Other information” is the following.

**<Other information>**

Hex	Decimal	Condition
30H	48	Printing is possible
31H	49	Printing is impossible

- Size information indicates size of symbol that is printed by Function 081.
- The quiet zone is not included in the size information.
- If “other information” is “Printing is impossible”(in decimal: 49), use one of the following solutions:

Cause	Solution
There are data in the print buffer in the standard mode	Put the printer in the state “there is no data in the print buffer” by executing <b>GS T</b> or print commands ( <b>LF, CR, ESC J</b> ).
Symbol is bigger than the current print area.	Expand the print area by <b>GS W, ESC W, ESC \$</b> . Reduce the module width by Function 067. Reduce the module height by Function 068. Lower the error correction level by Function 069.

Cause	Solution
(Number of columns × number of rows) < number of codeword	Increase the number of columns by Function 065. Increase the number of rows by Function 066.
Number of the codeword in the data area is more than 928.	Reduce the data by Function 080. Lower the error correction level by Function 069.
There is no data in the symbol storage area.	Sends data to the symbol storage area by Function 080.

■ See previous [Notes for transmission process] for process sending data group.

[Model-dependent variations]

**TM-T90, TM-L90, TM-T88IV, TM-T70, TM-P60**

## **TM-T90, TM-L90**

**When the vertical size exceeds 831 dots in standard mode, "other information" is "Printing is impossible"(in decimal: 49).**

## **TM-T88IV, TM-T70**

**This function is not supported in the Japanese specification.**

**When the vertical size exceeds 831 dots in standard mode, "other information" is "Printing is impossible"(in decimal: 49).**

## **TM-P60**

**TM-P60 with peeler supports this function.**

**When the vertical size exceeds 1200 dots in standard mode, "other information" is "Printing is impossible"(in decimal: 49).**

## GS ( k <Function 165>

---

[Name]	QR Code: Select the model									
[Format]	ASCII	GS (	k	<b>pL</b>	<b>pH</b>	<b>cn</b>	<b>fn</b>	<b>n1</b>	<b>n2</b>	
	Hex	1D 28	6B	<b>04</b>	<b>00</b>	<b>31</b>	<b>41</b>	<b>n1</b>	<b>n2</b>	
	Decimal	29 40	107	<b>4</b>	<b>0</b>	<b>49</b>	<b>65</b>	<b>n1</b>	<b>n2</b>	

[Range] **(pL + pH × 256) = 4 (pL = 4, pH = 0)**  
**cn = 49**  
**fn = 65**  
**n1 = 49, 50**  
**n2 = 0**

[Default] **n1 = 50, n2 = 0**

[Description] Selects the model for QR Code.

<b>n1</b>	<b>Function</b>
49	Selects model 1.
50	Selects model 2.

- [Notes]
- Settings of this function affect the processing of Functions 181 and 182.
  - Settings of this function are effective until **ESC @** is executed, the printer is reset, or the power is turned off.

[Model-dependent variations] **TM-T90, TM-P60**

### **TM-T90**

**This model does not support this function.**

### **TM-P60**

**TM-P60 with peeler supports this function.**



## GS ( k <Function 167>

---

[Name]	QR Code: Set the size of module																								
[Format]	<table border="0"> <tr> <td>ASCII</td> <td>GS (</td> <td>k</td> <td><b>pL</b></td> <td><b>pH</b></td> <td><b>cn</b></td> <td><b>fn</b></td> <td><b>n</b></td> </tr> <tr> <td>Hex</td> <td>1D 28 6B</td> <td><b>03</b></td> <td><b>00</b></td> <td><b>31</b></td> <td><b>43</b></td> <td><b>n</b></td> <td></td> </tr> <tr> <td>Decimal</td> <td>29 40 107</td> <td><b>3</b></td> <td><b>0</b></td> <td><b>49</b></td> <td><b>67</b></td> <td><b>n</b></td> <td></td> </tr> </table>	ASCII	GS (	k	<b>pL</b>	<b>pH</b>	<b>cn</b>	<b>fn</b>	<b>n</b>	Hex	1D 28 6B	<b>03</b>	<b>00</b>	<b>31</b>	<b>43</b>	<b>n</b>		Decimal	29 40 107	<b>3</b>	<b>0</b>	<b>49</b>	<b>67</b>	<b>n</b>	
ASCII	GS (	k	<b>pL</b>	<b>pH</b>	<b>cn</b>	<b>fn</b>	<b>n</b>																		
Hex	1D 28 6B	<b>03</b>	<b>00</b>	<b>31</b>	<b>43</b>	<b>n</b>																			
Decimal	29 40 107	<b>3</b>	<b>0</b>	<b>49</b>	<b>67</b>	<b>n</b>																			
[Range]	<p><b>(pL + pH × 256) = 3 (pL = 3, pH = 0)</b>  <b>cn = 49</b>  <b>fn = 67</b>  <b>TM-T88IV, TM-T70, TM-L90, TM-P60: 1 ≤ n ≤ 16</b></p>																								
[Default]	<b>TM-T88IV, TM-T70, TM-L90, TM-P60: n = 3</b>																								
[Description]	Sets the size of the module for QR Code to <b>n</b> dots.																								
[Notes]	<ul style="list-style-type: none"> <li>■ Settings of this function affect the processing of Functions 181 and 182.</li> <li>■ Settings of this function are effective until <b>ESC @</b> is executed, the printer is reset, or the power is turned off.</li> <li>■ <b>n</b> = width of a module = height of a module. (Because the QR code modules are square.)</li> </ul>																								
[Model-dependent variations]	<b>TM-T90, TM-T88IV, TM-T70, TM-L90, TM-P60</b>																								

### TM-T90

This model does not support this function.

### TM-T88IV

The setting unit is 1 dot. The size is set in units of 0.141 mm {1/180 inch}.

### TM-T70

The setting unit is 1 dot.

For other than Japanese model, one dot corresponds to 0.141 mm {1/180 inch}.

For Japanese model, one dot corresponds to 0.125 mm {1/203 inch}.

# CONFIDENTIAL

## **TM-L90**

The setting unit is 1 dot. The size is set in units of 0.125 mm {1/203 inch}.

## **TM-P60**

**TM-P60 with peeler supports this function.**

The setting unit is 1 dot. The size is set in units of 0.125 mm {1/203 inch}.

## GS ( k <Function 169>

---

[Name] QR Code: Select the error correction level

[Format] ASCII GS ( k **pL pH cn fn n**  
 Hex 1D 28 6B **03 00 31 45 n**  
 Decimal 29 40 107 **3 0 49 69 n**

[Range]  $(pL + pH \times 256) = 3$  (**pL = 3, pH = 0**)  
**cn = 49**  
**fn = 69**  
 $48 \leq n \leq 51$

[Default] **n = 48**

[Description] Selects the error correction level for QR Code.

n	Function	Recovery Capacity % (approx.)
48	Selects Error correction level L	7
49	Selects Error correction level M	15
50	Selects Error correction level Q	25
51	Selects Error correction level H	30

- [Notes]
- Settings of this function affect the processing of Functions 181 and 182.
  - QR Code employs Reed-Solomon error correction to generate a series of error correction codewords.
  - Settings of this function are effective until **ESC @** is executed, the printer is reset, or the power is turned off.

[Model-dependent variations] **TM-T90, TM-P60**

### TM-T90

**This model does not support this function.**

# CONFIDENTIAL

## TM-P60

**TM-P60 with peeler supports this function.**

## GS ( k <Function 180>

---

[Name] QR Code: Store the data in the symbol storage area

[Format] ASCII GS ( k **pl pH cn fn m d1...dk**  
 Hex 1D 28 6B **pl pH 31 50 30 d1...dk**  
 Decimal 29 40 107 **pl pH 49 80 48 d1...dk**

[Range]  $4 \leq (\mathbf{pl} + \mathbf{pH} \times 256) \leq 7092$  ( $0 \leq \mathbf{pl} \leq 255, 0 \leq \mathbf{pH} \leq 27$ )  
**cn** = 49  
**fn** = 80  
**m** = 48  
 $0 \leq \mathbf{d} \leq 255$   
**k** =  $(\mathbf{pl} + \mathbf{pH} \times 256) - 3$

[Description] Stores the QR Code symbol data (**d1...dk**) in the symbol storage area.

- [Notes]
- The symbol data saved in the symbol archive area by this function is encoded by <Function 081> and <Function 082> of this command. After <Function 081> and <Function 082> are executed, the symbol archive area symbol data is kept.
  - **k** bytes of **d1...dk** are processed as symbol data.
  - It is possible to encode to a QR Code as follows. Be sure not to include anything except the following data in the data **d1...dk**.

Category of data	Characters it is possible to specify
Numerical Mode data	"0" ~ "9"
Alphanumeric Mode data	"0" ~ "9", "A" ~ "Z", SP, \$, %, *, +, -, ., /, :
Kanji Mode data	Shift JIS value (Shift value from JISX0208)
8-Bit Byte Mode data	00H ~ FFH

- Settings of this function are effective until the following processing is performed:
  - Function 080 or 180 or 280 or 380 or 480 is executed
  - **ESC @** is executed

# CONFIDENTIAL

- The printer is reset or the power is turned off

[Model-dependent variations]

**TM-T90, TM-P60**

## **TM-T90**

**This model does not support this function.**

## **TM-P60**

**TM-P60 with peeler supports this function.**

## GS ( k <Function 181>

---

[Name]	QR Code: Print the symbol data in the symbol storage area																								
[Format]	<table border="0"> <tr> <td>ASCII</td> <td>GS (</td> <td>k</td> <td><b>pL</b></td> <td><b>pH</b></td> <td><b>cn</b></td> <td><b>fn</b></td> <td><b>m</b></td> </tr> <tr> <td>Hex</td> <td>1D 28 6B</td> <td><b>03</b></td> <td><b>00</b></td> <td><b>31</b></td> <td><b>51</b></td> <td><b>m</b></td> <td></td> </tr> <tr> <td>Decimal</td> <td>29 40 107</td> <td><b>3</b></td> <td><b>0</b></td> <td><b>49</b></td> <td><b>81</b></td> <td><b>m</b></td> <td></td> </tr> </table>	ASCII	GS (	k	<b>pL</b>	<b>pH</b>	<b>cn</b>	<b>fn</b>	<b>m</b>	Hex	1D 28 6B	<b>03</b>	<b>00</b>	<b>31</b>	<b>51</b>	<b>m</b>		Decimal	29 40 107	<b>3</b>	<b>0</b>	<b>49</b>	<b>81</b>	<b>m</b>	
ASCII	GS (	k	<b>pL</b>	<b>pH</b>	<b>cn</b>	<b>fn</b>	<b>m</b>																		
Hex	1D 28 6B	<b>03</b>	<b>00</b>	<b>31</b>	<b>51</b>	<b>m</b>																			
Decimal	29 40 107	<b>3</b>	<b>0</b>	<b>49</b>	<b>81</b>	<b>m</b>																			
[Range]	<p><math>(\mathbf{pL} + \mathbf{pH} \times 256) = 3</math> (<math>\mathbf{pL} = 3, \mathbf{pH} = 0</math>)</p> <p><b>cn</b> = 49</p> <p><b>fn</b> = 81</p> <p><b>m</b> = 48</p>																								
[Description]	Encodes and prints the QR Code symbol data in the symbol storage area using the process of <Function 180>.																								
[Notes]	<ul style="list-style-type: none"> <li>■ In standard mode, use this function when printer is "at the beginning of a line," or "there is no data in the print buffer."</li> <li>■ The symbol size that exceeds the print area cannot be printed.</li> <li>■ If there is any error described below in the data of the symbol storage area, it cannot be printed.             <ul style="list-style-type: none"> <li>• There is no data (Function 180 is not processed).</li> <li>• If the data of the symbol storage area is more than the data allowed by specified model and data compaction mode. (This case is an abnormal number of data.)</li> <li>• The four data compaction modes are listed below (in order of compaction rate). Automatically selects best compaction mode by the data of the symbol storage area.                 <ul style="list-style-type: none"> <li>– Numerical mode</li> <li>– Alphanumeric mode</li> <li>– Kanji mode</li> <li>– 8-Bit Byte Mode</li> </ul> </li> </ul> </li> <li>■ The following data are added automatically by the encode processing.             <ul style="list-style-type: none"> <li>• Position Detection Patterns</li> <li>• Separators for Position Detection Patterns</li> <li>• Timing Patterns</li> </ul> </li> </ul>																								

- Format Information
  - Version Information
  - Error Correction codewords (employs the Reed-Solomon Error Detection and Correction algorithm)
  - Pad codeword
  - Number of bits in Character Count Indicator
  - Mode Indicator
  - Terminator
  - Alignment Patterns (when model 2 is selected)
  - Extension Patterns (when model 1 is selected)
- Printing of symbol is not affected by print mode (emphasized, double-strike, underline, white/ black reverse printing, or 90° clockwise-rotated), except for character size and upside-down print mode.
  - In standard mode, this command executes paper feeding for the amount needed for printing the symbol, regardless of the paper feed amount set by the paper feed setting command. The print position returns to the left side of the printable area after printing the symbol, and printer is in the status "beginning of the line," or "there is no data in the print buffer."
  - In page mode, the printer stores the symbol data in the print buffer without executing actual printing. The printer moves print position to the next dot of the last data of the symbol.
  - The quiet zone is not included in the printing data. Be sure to include the quiet zone when using this function.

[Model-dependent variations]

**TM-T90, TM-T88IV, TM-T70, TM-L90, TM-P60**

## **TM-T90**

**This model does not support this Function.**

## **TM-T88IV, TM-T70, TM-L90**

**When printing a QR Code symbol, the printer starts actual printing after it reaches control speed for printing the symbols. The paper must be fed 10 dots or less in this operation. This area is not included in the vertical area transmitted by Function 182.**



## **TM-P60**

**TM-P60 with peeler supports this function.**

**When printing QR Code symbol, it is printed with the “printing control mode = fine” regardless of the setting of Function 48 of GS ( K.**

## GS ( k <Function 182>

[Name] QR Code: Transmit the size information of the symbol data in the symbol storage area

[Format]

ASCII	GS (	k	<b>pL</b>	<b>pH</b>	<b>cn</b>	<b>fn</b>	<b>m</b>
Hex	1D 28 6B	<b>03</b>	<b>00</b>	<b>31</b>	<b>52</b>	<b>m</b>	
Decimal	29 40 107	<b>3</b>	<b>0</b>	<b>49</b>	<b>82</b>	<b>m</b>	

[Range]  $(pL + pH \times 256) = 3$  (**pL** = 3, **pH** = 0)  
**cn** = 49  
**fn** = 82  
**m** = 48

[Description] Transmits the size information for the encoded QR Code symbol data in the symbol storage area using the process of <Function 180>.

- [Notes]
- In standard mode, use this function when the printer is "at the beginning of a line," or "there is no data in the print buffer."
  - The size information for each data is as follows;

Send data	Hex	Decimal	Data
Header	37H	55	1 byte
Identifier	36H	54	1 byte
Horizontal size(*1)	30H –39H	48 –57	1 –5 byte
Separator	1FH	31	1 byte
Vertical size(*1)	30H –39H	48 –57	1 –5 byte
Separator	1FH	31	1 byte
Fixed value	31H	49	1 byte
Separator	1FH	31	1 byte
Other information(*2)	30H or 31H	48 or 49	1 byte
NUL	00H	0	1 byte

(\*1)“Horizontal size” and “vertical size” indicate the number of dots of the symbol.

The decimal value of the vertical size and horizontal size is converted to text data and sent starting from the high order end.

(ex: When horizontal size is 120 dots, horizontal size is “120” (in hexadecimal: 31H, 32H, and 30H / in decimal: 49, 50, and 48 ), which is 3 bytes of data.)

(\*2)“Other information” indicates whether printing of the data in the symbol storage area is possible or impossible. The “Other information” is the following.

### Other information

Hex	Decimal	Condition
30H	48	Printing is possible
31H	49	Printing is impossible

- Size information indicates size of symbol that is printed by Function 181.
- The quiet zone is not included in the size information.
- If “other information” is “Printing is impossible”(in decimal: 49), use one of the solutions shown below.

Cause	Solution
There are data in the print buffer in the standard mode	Put the printer in the “there is no data in the print buffer” status by executing <b>GS T</b> or print commands ( <b>LF, CR, ESC J</b> ).
Symbol is bigger than the current print area.	Expand the print area by <b>GS W, ESC W, ESC \$</b> . Reduce the module size by Function 167. Lower the error correction level by Function 169.
The data in the symbol storage area is too large.	Send correct data by Function 180. Select other model by Function 165 Lower the error correction level by Function 169.
There is no data in the symbol storage area.	Send data to the symbol storage area by Function 180.

# CONFIDENTIAL

- See previous [Notes for transmission process] for process sending data group.

[Model-dependent variations]      **TM-T90, TM-P60**

## **TM-T90**

**This model does not support this function.**

## **TM-P60**

**TM-P60 with peeler supports this function.**

## GS ( k <Function 265>

---

[Name] MaxiCode: Select the mode

[Format] ASCII GS ( k **pl** **ph** **cn** **fn** **n**  
 Hex 1D 28 6B **03** **00** **32** **41** **n**  
 Decimal 29 40 107 **3** **0** **50** **65** **n**

[Range]  $(pl + ph \times 256) = 3$  (**pl** =3, **ph** =0)  
**cn** = 50  
**fn** = 65  
 $50 \leq n \leq 54$

[Default] **n** = 50

[Description] Selects the mode for the MaxiCode

n	Function
50	Selects mode 2.
51	Selects mode 3.
52	Selects mode 4.
53	Selects mode 5.
54	Selects mode 6.

- [Notes]
- Settings of this function affect the processing of Functions 281 and 282.
  - Settings of this function are effective until **ESC @** is executed, the printer is reset, or the power is turned off.

[Model-dependent variations] **TM-T90**, **TM-T88IV**, **TM-T70**, **TM-P60**

**TM-T90**, **TM-T88IV**, **TM-T70**

This model does not support this function.

**TM-P60**

**TM-P60 with peeler supports this function.**

## GS ( k <Function 280>

---

[Name]	MaxiCode: Store the data in the symbol storage area																											
[Format]	<table border="0"> <tr> <td>ASCII</td> <td>GS (</td> <td>k</td> <td><b>pL</b></td> <td><b>pH</b></td> <td><b>cn</b></td> <td><b>fn</b></td> <td><b>m</b></td> <td><b>d1...dk</b></td> </tr> <tr> <td>Hex</td> <td>1D 28</td> <td>6B</td> <td><b>pL</b></td> <td><b>pH</b></td> <td><b>32</b></td> <td><b>50</b></td> <td><b>30</b></td> <td><b>d1...dk</b></td> </tr> <tr> <td>Decimal</td> <td>29 40</td> <td>107</td> <td><b>pL</b></td> <td><b>pH</b></td> <td><b>50</b></td> <td><b>80</b></td> <td><b>48</b></td> <td><b>d1...dk</b></td> </tr> </table>	ASCII	GS (	k	<b>pL</b>	<b>pH</b>	<b>cn</b>	<b>fn</b>	<b>m</b>	<b>d1...dk</b>	Hex	1D 28	6B	<b>pL</b>	<b>pH</b>	<b>32</b>	<b>50</b>	<b>30</b>	<b>d1...dk</b>	Decimal	29 40	107	<b>pL</b>	<b>pH</b>	<b>50</b>	<b>80</b>	<b>48</b>	<b>d1...dk</b>
ASCII	GS (	k	<b>pL</b>	<b>pH</b>	<b>cn</b>	<b>fn</b>	<b>m</b>	<b>d1...dk</b>																				
Hex	1D 28	6B	<b>pL</b>	<b>pH</b>	<b>32</b>	<b>50</b>	<b>30</b>	<b>d1...dk</b>																				
Decimal	29 40	107	<b>pL</b>	<b>pH</b>	<b>50</b>	<b>80</b>	<b>48</b>	<b>d1...dk</b>																				
[Range]	$4 \leq (\mathbf{pL} + \mathbf{pH} \times 256) \leq 141$ ( $4 \leq \mathbf{pL} \leq 141, 0 \leq \mathbf{pH} \leq 0$ ) $\mathbf{cn} = 50$ $\mathbf{fn} = 80$ $\mathbf{m} = 48$ $0 \leq \mathbf{d} \leq 255$ $\mathbf{k} = (\mathbf{pL} + \mathbf{pH} \times 256) - 3$																											
[Description]	Stores the MaxiCode symbol data ( <b>d1...dk</b> ) in the symbol storage area.																											
[Notes]	<ul style="list-style-type: none"> <li>■ The symbol data saved in the symbol archive area by this function is encoded by &lt;Function 081&gt; and &lt;Function 082&gt; of this command. After &lt;Function 081&gt; and &lt;Function 082&gt; are executed, the symbol archive area symbol data is kept.</li> <li>■ <b>k</b> bytes of <b>d1...dk</b> are processed as the symbol data.</li> <li>■ Settings of this function are effective until the following processing is performed: <ul style="list-style-type: none"> <li>• Function 080 or 180 or 280 or 380 or 480 is executed</li> <li>• <b>ESC @</b> is executed</li> <li>• The printer is reset or the power is turned off</li> </ul> </li> </ul>																											
[Model-dependent variations]	<b>TM-T90, TM-T88IV, TM-T70, TM-P60</b>																											

### **TM-T90, TM-T88IV, TM-T70**

This model does not support this function.

### **TM-P60**

**TM-P60 with peeler supports this function.**

## GS ( k <Function 281>

---

[Name] MaxiCode: Print the symbol data in the symbol storage area

[Format] ASCII GS ( k **PL PH CN FN M**  
 Hex 1D 28 6B **03 00 32 51 m**  
 Decimal 29 40 107 **3 0 50 81 m**

[Range]  $(\mathbf{PL} + \mathbf{PH} \times 256) = 3$  ( $\mathbf{PL} = 3, \mathbf{PH} = 0$ )  
**CN** = 50  
**FN** = 81  
**M** = 48

[Description] Encodes and prints the MaxiCode symbol data in the symbol storage area using the process of <Function 280>.

- [Notes]
- In standard mode, use this function when printer is "at the beginning of a line," or "there is no data in the print buffer."
  - If the symbol size exceeds the print area, the symbol cannot be printed.
  - If there is any error described below in the data of the symbol storage area, it cannot be printed.
    - There is no data (Function 180 is not processed).
    - When using only numeric characters, the data is more than 138 characters.
    - When using alphanumeric characters, the data is more than 93 characters.
    - When Mode 2 is selected, the Primary Message includes all data except the following.

Factor of Primary Message	Number of data	Character
Postal code	1 ~ 9 byte	Numeric
ISO country code	1 ~ 3 byte	Numeric
Class of service code	1 ~ 3 byte	Numeric

- When mode 3 is selected, the Primary Message includes all data except the following.

Factor of Primary Message	Number of data	Character
Postal code	1 ~ 6 byte	Code set A
ISO country code	1 ~ 3 byte	Numeric
Class of service code	1 ~ 3 byte	Numeric

- When using Mode 2 or 3, execute the process as listed below:  
(**RS**, **GS** indicates control code of MaxiCode (**RS** = 1EH, **GS** = 1DH). "**yy**" indicates numeric data of 2 byte.)
  - a) When the top of symbol data is "[ ]>" **RS** "01" **GS** "**yy**", these 9 bytes of data are treated as header
    - Next data of the header is treated as Primary Message.
    - When printing, header is set to top of Secondary Message.
  - b) When the top of symbol data is not "[ ]>" **RS** "01" **GS** "**yy**", the data is treated as Primary Message.
  - c) In Primary Message, **GS** separate message into Postal code and ISO country code and Class of service. This **GS** is disregarded.
  - d) In Primary Message, it does not check each code.  
(ex: specified Postal code and correct Postal code. etc.)
  - e) All data of Secondary message is treated as symbol data. (In Secondary Message, **GS** is treated as symbol data.)
- In mode 4, 5 and 6, all of the data in the symbol storage area is treated as Primary Message and Secondary Message. It does not check each code.
- MaxiCode employs the Reed-Solomon Error Detection and Correction algorithm for error correction codeword.
- The following data are added automatically by the encode processing.
  - Finder Pattern
  - Orientation Pattern
  - Error correction codewords
  - Mode indicator
  - Pad codeword



- Printing of symbol is not affected by print mode (emphasized, double-strike, underline, white/ black reverse printing, or 90° clockwise-rotated), except for character size and upside-down print mode.
- In standard mode, this command executes paper feeding for the amount needed for printing the symbol, regardless of the paper feed amount set by the paper feed setting command. The print position returns to the left side of the printable area after printing the symbol, and printer is in the status "beginning of the line," or "there is no data in the print buffer."
- In page mode, the printer stores the symbol data in the print buffer without executing actual printing. The printer moves print position to the next dot of the last data of the symbol.
- The quiet zone is not included in the printing data. Be sure to secure the quiet zone when using this function.

[Model-dependent variations]

**TM-T90, TM-T88IV, TM-T70, TM-L90, TM-P60**

**TM-T90, TM-T88IV, TM-T70**

**This model does not support this function.**

**TM-L90**

**When printing MaxiCode symbols, the printer starts actual printing after it reaches the control speed for printing symbols. It is needed to feed paper amount of 10 dots or less in this operation. This area is not included in the vertical area transmitted by Function 282.**

**TM-P60**

**TM-P60 with peeler supports this function.**

**MaxiCode symbols are printed with the "printing control mode = fine" regardless of the setting of Function 48 of GS ( K.**

## GS ( k <Function 282>

[Name] MaxiCode: Transmit the size information of the symbol data in the symbol storage area

[Format]

ASCII	GS (	k	<b>pL</b>	<b>pH</b>	<b>cn</b>	<b>fn</b>	<b>m</b>
Hex	1D 28	6B	<b>03</b>	<b>00</b>	<b>32</b>	<b>52</b>	<b>m</b>
Decimal	29 40	107	<b>3</b>	<b>0</b>	<b>50</b>	<b>82</b>	<b>m</b>

[Range]  $(pL + pH \times 256) = 3$  (**pL** = 3, **pH** = 0)  
**cn** = 50  
**fn** = 82  
**m** = 48

[Description] Transmits the size information for the encoded MaxiCode symbol data in the symbol storage area using the process of <Function 280>.

- [Notes]
- In standard mode, use this function when the printer is "at the beginning of a line," or "there is no data in the print buffer."
  - The size information for each data is as follows;

Send data	Hex	Decimal	Data
Header	37H	55	1 byte
Identifier	37H	55	1 byte
Horizontal size(*1)	30H –39H	48 –57	1 –5 byte
Separator	1FH	31	1 byte
Vertical size(*1)	30H –39H	48 –57	1 –5 byte
Separator	1FH	31	1 byte
Fixed value	31H	49	1 byte
Separator	1FH	31	1 byte
Other information(*2)	30H or 31H	48 or 49	1 byte
NUL	00H	0	1 byte

(\*1)“Horizontal size” and “vertical size” indicate the number of dots of the symbol.

The decimal value of the vertical size and horizontal size is converted to text data and sent starting from the high order end.

(ex: When horizontal size is 120 dots, horizontal size is “120” (in hexadecimal: 31H, 32H, and 30H / in decimal: 49, 50, and 48 ), which is 3 bytes of data.)

(\*2)“Other information” indicates whether printing of the data in the symbol storage area is possible or impossible. The “Other information” is the following.

### Other information

Hex	Decimal	Condition
30H	48	Printing is possible
31H	49	Printing is impossible

- Size information indicates size of symbol that is printed by Function 281.
- The quiet zone is not included in the size information.
- If “other information” cannot be printed, use one of the solutions shown below.

Cause	Solution
There are data in the print buffer in the standard mode.	Put the printer in the state “there is no data in the print buffer” by executing <b>GS T</b> or print commands ( <b>LF, CR, ESC J</b> ).
Symbol is bigger than the current print area.	Expand the print area. (by <b>GS W, ESC W, ESC \$</b> etc.)
When mode 2 or 3 is selected, incorrect data exists in Primary Message.	Send correct data by Function 280.
The data in the symbol storage area is too large.	Send correct data by Function 280.
There is no data in the symbol storage area.	Send data to the symbol storage area by Function 280.

- See previous [Notes for transmission process] for process sending data group.

# CONFIDENTIAL

[Model-dependent variations]

**TM-T90, TM-T88IV, TM-T70, TM-P60**

**TM-T90, TM-T88IV, TM-T70**

This model does not support this function.

**TM-P60**

**TM-P60 with peeler supports this function.**

## GS ( k <Function 367>

---

[Name]	RSS: Set the width of the module									
[Format]	ASCII	GS (	k	<b>pL</b>	<b>pH</b>	<b>cn</b>	<b>fn</b>	<b>n</b>		
	Hex	1D 28	6B	<b>03</b>	<b>00</b>	<b>33</b>	<b>43</b>	<b>n</b>		
	Decimal	29 40	107	<b>3</b>	<b>0</b>	<b>51</b>	<b>67</b>	<b>n</b>		
[Range]	<b>(pL + pH × 256) = 3 (pL =3, pH =0)</b> <b>cn = 51</b> <b>fn = 67</b> <b>TM-P60: 2 ≤ n ≤ 8</b>									
[Default]	<b>TM-P60: n = 2</b>									
[Description]	Sets the width of the module for RSS to <b>n</b> dots.									
[Notes]	<ul style="list-style-type: none"> <li>■ Settings of this function affect the processing of Functions 381 and 382.</li> <li>■ Settings of this function are effective until <b>ESC @</b> is executed, the printer is reset, or the power is turned off.</li> </ul>									
[Model-dependent variations]	<b>TM-T90, TM-T88IV, TM-T70, TM-L90, TM-P60</b>									

### **TM-T90, TM-T88IV, TM-T70, TM-L90**

**This model does not support this function.**

### **TM-P60**

**TM-P60 with peeler supports this function.**

**The setting unit is 1 dot. The width is set in units of 0.125 mm {1/203 inch}.**

## GS ( k <Function 371>

---

[Name] 2-dimensional RSS: RSS Expanded Stacked maximum width setting

[Format]

ASCII	GS (	k	<b>pL</b>	<b>pH</b>	<b>cn</b>	<b>fn</b>	<b>n</b>
Hex	1D 28	6B	<b>03</b>	<b>00</b>	<b>33</b>	<b>43</b>	<b>n</b>
Decimal	29 40	107	<b>3</b>	<b>0</b>	<b>51</b>	<b>67</b>	<b>n</b>

[Range] **(pL + pH × 256) = 3 (pL =3, pH =0)**  
**cn = 51**  
**fn = 67**  
**TM-P60: 2 ≤ n ≤ 8**

[Default] **TM-P60: n = 2**

[Description] Sets the width of the module for RSS to **n** dots.

- [Notes]
- Settings of this function affect the processing of Functions 381 and 382.
  - When  $(nL + nH \times 256) = 0$  is specified, the width of the symbol changes according to the printing area when <Function 381> and <Function 382> are processed.
  - Settings of this function are effective until **ESC @** is executed, the printer is reset, or the power is turned off.

[Model-dependent variations] **TM-T90, TM-T88IV, TM-T70, TM-L90, TM-P60**

**TM-T90, TM-T88IV, TM-T70, TM-L90**

**This model does not support this function.**

### TM-P60

**TM-P60 with peeler supports this function.**

**The setting unit is 1 dot. The width is set in units of 0.125 mm {1/203 inch}.**

## GS ( k <Function 380>

[Name] 2-dimensional RSS: Store the data in the symbol storage area

[Format] ASCII GS ( k **pl pH cn fn m n d1...dk**  
 Hex 1D 28 6B **pl pH 33 50 30 n d1...dk**  
 Decimal 29 40 107 **pl pH 51 80 48 n d1...dk**

[Range]  $6 \leq (\mathbf{pl} + \mathbf{pH} \times 256) \leq 259$  ( $0 \leq \mathbf{pl} \leq 255, \mathbf{pH} = 0, 1$ )  
**cn** = 51  
**fn** = 80  
**m** = 48  
**n** = 72, 73, 76  
**k** =  $(\mathbf{pl} + \mathbf{pH} \times 256) - 4$

The domain of (d) differs with the type of 2-dimensional RSS. Refer to the [Function] table.

[Description] The 2-dimensional RSS symbol data (**d1...dk**) specified by n is saved in the symbol archive area.

m	2-dimensional RSS	Symbol data (SP indicates a space)		
		Data (k)	Characters (ASCII)	Data (d)
72	RSS-14 Stacked	<b>k</b> = 13	"0"~"9"	$48 \leq \mathbf{d} \leq 57$
73	RSS-14 Stacked Omnidirectional	<b>k</b> = 13	"0"~"9"	$48 \leq \mathbf{d} \leq 57$ [However d1 = 48,49]
76	RSS Expanded Stacked	<b>k</b> = 13	0~`9, A~`D, a~`d SP, !, ", %, \$, ', (, ), *, +, ,, -, ., /, :, ;, <, =, >, ?, _ , {	$48 \leq \mathbf{d} \leq 57, 65 \leq \mathbf{d} \leq 90, 97 \leq \mathbf{d} \leq 122,$ $32 \leq \mathbf{d} \leq 34, 37 \leq \mathbf{d} \leq 47, 58 \leq \mathbf{d} \leq 63,$ <b>d</b> = 95,123 [However <b>d1</b> = 40, $48 \leq \mathbf{d2} \leq 57, 48 \leq \mathbf{d3} \leq 57$ , $48 \leq \mathbf{d1} \leq 57, 48 \leq \mathbf{d2} \leq 57$ ]

- [Notes]
- Data stored in the symbol storage area by this function is processed by Functions 381 and 382. The data in the symbol storage area are reserved after processing Function 381 or 382.
  - **k** bytes of **d1...dk** are processed as symbol data.
  - Settings of this function are effective until the following processing is performed:

# CONFIDENTIAL

- Function 080 or 180 or 280 or 380 or 480 is executed
- **ESC @** is executed
- The printer is reset or the power is turned off

[Description: Applied to RSS-14 Stacked and RSS-14 Stacked Omnidirectional]

- Transmit the 13-digit product identification number, excluding the application identifier (AI) and check digit, from the host.

[Description: Applied to RSS Stacked]

- Transmit the 2-byte data shown in the following table ([Hexadecimal = 7BH / Decimal = 123] + character code) from the host for the special character (FNC1) and symbol data "(", ")". ("+" in the table is not included in the transmission data).

Data	Transmission data from host		
	ASCII	Hexadecimal	Decimal
FNC1	{ + 1	7B + 31	123 + 49
(	{ + (	7B + 28	123 + 40
)	{ + )	7B + 29	123 + 41

[Model-dependent variations]

**TM-T90, TM-T88IV, TM-T70, TM-L90, TM-P60**

**TM-T90, TM-T88IV, TM-T70, TM-L90**

**This model does not support this function.**

**TM-P60**

**TM-P60 with peeler supports this function.**



## GS ( k <Function 381>

---

[Name] 2-dimensional RSS: Print the symbol data in the symbol storage area

[Format]

ASCII	GS (	k	<b>pL</b>	<b>pH</b>	<b>cn</b>	<b>fn</b>	<b>m</b>
Hex	1D 28	6B	<b>03</b>	<b>00</b>	<b>33</b>	<b>51</b>	<b>30</b>
Decimal	29 40	107	<b>3</b>	<b>0</b>	<b>51</b>	<b>81</b>	<b>48</b>

[Range] (**pL** + **pH** × 256) = 3 (**pL** = 3, **pH** = 0)  
**cn** = 51  
**fn** = 81  
**m** = 48

[Description] Encodes and prints the RSS symbol data in the symbol storage area using the process of <Function 380>.

- [Notes]
- In standard mode, use this function when printer is “at the beginning of a line,” or “there is no data in the print buffer.”
  - The symbol size that exceeds the print area cannot be printed.
  - If there is any error described below in the data of the symbol storage area, it cannot be printed.
    - There is no data (Function 380 is not processed).
    - When there is a problem with the amount of data saved in the symbol archive area.
    - When the data saved in the symbol archive area includes data outside the domain.
  - Printing of symbol is not affected by print mode (emphasized, double-strike, underline, white/ black reverse printing, or 90° clockwise-rotated), except for character size and upside-down print mode.
  - In standard mode, this command executes paper feeding for the amount needed for printing the symbol, regardless of the paper feed amount set by the paper feed setting command. The print position returns to the left side of the printable area after printing the symbol, and printer is in the status “beginning of the line,” or “there is no data in the print buffer.”
  - In page mode, the printer stores the symbol data in the print buffer without executing actual printing. The printer moves print position to the next dot of the last data of the symbol.
  - The quiet zone is not included in the printing data. Be sure to include the quiet zone when using this function.

# CONFIDENTIAL

[Description: Applied to RSS-14 Stacked and RSS-14 Stacked Omnidirectional]

- The data shown below is added automatically in encoding.
  - Application identifier (AI): The AI is "01".
  - Check digit (1 character)
  - Guard pattern and separator pattern

[Note for RSS Expanded Stacked]

- The data shown below is added automatically in encoding.
  - Guard pattern, finder pattern and separator pattern
- For encoding, the width of the symbol is decided by the setting value of <Function 371> of this command ( $nL + nH \times 256$ ) and the current printing area (the area from the current printing position to the edge of the printing area).
  - When  $(nL + nH \times 256) = 0$ , the width of the symbol is the current printing area.
  - When  $(nL + nH \times 256) \neq 0$  is specified and the setting value is greater than the current printing area, the width of the symbol is the current printing area.
  - In cases other than above,  $(nL + nH \times 256)$  is the width of the symbol.

[Model-dependent variations]

**TM-T90, TM-T88IV, TM-T70, TM-L90, TM-P60**

**TM-T90, TM-T88IV, TM-T70, TM-L90**

**This model does not support this Function.**

**TM-P60**

**TM-P60 with peeler supports this function.**

**In standard mode, symbols with height greater than 1,200 dots cannot be printed with this printer. 2-dimensional RSS symbols are printed with the "printing control mode = fine" regardless of the setting of Function 48 of GS ( K.**

## GS ( k <Function 382>

[Name] 2-dimensional RSS: Transmit the size information of the symbol data in the symbol storage area

[Format]

ASCII	GS (	k	<b>pL</b>	<b>pH</b>	<b>cn</b>	<b>fn</b>	<b>m</b>
Hex	1D 28 6B	<b>03</b>	<b>00</b>	<b>33</b>	<b>52</b>	<b>30</b>	
Decimal	29 40 107	<b>3</b>	<b>0</b>	<b>51</b>	<b>82</b>	<b>48</b>	

[Range]  $(pL + pH \times 256) = 3$  (**pL** = 3, **pH** = 0)  
**cn** = 51  
**fn** = 82  
**m** = 48

[Description] Transmits the size information for the encoded 2-dimensional RSS symbol data in the symbol storage area using the process of <Function 380>.

- [Notes]
- In standard mode, use this function when the printer is "at the beginning of a line," or "there is no data in the print buffer."
  - Size information of this command shows the size of the symbol which is printed with <Function 381>.
  - The size information for each data is as follows:

Send data	Hex	Decimal	Data
Header	37H	55	1 byte
Identifier	4FH	79	1 byte
Horizontal size(*1)	30H –39H	48 –57	1 –5 byte
Separator	1FH	31	1 byte
Vertical size(*1)	30H –39H	48 –57	1 –5 byte
Separator	1FH	31	1 byte
Fixed value	31H	49	1 byte

Send data	Hex	Decimal	Data
Separator	1FH	31	1 byte
Other information(*2)	30H or 31H	48 or 49	1 byte
NUL	00H	0	1 byte

(\*1)“Horizontal size” and “vertical size” indicate the number of dots of the symbol.

The decimal value of the vertical size and horizontal size is converted to text data and sent starting from the high order end.

(ex: When horizontal size is 120 dots, horizontal size is “120” (in hexadecimal: 31H, 32H, and 30H / in decimal: 49, 50, and 48 ), which is 3 bytes of data.)

(\*2)“Other information” indicates whether printing of the data in the symbol storage area is possible or impossible. The “Other information” is the following.

### Other information

Hex	Decimal	Condition
30H	48	Printing is possible
31H	49	Printing is impossible

- Size information indicates size of symbol that is printed by Function 181.
- The quiet zone is not included in the size information.

- If “other information” is “Printing is impossible”(in decimal: 49), use one of the solutions shown below.

Cause	Solution
There are data in the print buffer in the standard mode	Put the printer in the “there is no data in the print buffer” status by executing <b>GS T</b> or print commands ( <b>LF, CR, ESC J</b> ).
Symbol is bigger than the current print area.	Expand the print area by <b>GS W, ESC W, ESC \$</b> . Reduce the module width by Function 367.
There is a problem with the amount of data or with the data of the symbol data	Send correct data by Function 380.
There is no data in the symbol storage area.	Send data to the symbol storage area by Function 380.

- See previous [Notes for transmission process] for process sending data group.

[Model-dependent variations]      **TM-T90, TM-T88IV, TM-T70, TM-L90, TM-P60**

**TM-T90, TM-T88IV, TM-T70, TM-L90**

**This model does not support this function.**

**TM-P60**

**TM-P60 with peeler supports this function.**

**In standard mode, when symbols have a height greater than 1,200 dots, they cannot be printed with this printer according to [Other information] [Hexadecimal = 31H/Decimal = 49].**

## GS ( k <Function 467>

---

[Name] Composite Symbol: Set the width of the module

[Format]	ASCII	GS (	k	<b>pL</b>	<b>pH</b>	<b>cn</b>	<b>fn</b>	<b>n</b>
	Hex	1D 28	6B	<b>03</b>	<b>00</b>	<b>34</b>	<b>43</b>	<b>n</b>
	Decimal	29 40	107	<b>3</b>	<b>0</b>	<b>52</b>	<b>67</b>	<b>n</b>

[Range] **(pL + pH × 256) = 3 (pL =3, pH =0)**  
**cn = 52**  
**fn = 67**  
**TM-P60: 2 ≤ n ≤ 8**

[Default] **TM-P60: n = 2**

[Description] Sets the width of the module for Composite Symbol to **n** dots.

- Sets the module width of the line element, 2D composite element, and separator.

[Notes] ■ Settings of this function affect the processing of Functions 481 and 482.

■ Settings of this function are effective until **ESC @** is executed, the printer is reset, or the power is turned off.

[Model-dependent variations] **TM-T90, TM-T88IV, TM-T70, TM-L90, TM-P60**

**TM-T90, TM-T88IV, TM-T70, TM-L90**

**This model does not support this function.**

**TM-P60**

**TM-P60 with peeler supports this function.**

**The setting unit is 1 dot. The width is set in units of 0.125 mm {1/203 inch}.**

## GS ( k <Function 471>

---

[Name]	Composite Symbol: RSS Expanded Stacked maximum width setting								
[Format]	ASCII	GS (	k	<b>pL</b>	<b>pH</b>	<b>cn</b>	<b>fn</b>	<b>n</b>	
	Hex	1D 28	6B	<b>03</b>	<b>00</b>	<b>34</b>	<b>43</b>	<b>n</b>	
	Decimal	29 40	107	<b>3</b>	<b>0</b>	<b>52</b>	<b>67</b>	<b>n</b>	
[Range]	<b>(pL + pH × 256) = 3 (pL =3, pH =0)</b> <b>cn = 52</b> <b>fn = 67</b> <b>TM-P60: 2 ≤ n ≤ 8</b>								
[Default]	<b>TM-P60: n = 2</b>								
[Description]	Sets the maximum width of the RSS Expanded Stacked (composite symbol line element) to (nL + nH x 256) dots. <ul style="list-style-type: none"> <li>• When (nL + nH x 256) = 0, maximum width does not set.</li> <li>■ Settings of this function affect the processing of Functions 481 and 482.</li> <li>■ When (nL + nH x 256) = 0 is specified, the width of the symbol changes according to the printing area when &lt;Function 381&gt; and &lt;Function 382&gt; are processed.</li> <li>■ Settings of this function are effective until <b>ESC @</b> is executed, the printer is reset, or the power is turned off.</li> </ul>								
[Model-dependent variations]	<b>TM-T90, TM-T88IV, TM-T70, TM-L90, TM-P60</b>								

### **TM-T90, TM-T88IV, TM-T70, TM-L90**

**This model does not support this function.**

### **TM-P60**

**TM-P60 with peeler supports this function.**

**The setting unit is 1 dot. The width is set in units of 0.125 mm {1/203 inch}.**

## GS ( k <Function 472>

[Name] Composite Symbol: Select font HRI characters

[Format] ASCII GS ( **k** **pL** **pH** **cn** **fn** **n**  
 Hex 1D 28 6B 03 00 34 48 **n**  
 Decimal 29 40 107 3 0 52 72 **n**

[Range]  $(pL + pH \times 256) = 3$  (**pL** =3, **pH** =0)  
**cn** = 52  
**fn** = 72  
**TM-P60:  $0 \leq n \leq 3, 48 \leq n \leq 51$**

[Default] **n** = 0

[Printers not featuring this command] **TM-U230**, **TM-U220**

[Description] Selects a font for the Human Readable Interpretation (HRI) characters when printing Composite Symbol, using **n** as follows:

<b>n</b>	<b>Font of HRI characters</b>
0, 48	HRI characters are not added.
1, 49	HRI characters are added. (Select Font A)
2, 50	HRI characters are added. (Select Font B)
3, 51	HRI characters are added. (Select Font C)

The character structure of each font depends on the model.

- [Notes]
- The settings of this function affect the processing of <Function 481> and <Function 482> of this command.
  - When "Add HRI characters" is selected, HRI characters are added to the bottom of the 1-dimensional system line element.
  - HRI characters are not added to the 2-dimensional system line element (RSS-14 Stacked, RSS-14 Stacked Omnidirectional, RSS Expanded Stacked), without reference to the setting of this function.
  - The setting of this function is valid until **ESC @**, reset, or power off are executed.



# CONFIDENTIAL

- HRI characters are characters (Human Readable Interpretation) that indicate the content of the line element of the composite symbol printed using the composite symbol.

[Model-dependent variations]      **TM-T90, TM-T88IV, TM-T70, TM-L90, TM-P60**

**TM-T90, TM-T88IV, TM-T70, TM-L90**

**This model does not support this function.**

**TM-P60**

**TM-P60 with peeler supports this function.**

**Font constitution: Font A (12 × 24)**

**Font B (10 × 24)**

**Font C (8 × 16)**

## GS ( k <Function 480>

- [Name] Composite Symbol: Store the data in the symbol storage area
- [Format]
- |         |           |   |           |           |           |           |           |          |          |                |
|---------|-----------|---|-----------|-----------|-----------|-----------|-----------|----------|----------|----------------|
| ASCII   | GS (      | k | <b>pL</b> | <b>pH</b> | <b>cn</b> | <b>fn</b> | <b>m</b>  | <b>a</b> | <b>b</b> | <b>d1...dk</b> |
| Hex     | 1D 28 6B  |   | <b>pL</b> | <b>pH</b> | <b>33</b> | <b>50</b> | <b>30</b> | <b>a</b> | <b>b</b> | <b>d1...dk</b> |
| Decimal | 29 40 107 |   | <b>pL</b> | <b>pH</b> | <b>51</b> | <b>80</b> | <b>48</b> | <b>a</b> | <b>b</b> | <b>d1...dk</b> |
- [Range]
- $6 \leq (\mathbf{pL} + \mathbf{pH} \times 256) \leq 2366$  ( $0 \leq \mathbf{pL} \leq 255$ ,  $\mathbf{pH} = 9$ )
- cn** = 52
- fn** = 80
- m** = 48
- a** = 48, 49
- $65 \leq \mathbf{b} \leq 77$  [ when (a = 48)]
- b** = 65, 66 [ when (a = 49)]
- k** =  $(\mathbf{pL} + \mathbf{pH} \times 256) - 5$
- The domain of (d) differs with the type of line element and 2D composite element. Refer to the [Function] table.
- [Description] The composite symbol data (**d1...dk**) is saved in the symbol archive area.
- When (a = 48), b specifies the type of line element.

<b>m</b>	<b>Line element type</b>	<b>Symbol data (SP indicates a space)</b>		
		<b>Data (k)</b>	<b>Characters (ASCII)</b>	<b>Data (d)</b>
65	EAN8	<b>k</b> = 7	"0" ~ "9"	$48 \leq \mathbf{d} \leq 57$
66	EAN13	<b>k</b> = 12	"0" ~ "9"	$48 \leq \mathbf{d} \leq 57$
67	UPC-A	<b>k</b> = 11	"0" ~ "9"	$48 \leq \mathbf{d} \leq 57$
68	UPC-E (Abbreviated 0 [6 digits] Version)	<b>k</b> = 6	"0" ~ "9"	$48 \leq \mathbf{d} \leq 57$

<b>m</b>	<b>Line element type</b>	<b>Symbol data (SP indicates a space)</b>		
		<b>Data (k)</b>	<b>Characters (ASCII)</b>	<b>Data (d)</b>
69	UPC-E (No abbreviation 0 (11 Digits) Version)	$k = 11$	"0" ~ ` "9"	$48 \leq d \leq 57$ [However $d1 = 48,49$ ]
70	RSS-14	$k = 13$	"0" ~ ` "9"	$48 \leq d \leq 57$
71	RSS-14 Truncated	$k = 13$	"0" ~ "9"	$48 \leq d \leq 57$
72	RSS-14 Stacked	$k = 13$	"0" ~ "9"	$48 \leq d \leq 57$
73	RSS-14 Stacked Omnidirectional	$k = 13$	"0" ~ ` "9"	$48 \leq d \leq 57$ [However $d1 = 48,49$ ]
74	RSS-14 Limited	$k = 13$	"0" ~ ` "9"	$48 \leq d \leq 57$ [However $d1 = 48,49$ ]
75	RSS-14 Expanded	$2 \leq k \leq 255$	"0" ~ ` "9"	$48 \leq d \leq 57$ [However $d1 = 48,49$ ]
76	RSS Expanded Stacked	$2 \leq k \leq 255$	0~`9, A~`D, a~`d SP, !, ", %, \$, ', (, ), *, +, ,, -, ., /, :, ;, <, =, >, ?, _ {	$48 \leq d \leq 57, 65 \leq d \leq 90, 97 \leq d \leq 122,$ $32 \leq d \leq 34, 37 \leq d \leq 47, 58 \leq d \leq 63,$ $d = 95,123$ [However $d1 = 40, 48 \leq d2 \leq 57, 48 \leq d3 \leq 57$ , $48 \leq d1 \leq 57, 48 \leq d2 \leq 57$ ]
77	UCC/EAN 128	$2 \leq k \leq 255$	NUL ~ SP (7FH)	$0 \leq d \leq 127$

- When (a = 49), b specifies the type of 2D composite element.

<b>b</b>	<b>2D composite element type</b>	<b>Symbol data (SP indicates a space)</b>		
		<b>Data (k)</b>	<b>Characters (ASCII)</b>	<b>Data (d)</b>
65	EAN13	$1 \leq k \leq 2361$	NUL ~ SP (7FH)	$0 \leq d \leq 255$
66	UPC-A	$1 \leq k \leq 2361$	NUL ~ SP (7FH)	$0 \leq d \leq 255$

[Notes] ■ Data stored in the symbol storage area by this function is processed by Functions 481 and 482. The data in the symbol storage area are reserved after processing Function 481 or 482.

- **k** bytes of **d1...dk** are processed as symbol data.
- To print a composite symbol, this function must be executed twice.
  - Specify (a = 48), and save the line element symbol data.
  - Specify (a = 49), and save the 2D composite element symbol data.
  - It does not matter whether the line element (a = 48) or 2D composite element (a = 49) is specified first.
  - It is possible to change the symbol data of the 2D composite element (a = 49) without changing that of the line element (a = 48), and vice versa.
- The line element symbol data in the symbol archive area is valid until any of <Function 080>, <Function 180>, <Function 280>, <Function 380>, and <Function 480: when (a = 48) is specified> of this command, ESC @, reset, or power off are executed.
- The 2D composite element symbol data in the symbol archive area is valid until any of <Function 080>, <Function 180>, <Function 280>, <Function 380>, and <Function 480: when (a = 49) is specified> of this command, ESC @, reset, or power off are executed.

[Notes for EAN8, EAN13, and UPC-A]

- Transmit the data, except for the modular check character, from the host.

[Notes for UPC-E (0 omitted (6 digits) version)]

- Transmit the data, except for the number system character (NSC) and modular check character, from the host.

[Notes for UPC-E (0 not omitted (11 digits) version)]

- Transmit the data except for the modular check character from the host.
- The first data (d1) is processed as a number system character (NSC). Always specify 0.

[Notes for RSS-14, RSS-14 Truncated, RSS-14 Stacked, RSS-14 Stacked Omnidirectional, and RSS Limited]

- Transmit the 13-digit product identification number, excluding the application identifier (AI) and check digit, from the host.

# CONFIDENTIAL

[Notes for RSS Expanded]

- Transmit the 2-byte data shown in the following table ([Hexadecimal = 7BH / Decimal = 123] + character code) from the host for the special character (FNC1) and symbol data "(", ")". ("+" in the table is not included in the transmission data)]

Data	Transmission data from host		
	ASCII	Hexadecimal	Decimal
FNC1	{ + 1	7B + 31	123 + 49
(	{ + (	7B + 28	123 + 40
)	{ + )	7B + 29	123 + 41

- The special characters ("(", ")") have the functions shown in the table below.

Special characters			
Characters	Hexadecimal	Decimal	Functions
(	28	40	Each character is inserted for the HRI character. It makes the HRI characters look nice when used to enclose the AI. The data does not constitute encoded data.
)	29	41	

Notes for RSS Expanded Stacked]

- Transmit the 2-byte data shown in the following table ([Hexadecimal = 7BH / Decimal = 123] + character code) from the host for the special character (FNC1) and symbol data "(", ")". ("+" in the table is not included in the transmission data)

Data	Transmission data from host		
	ASCII	Hexadecimal	Decimal
FNC1	{ + 1	7B + 31	123 + 49
(	{ + (	7B + 28	123 + 40
)	{ + )	7B + 29	123 + 41

# CONFIDENTIAL

Notes for UCC/EAN 128]

[Description: Applied to UCC/EAN128 (**m** = 74)]

- UCC/EAN128 processes the following structures.

(a) Basic structure

Start character	FNC 1	AI	Data part	Check digit A	Check digit B	Stop character
Automatically added	<b>(d1...dk)</b>			Automatically added		

(b) Concatenated code structure

Start character	FNC 1	AI	Data part	Check digit A	FNC 1	AI	Data part	Check digit A	Check digit B	Stop character
Automatically added	<b>(d1...dk)</b>							Automatically added		

- The 4 special characters (SP, "(", " "), " \*") are processed as shown in the table below.

<b>Special characters</b>			
<b>Character</b>	<b>Hex</b>	<b>Decimal</b>	<b>Functions</b>
SP	20	32	A space is inserted for the HRI character. It makes the HRI characters look nice when AI and data part are separated with spaces. SP does not constitute encoded data.
(	28	40	Each character is inserted to make the HRI characters look nice when used to enclose the AI. The data does not constitute encoded data.
)	29	41	
*	2A	42	Check digit A (1 character), calculated with modulus 10 is added as the data part at the position of *. "*" is not an HRI character, but check digits are inserted for HRI characters.

- Examples of symbol data using special characters (SP, "(", " "), " \*") are shown below.

Example: When [AI = 01/data = 9501234567890/Specify to add check digit A/enclose AI in ()]

GS k 23 0 52 80 48 48 77 "(01)9501234567890\*"

When HRI characters are designated to be added, the HRI characters are [(01)95012345678903].

Example: When [AI = 01/data = 9501234567890/Specify to add check digit A/enclose AI in (), and insert a space between the data]

GS k 23 0 52 80 48 48 77 "(01)9501234567890\* "

When HRI characters are designated to be added, the HRI characters are [(01)95012345678903].

Example: When linking [AI = 01/data = 9501234567890/Specify to add check digit A/enclose AI in ()] and [AI=3102/data = 000400/enclose AI in ()], and separating the HRI characters between the link with a space

GS k 38 0 52 80 48 77"(01)9501234567890\* {1(3102)000400"

When HRI characters are designated to be added, the HRI characters are [(01)95012345678903 (3102)000400].

# CONFIDENTIAL

- The range of data (d) that can be processed in each code set (CODE A, CODE B, CODE C) is shown in the table below. Data where the character field is diagonal cannot be used. Transmit the 2-byte data shown in the following table ([Hexadecimal = 7BH / Decimal = 123] + character code) from the host for the special characters (FNC1, FNC3) and symbol data (" ", ")", "\*", "{".

d		Character		
Hex	Decimal	CODE A	CODE B	CODE C
00	0	NUL		00
01	1	SOH		01
02	2	STX		02
03	3	ETX		03
04	4	EOT		04
05	5	ENQ		05
06	6	ACK		06
07	7	BEL		07
08	8	BS		08
09	9	HT		09
0A	10	LF		10
0B	11	VT		11
0C	12	FF		12
0D	13	CR		13
0E	14	SO		14
0F	15	SI		15
10	16	DLE		16
11	17	DC1		17
12	18	DC2		18
13	19	DC3		19
14	20	DC4		20
15	21	NAK		21
16	22	SYN		22
17	23	ETB		23
18	24	CAN		24
19	25	EM		25
1A	26	SUB		26
1B	27	ESC		27
1C	28	FS		28
1D	29	GS		29
1E	30	RS		30
1F	31	US		31
20	32			
21	33	!	!	33
22	34	"	"	34
23	35	#	#	35
24	36	\$	\$	36

d		Character		
Hex	Decimal	CODE A	CODE B	CODE C
25	37	%	%	37
26	38	&	&	38
27	39	'	'	39
7B, 28	123, 40	(	(	40
7B, 29	123, 41	)	)	41
7B, 2A	123, 42	=	=	42
2B	43	+	+	43
2C	44	,	,	44
2D	45	-	-	45
2E	46	.	.	46
2F	47	/	/	47
30	48	0	0	48
31	49	1	1	49
32	50	2	2	50
33	51	3	3	51
34	52	4	4	52
35	53	5	5	53
36	54	6	6	54
37	55	7	7	55
38	56	8	8	56
39	57	9	9	57
3A	58	:	:	58
3B	59	;	;	59
3C	60	<	<	60
3D	61	=	=	61
3E	62	>	>	62
3F	63	?	?	63
40	64	@	@	64
41	65	A	A	65
42	66	B	B	66
43	67	C	C	67
44	68	D	D	68
45	69	E	E	69
46	70	F	F	70
47	71	G	G	71
48	72	H	H	72
49	73	I	I	73

d		Character		
Hex	Decimal	CODE A	CODE B	CODE C
4A	74	J	J	74
4B	75	K	K	75
4C	76	L	L	76
4D	77	M	M	77
4E	78	N	N	78
4F	79	O	O	79
50	80	P	P	80
51	81	Q	Q	81
52	82	R	R	82
53	83	S	S	83
54	84	T	T	84
55	85	U	U	85
56	86	V	V	86
57	87	W	W	87
58	88	X	X	88
59	89	Y	Y	89
5A	90	Z	Z	90
5B	91	[	[	91
5C	92	\	\	92
5D	93	]	]	93
5E	94	^	^	94
5F	95	_	_	95
60	96	`	`	96
61	97	a	a	97
62	98	b	b	98
63	99	c	c	99
64	100	d	d	
65	101	e	e	
66	102	f	f	
67	103	g	g	
68	104	h	h	
69	105	i	i	
6A	106	j	j	
6B	107	k	k	
6C	108	l	l	
6D	109	m	m	
6E	110	n	n	

d		Character		
Hex	Decimal	CODE A	CODE B	CODE C
6F	111		o	
70	112		p	
71	113		q	
72	114		r	
73	115		s	
74	116		t	
75	117		u	
76	118		v	
77	119		w	
78	120		x	
79	121		y	
7A	122		z	
7B, 7B	123, 123		{	
7C	124			
7D	125		}	
7E	126		~	
7F	127		DEL	

d		Special Character		
Hex	Decimal	CODE A	CODE B	CODE C
7B, 31	123, 49	FNC1	FNC1	FNC1
7B, 33	123, 51	FNC3	FNC3	
20	32	SP	SP	SP
28	40	(	(	(
29	41	)	)	)
2A	42	*	*	*

[Notes for 2D composite elements]

- When automatic selection (b = 65) is specified, the type of 2D composite element is decided according to the amount of data (k).

Data (k)	1 ~ 56	57 ~ 338	339 ~ 2361
2D composite element	CC - A	CC - B	CC - C



- When CC-C is selected for the 2D composite element with any of the following, specify UCC/EAN128 for the line element.
  - When "Fixed (CC-C)" is specified with (b = 66)
  - When (b = 65) is specified, and the amount of data exceeds 339 bytes

[Model-dependent variations]      **TM-T90, TM-T88IV, TM-T70, TM-L90, TM-P60**

**TM-T90, TM-T88IV, TM-T70, TM-L90**

**This model does not support this function.**

**TM-P60**

**TM-P60 with peeler supports this function.**

## GS ( k <Function 481>

---

[Name] Composite Symbol: Print the symbol data in the symbol storage area

[Format]

ASCII	GS (	k	<b>pL</b>	<b>pH</b>	<b>cn</b>	<b>fn</b>	<b>m</b>
Hex	1D 28	6B	<b>03</b>	<b>00</b>	<b>34</b>	<b>51</b>	<b>30</b>
Decimal	29 40	107	<b>3</b>	<b>0</b>	<b>52</b>	<b>81</b>	<b>48</b>

[Range]  $(\mathbf{pL} + \mathbf{pH} \times 256) = 3$  ( $\mathbf{pL} = 3$ ,  $\mathbf{pH} = 0$ )  
**cn** = 52  
**fn** = 81  
**m** = 48

[Description] Encodes and prints the RSS symbol data in the symbol storage area using the process of <Function 480>.

- [Notes]
- In standard mode, use this function when printer is "at the beginning of a line," or "there is no data in the print buffer."
  - The symbol size that exceeds the print area cannot be printed.
  - If there is any error described below in the data of the symbol storage area, it cannot be printed.
    - There is no data (Function 380 is not processed).
    - When there is a problem with the amount of data saved in the symbol archive area.
    - When the data saved in the symbol archive area includes data outside the domain.
    - When there is a problem with the combination of the line element and 2D composite element
  - Printing of symbol is not affected by print mode (emphasized, double-strike, underline, white/ black reverse printing, or 90° clockwise-rotated), except for character size and upside-down print mode.
  - In standard mode, this command executes paper feeding for the amount needed for printing the symbol, regardless of the paper feed amount set by the paper feed setting command. The print position returns to the left side of the printable area after printing the symbol, and printer is in the status "beginning of the line," or "there is no data in the print buffer."
  - In page mode, the printer stores the symbol data in the print buffer without executing actual printing. The printer moves print position to the next dot of the last data of the symbol.
  - Automatically adds a separator to the line element and 2D composite element.

- The quiet zone is not included in the printing data. Be sure to include the quiet zone when using this function.

[Notes for EAN8, EAN13, and UPC-A]

- The data shown below is added automatically in encoding.
- Modular check character (1 character)
- Guard bar

[Notes for UPC-E (0 omitted [6 digit] version)]

- Calculates the modular check character automatically. The modular check character is data for deciding the bar pattern, and is not included in the print data.
- Adds the guard bar automatically for encoding.

[Notes for UPC-E (0 not omitted [11 digit] version)]

- Calculates the modular check character automatically. The modular check character is data for deciding the bar pattern, and is not included in the print data.
- A shortened 6-digit code (D1 to D6) generated from the (**d2...d11**) data in accordance with the table below is printed.

Data of transmitted by host PC										Printing data					
<i>d2</i>	<i>d3</i>	<i>d4</i>	<i>d5</i>	<i>d6</i>	<i>d7</i>	<i>d8</i>	<i>d9</i>	<i>d10</i>	<i>d11</i>	<i>D1</i>	<i>D2</i>	<i>D3</i>	<i>D4</i>	<i>D5</i>	<i>D6</i>
0 ~ 9	0 ~ 9	0	0	0	-	-	0 ~ 9	0 ~ 9	0 ~ 9	<i>d2</i>	<i>d3</i>	<i>d9</i>	<i>d10</i>	<i>d11</i>	0
0 ~ 9	0 ~ 9	1	0	0	-	-	0 ~ 9	0 ~ 9	0 ~ 9	<i>d2</i>	<i>d3</i>	<i>d9</i>	<i>d10</i>	<i>d11</i>	1
0 ~ 9	0 ~ 9	2	0	0	-	-	0 ~ 9	0 ~ 9	0 ~ 9	<i>d2</i>	<i>d3</i>	<i>d9</i>	<i>d10</i>	<i>d11</i>	2
0 ~ 9	0 ~ 9	3 ~ 9	0	0	-	-	-	0 ~ 9	0 ~ 9	<i>d2</i>	<i>d3</i>	<i>d4</i>	<i>d10</i>	<i>d11</i>	3
0 ~ 9	0 ~ 9	0 ~ 9	1 ~ 9	0	-	-	-	-	0 ~ 9	<i>d2</i>	<i>d3</i>	<i>d4</i>	<i>d5</i>	<i>d11</i>	4
0 ~ 9	0 ~ 9	0 ~ 9	0 ~ 9	1 ~ 9	-	-	-	-	5 ~ 9	<i>d2</i>	<i>d3</i>	<i>d4</i>	<i>d5</i>	<i>d6</i>	<i>d11</i>

- Specify 0 at indicated data by "-" in the table.
- When  $1 \leq \mathbf{d6} \leq 9$ , be sure to specify ( $5 \leq \mathbf{d11} \leq 9$ ).
- Adds the guard bar automatically for encoding.

[Note for RSS Expanded]

- The data shown below is added automatically in encoding.
  - Guard pattern and finder pattern
- The special characters ("(", ")") are processed as shown in the table below.

<b>Special characters</b>			
<b>Character</b>	<b>Hex</b>	<b>Decimal</b>	<b>Processing</b>
(	28	40	"(" is inserted for the HRI character. "(" does not constitute encoded data.
)	29	41	"(" is inserted for the HRI character. "(" does not constitute encoded data.

- Adds the guard pattern and finder pattern automatically.
- When HRI characters are designated to be added, special character HRI characters are processed as follows.
  - The HRI character of function character (FNC1) is not printed.
  - The HRI characters of special characters ("(", ")") are printed as the respective characters ("(", ")").
  - The HRI characters of bar code data [{" + ("(", ")")}] are printed as the respective characters ("(", ")").

[Note for RSS Expanded Stacked]

- The data shown below is added automatically in encoding.
  - Guard pattern, finder pattern and separator pattern
- For encoding, the width of the symbol is decided by the setting value of <Function 471> of this command (nL + nH x 256) and the current printing area (the area from the current printing position to the edge of the printing area).
  - When (nL + nH = 256) = 0, the width of the symbol is the current printing area.
  - When (nL + nH 256) ≠ 0 is specified and the setting value is greater than the current printing area, the width of the symbol is the current printing area.
  - In cases other than above, (nL + nH x 256) is the width of the symbol.

- Even when HRI characters are designated to be added, HRI characters are not added to this symbol.

[Note for UCC/EAN128]

- UCC/EAN128 processes the following structures.

(a) Basic structure

Start character	FNC 1	AI	Data part	Check digit A	Check digit B	Stop character
Automatically added		<Function 480 ( <b>d1...dn</b> )>			Automatically added	

(b) Concatenated code structure

Start character	FNC 1	AI	Data part	Check digit A	FNC 1	AI	Data part	Check digit A	Check digit B	Stop character
Automatically added		<Function 480 ( <b>d1...dn</b> )>							Automatically added	

- The data shown below is added automatically in encoding.

- Start character (CODE A, CODE B, CODE C) and FNC1
- Check digit B (1 character)
- Stop character

- The 4 special characters (SP, "(", " "), " (\*)") are processed as shown in the table below.

Special characters			
Character	Hex	Decimal	Processing
SP	20	32	After <b>d1</b> , the first SP is processed as AI and the data part delimiter, and a space is inserted for the HRI characters. Spaces are inserted for the HRI characters for subsequent SP. These spaces do not constitute encoded data.

(	28	40	"(" is inserted for the HRI character. "(" does not constitute encoded data.
)	29	41	After <b>d1</b> , the first ")" is processed as AI and the data part delimiter, and ")" is inserted for the HRI characters. ")" are inserted for the HRI characters for subsequent ")". In case of any, "(" does not constitute encoded data.
*	2A	42	Check digit A (1 character), calculated with modulus 10 is added as the data part at the position of *. "*" is not an HRI character, but check digits are inserted for HRI characters.

- The HRI characters of special characters are processed as follows. ("SP" indicates a space)
  - The HRI character of the start character (CODE A, CODE B, CODE C) is not printed.
  - The HRI characters of the function characters (FNC1, FNC3) and the control characters (Hexadecimal = 00H - 1FH, 7FH / Decimal = 0 - 31, 127) are printed as spaces.
  - The HRI characters of special characters (SP, "(, " ")") are printed as the respective characters (SP, "(, " ")").
  - The HRI character of special character ("\*") prints a check digit.
  - The HRI characters of bar code data [{"{"+"(, " "), " "\*," "{"}]} are printed as the respective characters ("(, " "), " "\*," "{"}
- The HRI characters of bar code data [{"{"+"(, " "), " "\*," "{"}]} are printed as the respective characters ("(, " "), " "\*," "{"}

[Model-dependent variations]

**TM-T90, TM-T88IV, TM-T70, TM-L90, TM-P60**

**TM-T90, TM-T88IV, TM-T70, TM-L90**

**This model does not support this Function.**

## TM-P60

**TM-P60 with peeler supports this function.**

**In standard mode, symbols with height greater than 1,200 dots cannot be printed with this printer.**

**Composite symbols are printed with the “printing control mode = fine” regardless of the setting of Function 48 of GS ( K.**

## GS ( k <Function 482>

[Name] Composite Symbol: Transmit the size information of the symbol data in the symbol storage area

[Format]

ASCII	GS (	k	<b>pL</b>	<b>pH</b>	<b>cn</b>	<b>fn</b>	<b>m</b>
Hex	1D 28	6B	<b>03</b>	<b>00</b>	<b>34</b>	<b>52</b>	<b>30</b>
Decimal	29 40	107	<b>3</b>	<b>0</b>	<b>52</b>	<b>82</b>	<b>48</b>

[Range]  $(pL + pH \times 256) = 3$  (**pL** = 3, **pH** = 0)  
**cn** = 52  
**fn** = 82  
**m** = 48

[Description] Transmits the size information for the encoded Composite symbol data in the symbol storage area using the process of <Function 481>.

- [Notes]
- In standard mode, use this function when the printer is "at the beginning of a line," or "there is no data in the print buffer."
  - Size information is the size of the symbol that is printed by <Function 481> of this command, and is the sum of the following data.
    - Line element and 2D composite element
    - Line element and 2D composite element separator
    - When HRI characters are designated to be added, the height of the HRI characters and the space between the symbol and HRI characters
  - The size information for each data is as follows;

Send data	Hex	Decimal	Data
Header	37H	55	1 byte
Identifier	50FH	80	1 byte
Horizontal size(*1)	30H –39H	48 –57	1 –5 byte
Separator	1FH	31	1 byte
Vertical size(*1)	30H –39H	48 –57	1 –5 byte



Send data	Hex	Decimal	Data
Separator	1FH	31	1 byte
Fixed value	31H	49	1 byte
Separator	1FH	31	1 byte
Other information(*2)	30H or 31H	48 or 49	1 byte
Error information(*3)	30H or 39H	48 or 57	4 byte
NUL	00H	0	1 byte

(\*1)“Horizontal size” and “vertical size” indicate the number of dots of the symbol.

The decimal value of the vertical size and horizontal size is converted to text data and sent starting from the high order end.

(ex: When horizontal size is 120 dots, horizontal size is “120” (in hexadecimal: 31H, 32H, and 30H / in decimal: 49, 50, and 48 ), which is 3 bytes of data.)

(\*2)“Other information” indicates whether printing of the data in the symbol storage area is possible or impossible. The “Other information” is the following.

### Other information

Hex	Decimal	Condition
30H	48	Printing is possible
31H	49	Printing is impossible

(\*3)[Error information] indicates mainly detailed information when [Other information] is [Unprintable].

<b>Error information</b>	<b>Error content</b>	<b>Solution</b>
"0000"	No error (printing is possible)	-
"1001"	The line element symbol data is invalid	Transmit valid data (Function 480)
"1002"	The 2D composite element symbol data is invalid	Transmit valid data (Function 480)
"1003"	There is too much 2D composite element data When something other than UCC/EAN128 is specified for line element, and when "automatic selection" is specified for 2D composite element and the 2D composite element data exceeds 399 bytes	Reduce the amount of 2D composite element data (Function 480) Change the line element to UCC/EAN 128 (Function 480)
"1005"	The combination of line element and 2D composite element is invalid When something other than UCC/EAN128 is specified for line element, and "Fixed (CC-C)" is specified for the 2D composite element	Change the line element to UCC/EAN 128 (Function 480) Change the 2D composite element to "automatic selection" (when the amount of data is 338 bytes or less) (Function 480)
"1006"	There is no data in the symbol archive area	Transmit data (Function 480)
"2001"	When the standard mode is selected, there is data in the print buffer	Empty the print buffer (GS T or the print command [LF, CR, ESC J, etc.])
"2002"	The symbol size is bigger than the current printing area The symbol is bigger than the printing area The symbol is bigger than the <Function 471> maximum width	Make the module size smaller (Function 467) Make the <Function 471> maximum width bigger Make the printing area bigger (GS W, ESC W, ESC \$ etc)

- The quiet zone is not included in the size information.

# CONFIDENTIAL

- See previous [Notes for transmission process] for process sending data group.

[Model-dependent variations]

**TM-T90, TM-T88IV, TM-T70, TM-L90, TM-P60**

**TM-T90, TM-T88IV, TM-T70, TM-L90**

**This model does not support this function.**

**TM-P60**

**TM-P60 with peeler supports this function.**

**In standard mode, when symbols have a height greater than 1,200 dots, they cannot be printed with this printer according to [Other information] [Hexadecimal = 31H/Decimal = 49]. In this case the [Error information] is "2002".**

## CUSTOMIZE COMMANDS

Command	Name
---------	------

<b>FS g 1</b>	Write to NV user memory
<b>FS g 2</b>	Read from NV user memory
<b>GS ( C</b>	Edit NV user memory
	Delete the specified record
	Store the data in the specified record
	Transmit the data in the specified record
	Transmit capacity of the NV user memory currently being used
	Transmit the remaining capacity of the NV user memory
	Transmit the key code list
	Delete all data in the NV user memory
<b>GS ( E</b>	Set user setup commands
	Change into the user setting mode
	End the user setting mode session
	Change the memory switch
	Transmit the settings of the memory switch
	Set the customized setting values
	Transmit the customized setting values
	Copy the user-defined page
	Define the data (column format) for the character code page
	Define the data (raster format) for the character code page
	Delete the data for the character code page
	Set the configuration item for the serial interface
	Transmit the configuration item for the serial interface
	Set the configuration item for the Bluetooth interface
	Transmit the configuration item for the Bluetooth interface
	Delete the paper layout
	Set the paper layout

## **GS ( M**

Transmit the paper layout information

Customize printer control value(s)

Save the setting values from the work area into the storage area

Load the setting values stored in the storage area to the work area

Select the setting values loaded to the work area after the initialization process

## FS g 1

[Name]	Write to NV user memory						
[Format]	ASCII	FS	g	1	<b>m</b>	<b>a1 a2 a3 a4</b>	<b>nL nH d1...dk</b>
	Hex	1C	67	31	<b>m</b>	<b>a1 a2 a3 a4</b>	<b>nL nH d1...dk</b>
	Decimal	28	103	49	<b>m</b>	<b>a1 a2 a3 a4</b>	<b>nL nH d1...dk</b>

[Printers not featuring this command] **TM-J2000/J2100**, **TM-T90**, **TM-T70**, **TM-L90**, **TM-P60**, **TM-U230**, **TM-U220**

[Range] **TM-T88IV : m = 0**  
 $0 \leq (\mathbf{a1} + \mathbf{a2} \times 256) + \mathbf{a3} \times 65536) + (\mathbf{a4} \times 16777216) \leq 1023$   
 $1 \leq (\mathbf{nL} + \mathbf{nH} \times 256) \leq 1024$   
 $32 \leq \mathbf{d} \leq 255$   
 $\mathbf{k} = (\mathbf{nL} + \mathbf{nH} \times 256)$   
**The definition area is 1 KB**

[Description] Stores the data to NV user memory.

- **a1**, **a2**, **a3**, and **a4** specify the stored data starting address as  $(\mathbf{a1} + \mathbf{a2} \times 256 + \mathbf{a3} \times 65536 + \mathbf{a4} \times 16777216)$ .
- **nL** and **nH** specifies the number of stored data bytes  $(\mathbf{nL} + \mathbf{nH} \times 256)$ .
- **d** specifies the stored data.
- **k** indicates the number of stored data. **k** is an explanation parameter; therefore, it does not need to be transmitted.

[Recommended Functions]

- This is an unrecommended command. It is supported by some printer models but will not be supported by future models.
- **GS ( C** is recommended to write to NV user memory. Operation of **GS ( C** offers the following improvements:
  - Data can be controlled by the record.
  - Each record can be redefined, retrieved, or deleted by keycode.
  - Memory can be used efficiently because the printer controls the data.
  - The amount of definition area remaining can be confirmed.

- [Notes]
- NV user memory is the memory area used for storing character font data in non-volatile memory. The data stored is effective until it is redefined by this command.
  - In standard mode, this command is effective only when processed at the beginning of a line.
  - If this command is encountered while a macro is being defined, the printer cancels macro definition and starts processing this command. At that time, the macro becomes undefined.
  - All the previously stored data in the specified area is replaced with new data.
  - The NV user memory data can be read by **FS g 2**.
  - Data is written to non-volatile memory by this function. Note the following when using these functions:
    - Do not turn off the power or reset the printer from the interface when this command is being executed.
    - The printer may be BUSY when storing data and will not receive any data. In this case, be sure not to transmit data from the host.
    - Excessive use of this function may destroy the non-volatile memory. As a guideline, do not use any combination of the following commands more than 10 times per day for writing data to the non-volatile memory: **GS ( A** (part of functions), **GS ( C** (part of functions), **GS ( E** (part of functions), **GS ( L / GS 8 L** (part of functions), **GS ( M** (part of functions), **GS g 0**, **FS g 1**, **FS q**.
  - Note the rules below for the operating NV memory (store data / cancel data):
    - Even if the paper feed button is pressed, the printer does not feed paper.
    - The printer does not process real-time commands.
    - Even if "ASB is enabled" is specified, the printer does not send ASB status.

[Model-dependent variations]          None

### Program Example

```
PRINT #1, CHR$(&H1C); "g1"; CHR$(0);  
PRINT #1, CHR$(0); CHR$(0); CHR$(0); CHR$(0); CHR$(14); CHR$(0);  
PRINT #1, "NVimage1=Stamp";
```

## FS g 2

EXECUTING COMMAND

[Name] Read from NV user memory

[Format] ASCII FS g 2 **m a1 a2 a3 a4 nL nH**  
 Hex 1C 67 32 **m a1 a2 a3 a4 nL nH**  
 Decimal 28 103 50 **m a1 a2 a3 a4 nL nH**

[Printers not featuring this command] **TM-J2000/J2100, TM-T90, TM-T70, TM-L90, TM-P60, TM-U230, TM-U220**

[Range] **TM-T88IV: m = 0**  
 $0 \leq (a1 + a2 \times 256) \leq 1023$  ( $0 \leq a1 \leq 255, 0 \leq a2 \leq 3, a3 = 0, a4 = 0$ )  
 $1 \leq (nL + nH \times 256) \leq 80$  ( $0 \leq nL \leq 80, nH = 0$ )

[Description] Transmits the data in NV user memory.

- **a1, a2, a3,** and **a4** specify the starting address of transmission data as  $(a1 + a2 \times 256 + a3 \times 65536 + a4 \times 16777216)$ .
- **nL** and **nH** specify the amount of transmission data as  $(nL + nH \times 256)$  bytes.

[Recommended Functions]

- This is an unrecommended command. It is supported by some printer models but will not be supported by future models.
- **GS ( C** is recommended to write to NV user memory. Operation of **GS ( C** offers the following improvements:
  - Data can be controlled by record.
  - Each record can be redefined, retrieved, or deleted by keycode.
  - Memory can be used efficiently because the printer controls the data.
  - Transmission data can be identified.
  - The amount of definition area remaining can be confirmed.

[Notes] ■ NV user memory is the memory area used for storing character font data in non-volatile memory.



- Transmission data [Header + data + NUL] as follows is transmitted:

Transmitted data	Hex	Decimal	Amount of data
Header	5FH	95	1 byte
NV user memory data	20H ~ FEH	32 ~ 254	( <b>nL</b> + <b>nH</b> × 256) bytes
NULL	00H	0	1 byte

- Writing data to the NV user memory is enabled by **FS g 1**.
- When you use this function, obey the following rules.
  - When the host PC transmits the function data, transmit the next data after receiving the corresponding data (the header ~ NULL) from the printer
  - When operating with a serial interface, be sure to configure operation so that the host computer only uses the printer when it is READY.
  - With a parallel interface, a [Header to NUL] is stored first in the transmission buffer with the other transmission data (except for ASB status). When the host enters Reverse Mode, the data is transmitted in order from the beginning. Data that exceeds the transmission buffer (99 bytes) is ignored. When using the command, the host should enter Reverse Mode immediately and start processing the status.
- With serial interface, when communication with the printer uses XON/XOFF control, the XOFF code may interrupt the "Header to NUL" data string.
- User NV memory data can be identified to other transmission data according to specific data of the transmission data block. When the header transmitted by the printer is [Hex=5FH/Decimal=95], treat NUL [hex = 00H/decimal =0] as a data group and identify it according to the combination of the header.

### Program Example

```
PRINT #1, CHR$( &H1C ); "g2"; CHR$( 0 ); CHR$( 0 ); CHR$( 0 ); CHR$( 0 ); CHR$( 0 ); CHR$( 14 ); CHR$( 0 )
```

[Name] Edit NV user memory

[Printers not featuring this command] **TM-T88IV**, **TM-U230**

[Description] Edits the data in the NV user memory.

- Function code **fn** specifies the function.

<b>fn</b>	<b>Function No.</b>	<b>Function name</b>
0, 48	<b>Function 0</b>	Delete the specified record
1, 49	<b>Function 1</b>	Store the data in the specified record
2, 50	<b>Function 2</b>	Transmit the data in the specified record
3, 51	<b>Function 3</b>	Transmit capacity of the NV user memory currently being used
4, 52	<b>Function 4</b>	Transmit the remaining capacity of the NV user memory
5, 53	<b>Function 5</b>	Transmit the key code list
6, 54	<b>Function 6</b>	Delete all data in the NV user memory

- **pL**, **pH** specifies (**pL** + **pH** × 256) as the number of bytes after **pH** (**m**, **fn**, **b**, [**c1 c2**], and [**d1...dk**]).
- The other parameters are explained under each of the functions.

- [Notes]
- The command function is defined by the function code (**fn**). The command operation differs, depending on the function.
  - The NV user memory area is especially provided for storing character data in the non-volatile memory built into the printer.
  - The NV user memory data configuration is as follows: key code + data + terminator. This unit is called a record.
    - A record is one data processing unit in the NV user memory. It is controlled by a key code.
    - The key code is a 2-byte ID code used to identify records and is created with parameters **c1**, **c2** in the command (Character codes: Hexadecimal = 20H – 7EH/Decimal = 32 – 126.)

- Data is the character string specified by **d1... dk** in Function 1 of the **GS ( C** command. (Control codes: Hexadecimal = 00H – 1FH, 7FH/Decimal = 0 – 31, 127.)
- The terminator is a code, automatically assigned when the printer stores data.
- NV user memory data remains valid until the host sends a deletion or storage function command.
- Data is written to the non-volatile memory by Function 0, 1, or 6. When using those commands, note the following:
  - Do not turn off the power or reset the printer from the interface when the relevant functions are being executed.
  - The printer may be BUSY while the functions are performing. The printer does not process any received data while it is BUSY; therefore, under no circumstances should the host send data at this time.
  - Excessive use of this function may destroy the non-volatile memory. As a guideline, do not use any combination of the following commands more than 10 times per day for writing data in the non-volatile memory: **GS ( A**, **GS ( C**, **GS ( E**, **GS ( L / GS 8 L**, **GS ( M**, **GS g 0**, **FS g 1**, **FS q**.
- Note the rules below for the operating NV memory (store data / cancel data):
  - Even if the paper feed button is pressed, the printer does not feed paper.
  - The printer does not process real-time commands.
  - Even if “ASB is enabled” is specified, the printer does not send ASB status.
- You can use the NV user memory as an index of note for the following:
  - Customize information: index of the NV bit image definition contents, title of setting by **GS ( M**
  - Maintenance information: ink ribbon replacement date, telephone number of repair company, etc.

[Notes for transmitting processing of the block data]

- Data is sent by Function 2, 3, 4, or 5. When you use these functions, obey the following rules.
  - When the host PC transmits the function data, transmit the next data after receiving the corresponding data from the printer.
  - With serial interface printers, use this function when the host is READY.

- With a parallel interface printer, data sent (excluding ASB status) with this command (“Header to NUL”) is temporarily stored in the printer send buffer, as with other data. When the host goes into Reverse mode, the printer then sends the data sequentially from the beginning of the send buffer. Send buffer capacity is 99 bytes. Data exceeding this amount is lost. Therefore, when using this command, promptly change into Reverse mode to start the data receive process.
- When communication with the printer uses XON/XOFF control with serial interface, the XOFF code may interrupt the “Header to NUL” data string.
- The transmission information for each function can be identified to other transmission data according to specific data of the transmission data block. When the header transmitted by the printer is [hex = 37H/decimal =55], treat NUL [hex = 00H/decimal =0] as a data group and identify it according to the combination of the header and the identifier.

[Notes for ESC/POS Handshaking Protocol]

- Use ESC/POS Handshaking Protocol below for Functions 2 and 5:

Step	Host process	Printer process
1	Send <b>GS ( C &lt;Function 2&gt;</b> .	Start processing of Function 2. (Read specified record back to host.)
2	Receive data from printer.	Send data.
3	Send response code. <sup>(*1)</sup>	Continue processing <sup>(*2) (*3)</sup> according to response.

(\*1) Response code

ASCII	Hex	Decimal	Request
ACK	06	6	Send next data.
NAK	15	21	Resend previously sent data.
CAN	18	24	Cancel send process.

(\*2) Processing according to response (unsent data exists, identified by send data set "Identification status")

Response code	Process
ACK	Start send processing for next data.
NAK	Resend previously sent data.
CAN	End processing for this command.

■ Processing the codes except for ACK, NAK, and CAN performs the same processing as **CAN**.

(\*3) Processing according to response (no unsent data, identified by send data set "Identification status")

Response code	Process
ACK, CAN	End processing for this command.
NAK	Resend previously sent data.

### Program Example 1 (Write data for record \$1)

```
PRINT #1, CHR$( &H1D); " (C"; CHR$(18); CHR$(0); CHR$(0); CHR$(1); CHR$(0); "$1"; "EPSON ESC/POS"; " ←<Function 1>
```

### Program Example 2 (Read data for record %5)

```
PRINT #1, CHR$( &H1D); " (C"; CHR$(5); CHR$(0); CHR$(0); CHR$(2); CHR$(0); "%5"; " ←<Function 2>
*LOOP:
GOSUB *RECEIVE ← "Header to NUL" is received and stored under ST$ (details omitted)
PRINT #1, CHR$(6); ← Response code is sent
PRINT MID$(ST$,4) ← Record (%5) data is displayed on CRT
IF MID$(ST$,3,1)=CHR$(65) THEN *LOOP ← Check for any subsequent data
```

### Program Example 3 (Read available memory capacity)

```
PRINT #1, CHR$( &H1D); " (C"; CHR$(3); CHR$(0); CHR$(0); CHR$(4); CHR$(0); ←<Function 4>
GOSUB *RECEIVE ← "Header to NUL" is received and stored under ST$ (details omitted)
PRINT MID$(ST$,4) ← Available capacity is displayed on CRT
```

# CONFIDENTIAL

[Model-dependent variations]

**TM-J2000/J2100, TM-T90, TM-L90, TM-T70, TM-P60, TM-U220**

**TM-J2000/J2100, TM-P60**

Definition area of record data shares the same definition area with NV graphics memory (GS ( L)).  
Total record data is 384 KB.

**TM-T90, TM-L90**

Record data definition area capacity is selectable GS ( E <Function 5> as follows.

Selectable capacity	Default
1K, 64K, 128K, 192K	1K [units: byte]

**TM-T70**

Record data definition area capacity is 1 KB.

**TM-U220**

Record data definition area capacity is 8 KB.

## GS ( C *pL pH m fn b c1 c2* <Function 0>

---

[Name] Delete the specified record

[Format] ASCII GS ( C **pL pH m fn b c1 c2**  
Hex 1D 28 43 **05 00 00 fn 00 c1 c2**  
Decimal 29 40 67 **5 0 0 fn 0 c1 c2**

[Range] (**pL** + **pH** × 256) = 5 (**pL** = 5, **pH** = 0)  
**m** = 0  
**fn** = 0, 48  
**b** = 0  
32 ≤ **c1** ≤ 126  
32 ≤ **c2** ≤ 126

[Description] Deletes the record specified by the key codes (**c1**, **c2**) in the NV user memory.

- Deleted areas are designated "Unused areas."
- Deleted key codes are designated as undefined.

[Notes] ■ In standard mode, this command is valid only at the beginning of the line.

■ You cannot include macros with this command, so do not use this command while defining macros.

[Model-dependent variations] None

# CONFIDENTIAL

## **GS ( C *p<sub>L</sub>* *p<sub>H</sub>* *m* *fn* *b* *c1* *c2* *d1...dk* <Function 1>**

---

[Name] Store the data in the specified record

[Format] ASCII GS ( C **p<sub>L</sub>** **p<sub>H</sub>** **m** **fn** **b** **c1** **c2** **d1...dk**  
Hex 1D 28 43 **p<sub>L</sub>** **p<sub>H</sub>** **00** **fn** **00** **c1** **c2** **d1...dk**  
Decimal 29 40 67 **p<sub>L</sub>** **p<sub>H</sub>** **0** **fn** **0** **c1** **c2** **d1...dk**

[Range]  $6 \leq (\mathbf{p_L} + \mathbf{p_H} \times 256) \leq 65535$  ( $0 \leq \mathbf{p_L} \leq 255, 0 \leq \mathbf{p_H} \leq 255$ )

**m** = 0

**fn** = 1, 49

**b** = 0

$32 \leq \mathbf{c1} \leq 126$

$32 \leq \mathbf{c2} \leq 126$

$32 \leq \mathbf{d} \leq 254$

**k** =  $(\mathbf{p_L} + \mathbf{p_H} \times 256) - 5$

[Description] Stores the data (**d1... dk**) as the record specified by the key codes (**c1, c2**) in the NV user memory.

- When the specified record already exists, the data is overwritten.
- A terminator is automatically assigned.

[Notes] ■ In standard mode, this command is valid only at the beginning of the line.  
■ You cannot include macros with this command, so do not use this command while defining macros.  
■ You cannot use this command when the NV user memory does not have enough capacity to store the specified records. The available capacity is confirmed by Function 4.

[Model-dependent variations] **TM-J2000/J2100, TM-T90, TM-T70, TM-L90, TM-P60, TM-U220**

**TM-J2000/J2100, TM-T90, TM-T70, TM-L90, TM-U220**

**This function uses the “data quantity (k) + number of control information data (3 byte)” area for execution.**



## TM-P60

This function uses the "data quantity (**k**) + number of control information data" area for execution.

When data quantity (**k**) is odd number: number of control information data is 16 bytes.

When data quantity (**k**) is even number: number of control information data is 17 bytes.

## GS ( C *pL pH m fn b c1 c2* <Function 2>

[Name]	Transmit the data in the specified record										
[Format]	ASCII	GS (	C	<b>pL</b>	<b>pH</b>	<b>m</b>	<b>fn</b>	<b>b</b>	<b>c1</b>	<b>c2</b>	
	Hex	1D 28	43	<b>05</b>	<b>00</b>	<b>00</b>	<b>fn</b>	<b>00</b>	<b>c1</b>	<b>c2</b>	
	Decimal	29 40	67	<b>5</b>	<b>0</b>	<b>0</b>	<b>fn</b>	<b>0</b>	<b>c1</b>	<b>c2</b>	

[Range]  $(\mathbf{pL} + \mathbf{pH} \times 256) = 5$  ( $\mathbf{pL} = 5, \mathbf{pH} = 0$ )  
**m** = 0  
**fn** = 2, 50  
**b** = 0  
 $32 \leq \mathbf{c1} \leq 126$   
 $32 \leq \mathbf{c2} \leq 126$

[Description] Transmits the data for the record specified by the key codes (**c1**, **c2**) in the NV user memory.

- ESC/POS Handshaking Protocol is required for this function.

[Notes] ■ When the specified record exists, the printer sends the "Header to NUL" data shown below:

Send data	Hex	Decimal	Data quantity
Header	37H	55	1 byte
Identifier	70H	112	1 byte
Identification status <sup>(*1) (*2)</sup>	40H or 41H	64 or 65	1 byte
Data <sup>(*3)</sup>	20H –FEH	32 –254	1 –80 bytes
NUL	00H	0	1 byte

(\*1) When the quantity of stored data exceeds 80 bytes, the printer performs partial processing:

- If there is unsend data, the identification status of the third byte is 41H or 65 decimal.
- If there is no unsend data, the identification status of the third byte is 40H or 64 decimal.

(\*2) The printer performs batch processing when the data to be stored is 80 bytes or less. At this time, the identification status of the third byte is 40H or 64 decimal.

(\*3) The key code and terminator are not included in the data. If the stored data in the record is abnormal, it will be one-byte data of [Hexadecimal = FFH/Decimal = 255].

■ If the host specifies a nonexistent record, the printer sends the "Header to NUL" data shown below:

Send data	Hex	Decimal	Data quantity
Header	37H	55	1 byte
Identifier	70H	112	1 byte
Identification status	40H	64	1 byte
NUL	00H	0	1 byte

■ See [Notes for transmission process] for description of transmission process.

■ See [Notes for ESC/POS Handshaking Protocol] for description of ESC/POS Handshaking Protocol.

## GS ( C *p<sub>L</sub>* *p<sub>H</sub>* *m* *fn* *b* <Function 3>

[Name] Transmit capacity of the NV user memory currently being used

[Format]

ASCII	GS (	C	<b>p<sub>L</sub></b>	<b>p<sub>H</sub></b>	<b>m</b>	<b>fn</b>	<b>b</b>
Hex	1D 28 43	<b>03</b>	<b>00</b>	<b>00</b>	<b>fn</b>	<b>00</b>	
Decimal	29 40 67	<b>3</b>	<b>0</b>	<b>0</b>	<b>fn</b>	<b>0</b>	

[Range]  $(p_L + p_H \times 256) = 3$  ( $p_L = 3, p_H = 0$ )  
**m** = 0  
**fn** = 3, 51  
**b** = 0

[Description] Transmits the number of bytes of memory used in the NV user memory.

- ESC/POS Handshaking Protocol is not required for this function.

[Notes] ■ With this function, the printer sends the “Header to NUL” data shown below:

Send data	Hex	Decimal	Data quantity
Header	37H	55	1 byte
Identifier	28H	40	1 byte
Capacity Used <sup>(*1)</sup>	30H –39H	48 –57	1 –8 bytes
NUL	00H	0	1 byte

(\*1) The quantity of stored data bytes, plus the key code and terminator, equal the capacity being used. The decimal value expressing the capacity being used is converted to ASCII character data and sent from the most significant digit.

Example:

When 120 bytes is used, the number 120 is expressed with three bytes of data (Hexadecimal: 31H, 32H, and 30H / decimal numbers 49, 50, and 48).

When no memory area is used, the number 0 is expressed with 1 byte of data (Hexadecimal: 30H / decimal number 48).

- The control information for NV graphics data is included in the capacity in use.
- See previous [Notes for transmission process] for process sending data group.

## GS ( C *p<sub>L</sub>* *p<sub>H</sub>* *m* *fn* *b* <Function 4>

[Name] Transmit the remaining capacity of the NV user memory

[Format]

ASCII	GS (	C	<b>p<sub>L</sub></b>	<b>p<sub>H</sub></b>	<b>m</b>	<b>fn</b>	<b>b</b>
Hex	1D 28 43	<b>03</b>	<b>00</b>	<b>00</b>	<b>fn</b>	<b>00</b>	
Decimal	29 40 67	<b>3</b>	<b>0</b>	<b>0</b>	<b>fn</b>	<b>0</b>	

[Range] (**p<sub>L</sub>** + **p<sub>H</sub>** × 256) = 3 ( **p<sub>L</sub>** = 3, **p<sub>H</sub>** = 0)  
**m** = 0  
**fn** = 4, 52  
**b** = 0

[Description] Transmits the number of bytes of remaining memory (unused area) in the NV user memory.

- ESC/POS Handshaking Protocol is not required for this function.

[Notes] ■ With this function, the printer sends the “Header to NUL” data shown below:

Send data	Hex	Decimal	Data quantity
Header	37H	55	1 byte
Identifier	29H	41	1 byte
Available Capacity <sup>(*1)</sup>	30H –39H	48 –57	1 –8 bytes
NUL	00H	0	1 byte

(\*1) The available capacity indicates the number of bytes not being used. The decimal value for the available capacity is converted to ASCII character data and sent from the most significant digit.

Example: When 120 bytes is available (not being used), the number 120 is expressed with 3 bytes of data (Hexadecimal: 31H, 32H, and 30H / decimal numbers = 49, 50, and 48).

■ See previous [Notes for transmission process] for process sending data group.

# CONFIDENTIAL

## GS ( C *p<sub>L</sub>* *p<sub>H</sub>* *m* *fn* *b* <Function 5>

---

[Name]	Transmit the key code list								
[Format]	ASCII	GS	(	C	<b>p<sub>L</sub></b>	<b>p<sub>H</sub></b>	<b>m</b>	<b>fn</b>	<b>b</b>
	Hex	1D	28	43	<b>03</b>	<b>00</b>	<b>00</b>	<b>fn</b>	<b>00</b>
	Decimal	29	40	67	<b>3</b>	<b>0</b>	<b>0</b>	<b>fn</b>	<b>0</b>
[Range]	<b>(p<sub>L</sub> + p<sub>H</sub> × 256) = 3</b> ( <b>p<sub>L</sub> = 3, p<sub>H</sub> = 0</b> ) <b>m = 0</b> <b>fn = 5, 53</b> <b>b = 0</b>								
[Description]	Transmits the key code list in the NV user memory. <ul style="list-style-type: none"><li>• ESC/POS Handshaking Protocol is required for this function.</li></ul>								
[Notes]	■ When record exists, the printer sends the "Header to NUL" data as shown below:								

Send data	Hex	Decimal	Data quantity
Header	37H	55	1 byte
Identifier	71H	113	1 byte
Identification status <sup>(*1)</sup> <sup>(*2)</sup>	40H or 41H	64 or 65	1 byte
Data <sup>(*3)</sup>	20H –7EH	32 –126	2 –80 bytes
NUL	00H	0	1 byte

- (\*1) When the quantity of stored data exceeds 40 records, the printer performs partial processing:
- If there is unsent data, the identification status of the third byte is 41H or 65 decimal.
  - If there is no unsent data, the identification status of the third byte is 40H or 64 decimal.

(\*2) The printer performs batch processing when the data to be stored in the specified record is 40 records or less. At this time, the identification status of the third byte is 40H or 64 decimal.

(\*3) The data is the key code. A terminator is not included in the data.

■ If the host specifies a nonexistent record, the printer sends the “Header to NUL” data shown below:

Send data	Hex	Decimal	Data quantity
Header	37H	55	1 byte
Identifier	71H	113	1 byte
Identification status	40H	64	1 byte
NUL	00H	0	1 byte

■ See [Notes for transmission process] for description of transmission process.

■ See [Notes for ESC/POS Handshaking Protocol] for description of ESC/POS Handshaking Protocol.

## **GS ( C *pL pH m fn b d1 d2 d3* <Function 6>**

---

[Name] Delete all data in the NV user memory

[Format]

ASCII	GS (	C	<b>pL</b>	<b>pH</b>	<b>m</b>	<b>fn</b>	<b>b</b>	<b>d1</b>	<b>d2</b>	<b>d3</b>
Hex	1D 28 43	<b>06</b>	<b>00</b>	<b>00</b>	<b>fn</b>	<b>00</b>	<b>43</b>	<b>4C</b>	<b>52</b>	
Decimal	29 40 67	<b>6</b>	<b>0</b>	<b>0</b>	<b>fn</b>	<b>0</b>	<b>67</b>	<b>76</b>	<b>82</b>	

[Range] (**pL** + **pH** × 256) = 6    (**pL** = 6, **pH** = 0)  
**m** = 0  
**fn** = 6, 54  
**b** = 0  
**d1** = 67  
**d2** = 76  
**d3** = 82

[Description] Deletes all data in the NV user memory.

- All area is changed to unused area.
- All key codes are designated as undefined.

[Notes]

- In standard mode, this command is effective only at the beginning of the line.
- In page mode, this command is ignored.
- This command cannot include macros; therefore, do not use this command when defining macros.



[Name] Set user setup commands

[Printers not featuring this command] **TM-U230**

[Description] Controls the user setting modes. The table below explains the functions available in this command.

- Function code **fn** specifies the function.

<b>fn</b>	<b>Function No.</b>	<b>Function name</b>
1	<b>Function 1</b>	Change into the user setting mode.
2	<b>Function 2</b>	End the user setting mode session.
3	<b>Function 3</b>	Change the memory switch.
4	<b>Function 4</b>	Transmit the settings of the memory switch.
5	<b>Function 5</b>	Set the customized setting values.
6	<b>Function 6</b>	Transmit the customized setting values.
7	<b>Function 7</b>	Copy the user-defined page.
8	<b>Function 8</b>	Define the data (column format) for the character code page.
9	<b>Function 9</b>	Define the data (raster format) for the character code page.
10	<b>Function 10</b>	Delete the data for the character code page.
11	<b>Function 11</b>	Set the communication item for the serial interface.
12	<b>Function 12</b>	Transmit the communication item for the serial interface.
13	<b>Function 13</b>	Set the configuration item for the Bluetooth interface.
14	<b>Function 14</b>	Transmit the configuration item for the Bluetooth interface.
48	<b>Function 48</b>	Delete the paper layout
49	<b>Function 49</b>	Set the paper layout
50	<b>Function 50</b>	Transmit the paper layout information

- **pL, pH** specifies (**pL + pH × 256**) as the number of bytes after **pH (fn** and **[parameters]**). Description of the **[parameters]** is described in each function.

[Notes]

- The value of parameter **fn** determines the function number for this command. Command operation differs, depending on the function number.
- User setting mode is a special mode to change settings for the printer's built-in non-volatile memory.
- To change a setting, you must change the printer into user setting mode, using Function 1.
- Execute function 2 of this command after making the setting. The setting value is effective after executing the software reset of function 2.
- Note the rules below for the user setting mode:
  - The printer does not process character data.
  - The printer does not process commands other than this command and the **GS I** command.
  - The printer does not process real-time commands.
  - Even if the ASB function is enabled, the printer does not transmit the ASB status.
- Functions 4, 6, 12, 14 and 50, the functions used to transmit the current settings to the host, can be used at any time, without changing into the user setting mode.
- Data is written to the non-volatile memory by Functions 3, 5, 7, 11, 13, 48, and 49. Note the following when using those functions:
  - Do not turn off the power or reset the printer from the interface when the relevant functions are being executed.
  - The printer might be BUSY. In this case, be sure not to transmit a command from the host because the printer will not receive the data.
  - Excessive use of this function may destroy the non-volatile memory. As a guideline, do not use any combination of the following commands more than 10 times per day for writing data to the non-volatile memory: **GS ( A** (part of functions), **GS ( C** (part of functions), **GS ( E** (part of functions), **GS ( L / GS 8 L** (part of functions), **GS ( M** (part of functions), **GS g 0, FS g 1, FS q.**

[Notes for transmission process]

- Data is transmitted by Functions 1, 4, 6, 12, 14 and 50. When you use these functions, obey the following rules.

- When the host PC transmits the function data, transmit the next data after receiving the corresponding data from the printer.
- With a serial interface printer, be sure to use this function when the host can receive data.
- With a parallel interface printer, data transmitted (excluding ASB status) with this command (“Header to NUL”) is temporarily stored in the printer transmit buffer, as with other data. When the host goes into reverse mode, the printer then transmits the data sequentially from the beginning of the transmit buffer. Transmit buffer capacity is 99 bytes. Data exceeding this amount is lost. Therefore, when using this command, promptly change into reverse mode to start the data receive process.
- When communication with the printer uses XON/XOFF control with serial interface, the XOFF code may interrupt the “Header to NUL” data string.
- The transmission information for each function can be identified to other transmission data according to specific data of the transmission data block. When the header transmitted by the printer is [hex = 37H/decimal =55], treat NUL [hex = 00H/decimal =0] as a data group and identify it according to the combination of the header and the identifier.

[Notes for ESC/POS Handshaking Protocol]

■ Use ESC/POS Handshaking Protocol below for Functions 14.

Step	Host process	Printer process
1	Send <b>GS ( C &lt;Function 14&gt;</b> .	Start processing of Function 14. (Read specified record back to host.)
2	Receive data from printer.	Send device data.
3	Send response code. <sup>(*1)</sup>	Continue processing <sup>(*2) (*3)</sup> according to response.

(\*1) Response code

ASCII	Hex	Decimal	Request
ACK	06	6	Send next data.
NAK	15	21	Resend previously sent data.
CAN	18	24	Cancel send process.

(\*2) Processing according to response (unsent data exists, identified by send data set "Identification status")

Response code	Process
ACK	Start send processing for next data.
NAK	Resend previously sent data.
CAN	End processing for this command.

■ Processing the codes except for ACK, NAK, and CAN performs the same processing as **CAN**.

(\*3) Processing according to response (no unsent data, identified by send data set "Identification status")

Response code	Process
ACK, CAN	End processing for this command.
NAK	Resend previously sent data.

### Program Example 1 (Set customized memory value)

```
PRINT #1, CHR$( &H1D); " (E";CHR$(3);CHR$(0);CHR$(1);CHR$(73);CHR$(78); ← <Function 1>
  GOSUB *RECEIVE ←Check "mode change notice" (Details omitted)
PRINT #1, CHR$( &H1D); " (E";CHR$(10);CHR$(0);CHR$(3);CHR$(1); ← <Function 3>
PRINT #1, CHR$(50);CHR$(50);CHR$(50);CHR$(50);CHR$(48);CHR$(49);CHR$(48);CHR$(49);
PRINT #1, CHR$( &H1D); " (E";CHR$(2);CHR$(0);CHR$(4);CHR$(1); ← <Function 4>
GOSUB *RECEIVE 4 ←Check the setting (Details omitted)
PRINT #1, CHR$( &H1D); " (E";CHR$(7);CHR$(0);CHR$(5);CHR$(1);CHR$(2);CHR$(0);CHR$(2);CHR$(5);CHR$(0); ← <Function 5>
PRINT #1, CHR$( &H1D); " (E";CHR$(2);CHR$(0);CHR$(6);CHR$(1); ← <Function 6>
GOSUB *RECEIVE 6 ←Check the setting (Details omitted)
PRINT #1, CHR$( &H1D); " (E";CHR$(4);CHR$(0);CHR$(2);CHR$(79);CHR$(85);CHR$(84); ← <Function 2>
```

### Program Example 2 (Read back customized memory value)

```
PRINT #1, CHR$( &H1D); " (E";CHR$(2);CHR$(0);CHR$(6);CHR$(1); ← <Function 6>
```

[Model-dependent variations]

**TM-J2000/J2100, TM-T90, TM-T88IV, TM-T70, TM-L90, TM-P60, TM-U220**

## **TM-J2000/J2100, TM-T90**

This printer supports <Function 1>, <Function 2>, and the following functions:

- Functions related to printer operational settings: <Function 3 ~ 6>.
- Functions related to editing user-defined pages: <Function 7 ~ 10>.
- Functions related to the serial interface: <Function 11> <Function 12>.

## **TM-T88IV**

This printer supports <Function 1>, <Function 2>, and the following functions:

- Functions related to printer operational settings: <Function 5> <Function 6>.
- Functions related to the serial interface: <Function 11> <Function 12>.

However, the setting values of this command do not affect printing when the power saving mode is selected. Two-color printing is not possible in the power saving mode. Furthermore, print density, printing speed, and head energizing strokes are performed with reduced power control. Select the power saving mode with DIP switches [SW2-3] and [SW2-4]. Setting both DIP switches to ON sets the power saving mode. Turn off the printer before changing DIP switch settings.

## **TM-T70**

This printer supports <Function 1>, <Function 2>, and the following functions:

- Functions related to printer operational settings: <Function 5> <Function 6>.
- Functions related to the serial interface: <Function 11> <Function 12>.

However, the setting values of this command do not affect printing when the power saving mode is selected. In the power saving mode, print density, printing speed, and head energizing strokes are performed with reduced power control. Select the power saving mode with DIP switches [SW2-3] and [SW2-4]. Setting both DIP switches to ON sets the power saving mode. Turn off the printer before changing DIP switch settings.

## TM-L90

This printer supports <Function 1>, <Function 2>, and the following functions:

- Functions related to printer operational settings: <Function 3 ~ 6>.
- Functions related to editing user-defined pages: <Function 7 ~ 10>.
- Functions related to the serial interface: <Function 11> <Function 12>.
- Functions for paper layout <Function 48 ~ 50>.

## TM-P60

This printer supports <Function 1>, <Function 2>, and the following functions:

- Functions related to printer operational settings: <Function 3 ~ 6>.
- Functions related to editing user-defined pages: <Function 7> <Function 9> <Function 10>.
- Functions related to the serial interface: <Function 11> <Function 12>.
- The Bluetooth interface related functions: <Function 13> <Function 14>.

Functions related to the Bluetooth interface (<Function 13> and <Function 14>) are supported by the Bluetooth specification.

## TM-U220

This printer supports <Function 1>, <Function 2>, and the following functions:

- Functions related to printer operational settings: <Function 3 ~ 6>.
- Functions related to the serial interface: <Function 11> <Function 12>.

## GS ( E p<sub>L</sub> p<sub>H</sub> fn d1 d2 <Function 1>

---

[Name] Change into the user setting mode

[Format] ASCII GS ( E p<sub>L</sub> p<sub>H</sub> fn d1 d2  
 Hex 1D 28 45 03 00 01 49 4E  
 Decimal 29 40 69 3 0 1 73 78

[Range] (p<sub>L</sub> + p<sub>H</sub> × 256) = 3 (p<sub>L</sub> = 3, p<sub>H</sub> = 0)  
 fn = 1  
 d1 = 73  
 d2 = 78

[Description] Enters the user setting mode and transmits the mode change notice.

- "ESC/POS transmission handshake" is unnecessary with this function.

- [Notes]
- If the printer is in standard mode, this command is valid only at the beginning of the line.
  - If the printer is in page mode, this command is ignored.
  - Do not use this function while defining macros, because macros cannot be included with this function.
  - When the printer goes into the user setting mode, it transmits a "mode change notice" back to the host.

Transmit data	Hex	Decimal	Data quantity
Header	37H	55	1 byte
Identifier	20H	32	1 byte
NUL	00H	0	1 byte

- When it has executed this function, send the next commands after checking the "mode change notice."
- See previous [Notes for transmission process] for process sending data group.

## GS ( E *pL pH fn d1 d2 d3* <Function 2>

---

[Name] End the user setting mode session

[Format]

ASCII	GS (	E	<b>pL</b>	<b>pH</b>	<b>fn</b>	<b>d1</b>	<b>d2</b>	<b>d3</b>
Hex	1D 28 45	<b>04</b>	<b>00</b>	<b>02</b>	<b>4F</b>	<b>55</b>	<b>54</b>	
Decimal	29 40 69	<b>4</b>	<b>0</b>	<b>2</b>	<b>79</b>	<b>85</b>	<b>84</b>	

[Range] (**pL** + **pH** × 256) = 4 (pL = 4, pH = 0)  
**fn** = 2  
**d1** = 79  
**d2** = 85  
**d3** = 84

[Description] Ends the user setting mode, and performs a software reset.

- [Notes]
- This function is performed when the printer is in user setting mode.
  - After the software reset, the printer goes into the power on state.
  - Executing this function enables setting values set in user setting mode (such as memory switch or customize value).
  - Be sure to execute this function after changing all the setting values.



## GS ( E *p<sub>L</sub>* *p<sub>H</sub>* *fn* [*a*<sub>1</sub> *b*<sub>1</sub>*s*...*b*<sub>1</sub>]*...*[*a*<sub>*k*</sub> *n*<sub>*k*</sub>*s* *n*<sub>*k*</sub>]*1*) <Function 3>

---

[Name]	Change the memory switch
[Format]	ASCII      GS (    E <b>p<sub>L</sub></b> <b>p<sub>H</sub></b> <b>fn</b> [ <b>a<sub>1</sub></b> <b>b<sub>1</sub><i>s</i>...b<sub>1</sub></b> ] <b>...</b> [ <b>a<sub><i>k</i></sub></b> <b>n<sub><i>k</i></sub><i>s</i></b> <b>n<sub><i>k</i></sub></b> ] <b>1</b> Hex        1D 28 45 <b>p<sub>L</sub></b> <b>p<sub>H</sub></b> <b>03</b> [ <b>a<sub>1</sub></b> <b>b<sub>1</sub><i>s</i>...b<sub>1</sub></b> ] <b>...</b> [ <b>a<sub><i>k</i></sub></b> <b>n<sub><i>k</i></sub><i>s</i></b> <b>n<sub><i>k</i></sub></b> ] <b>1</b> Decimal    29 40 69 <b>p<sub>L</sub></b> <b>p<sub>H</sub></b> <b>3</b> [ <b>a<sub>1</sub></b> <b>b<sub>1</sub><i>s</i>...b<sub>1</sub></b> ] <b>...</b> [ <b>a<sub><i>k</i></sub></b> <b>n<sub><i>k</i></sub><i>s</i></b> <b>n<sub><i>k</i></sub></b> ] <b>1</b>
[Range]	$10 \leq (\mathbf{p_L} + \mathbf{p_H} \times 256) \leq 65530$ ( $0 \leq \mathbf{p_L} \leq 255, 0 \leq \mathbf{p_H} \leq 255: (\mathbf{p_L} + \mathbf{p_H} \times 256) = 9 \times \mathbf{k} + 1$ ) <b>fn</b> = 3 <b>b</b> = 48, 49, 50 $1 \leq \mathbf{k} \leq 7281$ <b>TM-J2000/J2100, TM-T90:</b> <b>a</b> = 1, 2, 8 <b>TM-L90:</b> <b>a</b> = 1, 7, 8 (TM-L90 with Peeler) <b>a</b> = 1, 2, 8 (TM-L90 models without Peeler) <b>TM-P60:</b> <b>a</b> = 8 <b>TM-U220:</b> <b>a</b> = 2, 8
[Default]	<b>TM-J2000/J2100:</b> [Msw2-1] and [Msw2-2] are ON ( <b>b</b> = 49) and the others are OFF ( <b>b</b> = 48). <b>TM-T90:</b> [Msw2-1] and [Msw2-2] and [Msw8-8] are ON ( <b>b</b> = 49), and others are OFF ( <b>b</b> = 48). <b>TM-L90:</b> [Msw8-2], [Msw8-6], and [Msw8-8] are ON ( <b>b</b> = 49), and others are OFF ( <b>b</b> = 48) [TM-L90 with Peeler]. [Msw2-2], and [Msw8-8] are ON ( <b>b</b> = 49), and others are OFF ( <b>b</b> = 48) [TM-L90 models without Peeler]. <b>TM-P60:</b> [Msw8-1] ~ [Msw8-5] are ON ( <b>b</b> = 49) [TM-P60 with IEEE802.11b]. [Msw8-1], [Msw8-2], [Msw8-4] and [Msw8-5] are ON ( <b>b</b> = 49), and [Msw8-3] is OFF ( <b>b</b> = 48)[TM-P60 with the Bluetooth interface]. [Msw8-1] ~ [Msw8-5] are ON ( <b>b</b> = 49), and [Msw8-6] is OFF ( <b>b</b> = 48) [TM-P60 with Peeler] <b>TM-U220:</b> all memory switches are OFF ( <b>b</b> = 48).

[Description]

Changes the memory switch specified by **a** to the values specified by **b**.

<b>b</b>	<b>Function</b>
48	Set to OFF.
49	Set to ON.
50	Does not change the memory switch.

■ When **a** = 1, memory switch 1 is set as follows:

<b>Msw</b>	<b>Setting value (b)</b>	<b>Function</b>
1-1	48	Does not transmit the power ON notice
	49	Transmits the power ON notice when processing an initialization
1-2	48	Sets receive buffer capacity to "big"
	49	Sets receive buffer capacity to "small"
1-3	48	BUSY when "receive buffer full" or "offline"
	49	BUSY when "receive buffer full"
1-4	48	Data processing when occurring receive error: Replace with "?"
	49	Data processing when occurring receive error: Ignore the data
1-5	48	Disables auto line spacing
	49	Enables auto line spacing
1-6	48	DM-D (customer display) connection: disconnected
	49	DM-D (customer display) connection: connected
1-7	48	Uses #6 pin for reset signal
	49	Does not use #6 pin for reset signal
1-8	48	Uses #25 pin for reset signal
	49	Does not use #25 pin for reset signal

Msw 1-2: The receive buffer capacity differs, depending on the printer model.

Msw 1-4, 1-6, 1-7, 1-8: Activated only with the serial interface printers.

Msw 1-5: Activated only with the parallel interface printers.

- When **a** = 2, memory switch 2 is set as follows:

Msw	Setting value (b)	Function
2-1	49	Reserved
2-2	48	Autocutter is provided
	49	Autocutter is not provided
2-3	48	Character code system for the simplified Chinese model: GB18030
	49	Character code system for the simplified Chinese model: GB2312
2-4 to 2-8	50	Reserved

- Specifications when memory switches 7 (**a** = 7) and 8 (**a** = 8) are different, depending on the printer models.

[Notes]

- This function works only in the user setting mode.
- The value of the memory switch is specified from bit 8 to bit 1 by **b18...b11**. When **b** = 50, the status of the bit applied is not changed.

Example:

Transmission data that specifies memory switch 1, "Transmits the power ON notice" and does not change other settings.

[Format]	ASCII	<b>GS ( E pL pH fn a b8 b7 b6 b5 b4 b3 b2 b1</b>
	Hex	1DH 28H 45H 0AH 00H 03H 01H 32H 32H 32H 32H 32H 32H 32H 31H
	Decimal	29 40 69 10 0 3 1 50 50 50 50 50 50 50 49

- Specifies **b** = 50 or depends on each model for a reserved bit.
- Memory switches set are valid until the following operations are executed. They are not initialized by power off or **ESC @**.
  - Execution of this function.
  - Execution of memory switch setting mode by panel operation when the power is turned on (supported by some printer models.)

# CONFIDENTIAL

[Explanation for memory switch 1] (**a** = 1):]

- Power on notice specified by [Msw1-1] (the first bit):

Power ON notice	Hex	Decimal	Data quantity
Header	3BH	59	1 byte
Identifier	31H	49	1 byte
NUL	00H	0	1 byte

- The printer transmits the power on notice for the following processes:
  - Initializing by turning on the power by switch.
  - Initializing by hardware reset.
  - Initializing by software reset, such as by transmitting Function 2.
  - Initializing after the self test.
- With a serial interface, when communication with the printer uses XON/XOFF control, the XOFF code may interrupt the "Header to NUL" data string.
- With a parallel interface, it is desirable for the host to be in a reverse idle state; however, because the host computer cannot always be in the reverse idle state, it is necessary to enter reverse mode regularly to watch for a power-on notice.

[Explanation for memory switch 2] (**a** = 2):]

- Character code system is specified by [Msw2-3] (the third bit) as shown in the following table.:

Character code system	Number of characters
GB2312	7,580
GB18030	28,553

[Model-dependent variations]

**TM-J2000/J2100, TM-T90, TM-T88IV, TM-T70, TM-L90, TM-P60, TM-U220**

## TM-J2000/J2100

Receive buffer capacity [Msw 1-2]: Large (when **b** = 48) = 4 KB; small (when **b** = 49) = 45 bytes

This printer doesn't support [Msw 2-3] (Selecting character code system for the simplified Chinese model)

- When **a** = 8, memory switch 8 is set as follows:

Msw	Setting value (b)	Function
8-1 to 8-7	50	Reserved
8-8	48	Roll paper cover open during printing: automatic recoverable error
	49	Roll paper cover open during printing: recoverable error

Setting the memory switch ([Msw 1-2] ~ [Msw 1-5], [Msw 1-7], [Msw 1-8], [Msw 2-2]) can be changed by "Memory switch setting mode" by the panel switch operation when the power supply is turned on.

## TM-T90

Receive buffer capacity [Msw 1-2]: Large (when **b** = 48) = 4 KB; small (when **b** = 49) = 45 bytes

This printer doesn't support [Msw 1-6] (DM-D (Customer display) is connected or not)) and [Msw 2-3] (Selecting character code system for the simplified Chinese model)

- When **a** = 8, memory switch 8 is set as follows:

<Other than Japanese model>

Msw	Setting value (b)	Function
8-1, 8-2	50	Reserved
8-3	48	PAPER LED is on when a paper near end is detected
	49	PAPER LED is off when a paper near end is detected
8-4	50	Reserved
8-5	48	Spacing of both sides for bar code: not inserted
	49	Spacing of both sides for bar code: inserts a space
8-6	50	Reserved

8-7	48	Compatibility with <b>TM-T88II</b> : not compatible
	49	Compatibility with <b>TM-T88II</b> : compatible
8-8	48	Roll paper cover open during printing: automatic recoverable error
	49	Roll paper cover open during printing: recoverable error

Setting of [Msw 8-3] is supported differently, depending on the firmware version.

Setting of [Msw 8-5] affects the performing of command **GS k**.

Settings of [Msw 8-7] affect the operation of **ESC &**, **ESC c 3**, **GS \***.

<Japanese model>

Msw	Setting value (b)	Function
8-1, 8-2	50	Reserved
8-3	48	PAPER LED is on when a paper near end is detected
	49	PAPER LED is off when a paper near end is detected
8-4	50	Reserved
8-5	48	Spacing of both sides for bar code: not inserted
	49	Spacing of both sides for bar code: inserts a space
8-6 to 8-7	50	Reserved
8-8	48	Roll paper cover open during printing: automatic recoverable error
	49	Roll paper cover open during printing: recoverable error

Setting of [Msw 8-3] is supported differently, depending on the firmware version.

Setting of [Msw 8-5] affects the performing of command **GS k**.

Setting the memory switch can be changed by “Memory switch setting mode” by the panel switch operation when the power supply is turned on as shown below.

Printer model	The memory switch can be changed by “Memory switch setting mode”
Other than Japanese model	[Msw 1-1] ~ [Msw 1-4], [Msw 1-7], [Msw 1-8], [Msw 2-2], [Msw 8-7]
Japanese model	[Msw 1-2] ~ [Msw 1-4], [Msw 1-7], [Msw 1-8], [Msw 2-2]

## **TM-T88IV, TM-T70**

This printer does not support this function.

## TM-L90

### TM-L90 with Peeler:

Receive buffer capacity [Msw 1-2]: Large (when **b** = 48) = 4 KB; small (when **b** = 49) = 45 bytes

“DM-D (customer display) is connected or not” [Msw 1-6] function is not supported.

The settings of [Msw 1-2] ~ [Msw 1-4], [Msw 1-7], [Msw 1-8], and [Msw 8-4] can also be changed by the memory switch setting mode of the panel switch operation when turning on the power.

- When **a** = 7, memory switch 7 is set as follows:

Msw	Setting value (b)	Function
7-1 to 7-7	50	Reserved
7-8	48	Printer operation when the FEED button is pressed: Feeds paper to the next printing position on the next label
	49	Printer operation when the FEED button is pressed: Issues label

[Msw 7-8]: Enabled in the continuous issuing mode.

The process of label issuing is as follows:

Feeds paper to the label peeling position when the FEED button is pressed.

Feeds paper to the print starting position on the next label when the FEED button is pressed again.

- When **a** = 8, memory switch 8 is set as follows:

Msw	Setting value (b)	Function
8-1	48	Recovery from paper layout error: DLE ENQ execution or pressing the FEED button
	49	Recovery from paper layout error: DLE ENQ execution
8-2	48	Recovery from paper layout error: DLE ENQ execution or opening/closing the cover
	49	Recovery from paper layout error: DLE ENQ execution
8-3	48	PAPER LED is on when a paper near end is detected
	49	PAPER LED is off when a paper near end is detected

8-4	48	Sets the maximum length of automatic paper measurement to 160 mm
	49	Sets the maximum length of automatic paper measurement to 300 mm
8-5	48	Spacing of both sides for bar code: not inserted
	49	Spacing of both sides for bar code: inserts a space
8-6	48	Perform paper feed to the print starting position when power is turned on
	49	Not perform paper feed to the print starting position when power is turned on
8-7	50	Reserved
8-8	48	Roll paper cover open during printing: automatic recoverable error
	49	Roll paper cover open during printing: recoverable error

The settings of [Msw8-1] and [Msw8-2] affect the recovery operation from the paper layout error.

[Msw8-1] [Msw8-2]	Recovery operation from error
OFF	Can recover from the error by pressing the FEED button or by executing DLE ENQ. While the printer recovers from the error, paper layout is measured automatically and paper is fed to the label print starting position and the paper layout stored in the non-volatile memory is rewritten. When the peeling issuing mode is selected, the printer will be in the label removal state when paper layout is automatically measured. Operators should remove the label.
ON	Can recover by executing DLE ENQ. While the printer recovers from the error, paper is fed to the label print starting position. Change the setting of the paper layout stored in the non-volatile memory so that it matches the currently used paper layout. See function 49 of this command for setting the paper layout.

- Setting of [Msw 8-4] affects the performance as follows:
  - Executing "Automatic paper layout setting mode function (m = 64)" of GS ( A
  - Executing "Automatic paper layout setting mode function" by panel operation when turning on the power



■ Executing “Automatic Paper Recognition Function.” (The function is automatically executed when the printer has no setting of paper layout setting.)

- Setting of [Msw 8-5] affects the performing of command **GS k**.
- Settings of [Msw 8-6] affect the initializing operation when the power is turned on, when the paper layout (origin of layout) is “bottom of a label” or “top of a black mark.” Paper layout can be set by this function (Function 49) or “automatic setting of paper layout” function (by **GS ( A (m = 64)** or panel operation).
- When [Msw 8-6] is set to **b = 49** (does not perform paper feed to the print starting position when power is turned on), printer performs assuming that paper is set to the print starting position. Therefore, the user should note the following.
  - a) Turn off the power after feeding paper to the print starting position.
  - b) Do not open the roll paper cover or replace roll paper when power is off.
  - c) If the roll paper cover is opened while power is off, open the cover to feed paper to the print start position after the power is turned on.
  - d) If the print starting position is not set when power is turned on, the print position of the first sheet may shift, or a paper layout error may occur.

**TM-L90 models without peeler:**

Receive buffer capacity [Msw 1-2]: Large (when **b = 48**) = 4 KB; small (when **b = 49**) = 45 bytes

“DM-D (customer display) is connected or not” [Msw 1-6] function is not supported.

“Selecting character code system for the simplified Chinese model” [Msw 2-3] is not supported.

Setting the memory switch ([Msw 1-2] ~ [Msw 1-4], [Msw 1-7], [Msw 1-8], [Msw 2-2], [Msw 8-4]) can be changed by “Memory switch setting mode” by the panel switch operation when the power supply is turned on.

- When **a = 8**, memory switch 8 is set as follows:

Msw	Setting value (b)	Function
8-1	50	Reserved
8-2	48	Recovery from paper layout error: DLE ENQ execution or opening/closing the cover
	49	Recovery from paper layout error: DLE ENQ execution

8-3	48	PAPER LED is on when a paper near end is detected
	49	PAPER LED is off when a paper near end is detected
8-4	48	Sets the maximum length of automatic paper measurement to 160 mm
	49	Sets the maximum length of automatic paper measurement to 300 mm
8-5	48	Spacing of both sides for bar code: not inserted
	49	Spacing of both sides for bar code: inserts a space
8-6	48	Perform paper feed to the print starting position when power is turned on
	49	Not perform paper feed to the print starting position when power is turned on
8-7	50	Reserved
8-8	48	Roll paper cover open during printing: automatic recoverable error
	49	Roll paper cover open during printing: recoverable error

The setting of [Msw8-2] affects the recovery operation from the paper layout error. Memory switch [Msw8-2] is supported differently, depending on the firmware version.

[Msw8-2]	Recovery operation from error
OFF	Can recover from the error by opening/closing the printer cover or by executing DLE ENQ. While the printer recovers from the error, paper layout is measured automatically and paper is fed to the label print starting position. If the paper layout is stored in the non-volatile memory, it will be rewritten. Afterwards, the printer operates following the paper layout previously measured.
ON	Can recover by executing DLE ENQ. While the printer recovers from the error, paper is fed to the label print starting position. The paper layout stored in the non-volatile memory will not be changed. Change the setting of the paper layout stored in the non-volatile memory so that it matches the currently used paper layout. See function 49 of this command for setting the paper layout.

- Setting of [Msw 8-3] is supported differently, depending on the firmware version.
- Setting of [Msw 8-4] affects the performance as follows:
  - Executing "Automatic paper layout setting mode function (m = 64)" of GS ( A

- Executing "Automatic paper layout setting mode function" by panel operation when turning on the power
- Executing "Automatic Paper Recognition Function." (The function is automatically executed when the printer has no setting of paper layout setting.)
- Setting of [Msw 8-5] affects the performing of command **GS k**.
- Settings of [Msw 8-6] affect the initializing operation when the power is turned on, when the paper layout (origin of layout) is "bottom of a label" or "top of a black mark". Paper layout can be set by this function (Function 49) or "automatic setting of paper layout" function (by **GS ( A (m = 64)** or panel operation).
- When [Msw 8-6] is set to **b = 49** (does not perform paper feed to the print starting position, when power is turned on), printer performs assuming that paper is set to the print starting position. Therefore, user should note the following.
  - a) Turn off the power after feeding paper to the print starting position.
  - b) Do not open the roll paper cover or replace roll paper when power is off.
  - c) If the roll paper cover is opened while power is off, open the cover to feed paper to the print start position after the power is turned on.
  - d) If the print starting position is not set when power is turned on, the print position of the first sheet may shift, or a paper layout error may occur.

## TM-P60

- Peeler models:

When **a = 8**, memory switch 8 is set as follows:

Msw	Setting value (b)	Function
8-1	48	Power ON/Power OFF notification transmission and battery status is not transmitted automatically
	49	Power ON/Power OFF notification transmission and battery status is transmitted automatically
8-2	48	No beeps for low battery
	49	Beeps for low battery
8-3	48	No beeps for host disconnection
	49	Beeps for host disconnection

8-4	48	No beeps for roll paper end
	49	Beeps for roll paper end
8-4	48	No beeps for recoverable and non-recoverable error occurred
	49	Beeps for recoverable and non-recoverable error occurred
8-5 ~ 8-6	50	Reserved
8-8	48	"Print starting position" is not the paper position immediately after a specific status
	49	"Print starting position" is the paper position immediately after a specific status
8-7 ~ 8-8	50	Reserved

Setting of [Msw8-1] affects the operation of **DLE DC4 (fn=2)** but not affect the operation of **DLE DC4 (fn=7)**.

Settings of [Msw8-2] ~ [Msw8-5] do not affect the operation of function 48 of **ESC (A)**.

[Msw8-6]: "Specific status" indicates when the peeler cover is closed, when the power is turned on, and when the printer is reset.

### TM-P60 models without Peeler

- When a = 8, memory switch 8 is set as follows:

Msw	Setting value (b)	Function
8-1	48	Power ON/Power OFF notification transmission and battery status is not transmitted automatically
	49	Power ON/Power OFF notification transmission and battery status is transmitted automatically
8-2	48	No beeps for low battery
	49	Beeps for low battery
8-3	48	No beeps for host disconnection
	49	Beeps for host disconnection
8-4	48	No beeps for roll paper end
	49	Beeps for roll paper end

8-4	48	No beeps for recoverable and non-recoverable error
	49	Beeps for recoverable and non-recoverable error
8-5 ~ 8-6	50	Reserved

Setting of [Msw8-1] affects the operation of **DLE DC4 (fn =2)** but not not affect the operation of **DLE DC4 (fn=7)**.

Settings of [Msw8-2] ~ [Msw8-5] do not affect the operation of function 48 of **ESC (A)**.

## TM-U220

“Auto cutter is provided or not” [Msw 2-3] is not supported.

- When a = 8, memory switch 8 is set as follows:

Msw	Setting value (b)	Function
8-1 to 8-4	50	Reserved
8-5	48	The printer status is sent back as “the paper empty” when the roll paper cover is opened.
	49	The printer status is sent back “the roll paper cover open” when the roll paper cover is opened.
8-6	48	Reserved: Fixed to OFF (Don’t change the setting)
8-7	48	Printer BUSY is released when the remaining capacity of the receive buffer goes to 256 bytes.
	49	Printer BUSY is released when the remaining capacity of the receive buffer goes to 138 bytes.
8-8	48	Printer cover open during operation: Error that automatically recovers.
	49	Printer cover open during operation: Error that can possibly recover.

- Setting of [Msw 8-5] affects the statuses as follows:
  - Basic ASB status (See “GS a” command)
  - Real-time status (See “DLE EOT” command)

Setting the memory switch ([Msw 8-5], [Msw 8-7]) can be changed by “Memory switch setting mode” by the panel switch operation when the power supply is turned on.

## GS ( E pL pH fn a <Function 4>

---

[Name] Transmit the settings of the memory switch

[Format] ASCII GS ( E pL pH fn a  
 Hex 1D 28 45 02 00 04 a  
 Decimal 29 40 69 2 0 4 a

[Range] (pL + pH × 256) = 2 (pL = 2, pH = 0)  
 fn = 4  
**TM-J2000/J2100, TM-T90: a = 1, 2, 8**  
**TM-L90: a = 1, 7, 8 (TM-L90 with Peeler)**  
**a = 1, 2, 8 (TM-L90 models without Peeler)**

**TM-P60: a = 8**

**TM-U220: a = 2, 8**

[Description] Transmits the setting value of the memory switch specified by a.

- "ESC/POS transmission handshake" is unnecessary with this function.

[Notes] ■ This function works both in user setting mode and during normal printer operation.  
 ■ The printer transmits the "Header to NUL" data shown below:

Transmit data	Hex	Decimal	Data quantity
Header	37H	55	1 byte
Identifier	21H	33	1 byte
Setting value	30H or 31H	48 or 49	8 byte
NUL	00H	0	1 byte

- The value of the memory switch is transmitted from bit 8 to bit 1.  
 Example: The transmit data when bits 8 and 7 are On and the other bits are Off is 11 bytes of [Hexadecimal = 37H, 21H, 31H, 31H, 30H, 30H, 30H, 30H, 30H, 30H, 00H/Decimal = 55, 33, 49, 49, 48, 48, 48, 48, 48, 0].
- See description of <Function 3> of this command for details of memory switch.
- See [Notes for the processing to transmit data] for description of the processing to transmit data.

# CONFIDENTIAL

[Model-dependent variations]

**TM-T88IV, TM-T70**

**TM-T88IV, TM-T70**

**This printer does not support this function.**

# CONFIDENTIAL

## GS ( E p<sub>L</sub> p<sub>H</sub> fn [a<sub>1</sub> n<sub>1L</sub> n<sub>1H</sub>]...[a<sub>k</sub> n<sub>kL</sub> n<sub>kH</sub>] <Function 5>

---

[Name]	Set the customized setting values						
[Format]	ASCII	GS (	E	p <sub>L</sub>	p <sub>H</sub>	fn	[a <sub>1</sub> n <sub>1L</sub> n <sub>1H</sub> ] ... [a <sub>k</sub> n <sub>kL</sub> n <sub>kH</sub> ]
	Hex	1D 28 45		p <sub>L</sub>	p <sub>H</sub>	05	[a <sub>1</sub> n <sub>1L</sub> n <sub>1H</sub> ] ... [a <sub>k</sub> n <sub>kL</sub> n <sub>kH</sub> ]
	Decimal	29 40 69		p <sub>L</sub>	p <sub>H</sub>	5	[a <sub>1</sub> n <sub>1L</sub> n <sub>1H</sub> ] ... [a <sub>k</sub> n <sub>kL</sub> n <sub>kH</sub> ]
[Range]	4 ≤ (p <sub>L</sub> + p <sub>H</sub> × 256) ≤ 65533 (0 ≤ p <sub>L</sub> ≤ 255, 0 ≤ p <sub>H</sub> ≤ 255: (p <sub>L</sub> + p <sub>H</sub> × 256) = 3 × k + 1) fn = 5 1 ≤ k ≤ 21844						
	<b>TM-J2000/J2100:</b> a = 3 (n <sub>L</sub> + n <sub>H</sub> × 256) = 2,4,5,6 (n <sub>L</sub> = 2,4,5,6, n <sub>H</sub> = 0)						
	<b>TM-T90:</b> a = 1, 2, 3, 5, 6, 97, 116,118 [Other than Japanese model] a = 1, 2, 3, 5, 6, 97, 116 [Japanese model] 1 ≤ (n <sub>L</sub> + n <sub>H</sub> × 256) ≤ 4 (1 ≤ n <sub>L</sub> ≤ 4, n <sub>H</sub> = 0) [a = 1] 1 ≤ (n <sub>L</sub> + n <sub>H</sub> × 256) ≤ 7 (1 ≤ n <sub>L</sub> ≤ 7, n <sub>H</sub> = 0) [a = 2] (n <sub>L</sub> + n <sub>H</sub> × 256) = 2,3,6 (n <sub>L</sub> = 2,3,6, n <sub>H</sub> = 0) [a = 3] 0 ≤ (n <sub>L</sub> + n <sub>H</sub> × 256) ≤ 6, 65530 ≤ (n <sub>L</sub> + n <sub>H</sub> × 256) ≤ 65535 [a = 5] (0 ≤ n <sub>L</sub> ≤ 6, n <sub>H</sub> = 0), (250 ≤ n <sub>L</sub> ≤ 255, n <sub>H</sub> = 255) 1 ≤ (n <sub>L</sub> + n <sub>H</sub> × 256) ≤ 11 (1 ≤ n <sub>L</sub> ≤ 11, n <sub>H</sub> = 0) [a = 6: Japanese model] 1 ≤ (n <sub>L</sub> + n <sub>H</sub> × 256) ≤ 9 (1 ≤ n <sub>L</sub> ≤ 9, n <sub>H</sub> = 0) [a = 6: Other than Japanese model] 1 ≤ (n <sub>L</sub> + n <sub>H</sub> × 256) ≤ 4 (1 ≤ n <sub>L</sub> ≤ 4, n <sub>H</sub> = 0) [a = 97] (n <sub>L</sub> + n <sub>H</sub> × 256) = 1, 257 (n <sub>L</sub> = 1, n <sub>H</sub> = 0, 1) [a = 116] (n <sub>L</sub> + n <sub>H</sub> × 256) = 70, 85, 100 (n <sub>L</sub> = 70, 85, 100, n <sub>H</sub> = 0) [a = 118]						
	<b>TM-T88IV:</b> a = 5, 6, 97, 116, 118 0 ≤ (n <sub>L</sub> + n <sub>H</sub> × 256) ≤ 6, (n <sub>L</sub> + n <sub>H</sub> × 256) = 100, 65530 ≤ (n <sub>L</sub> + n <sub>H</sub> × 256) ≤ 65535 [a = 5] (0 ≤ n <sub>L</sub> ≤ 6, n <sub>H</sub> = 0), (n <sub>L</sub> = 100, n <sub>H</sub> = 0), (250 ≤ n <sub>L</sub> ≤ 255, n <sub>H</sub> = 255) 1 ≤ (n <sub>L</sub> + n <sub>H</sub> × 256) ≤ 9 (1 ≤ n <sub>L</sub> ≤ 9, n <sub>H</sub> = 0) [a = 6] (n <sub>L</sub> + n <sub>H</sub> × 256) = 1, 2, 4, 128 (n <sub>L</sub> = 1, 2, 4, 128, n <sub>H</sub> = 0) [a = 97] (n <sub>L</sub> + n <sub>H</sub> × 256) = 1, 257 (n <sub>L</sub> = 1, n <sub>H</sub> = 0, 1) [a = 116] (n <sub>L</sub> + n <sub>H</sub> × 256) = 70, 85 (n <sub>L</sub> = 70, 85, n <sub>H</sub> = 0) [a = 118]						
	<b>TM-T70:</b> a = 5, 6, 97 [Other than Japanese model]						



$0 \leq (nL + nH \times 256) \leq 6, (nL + nH \times 256) = 100,$   
 $65530 \leq (nL + nH \times 256) \leq 65535 [a = 5]$   
 $(0 \leq nL \leq 6, nH = 0), (nL = 100, nH = 0), (250 \leq nL \leq 255, nH = 255)$   
 $1 \leq (nL + nH \times 256) \leq 9 (1 \leq nL \leq 9, nH = 0) [a = 6]$   
 $(nL + nH \times 256) = 1, 2, 4, 128 (nL = 1, 2, 4, 128, nH = 0) [a = 97]$   
 [Japanese model]

$0 \leq (nL + nH \times 256) \leq 4, (nL + nH \times 256) = 100,$   
 $65530 \leq (nL + nH \times 256) \leq 65535 [a = 5]$   
 $(0 \leq nL \leq 4, nH = 0), (nL = 100, nH = 0), (250 \leq nL \leq 255, nH = 255)$   
 $1 \leq (nL + nH \times 256) \leq 9 (1 \leq nL \leq 9, nH = 0) [a = 6]$   
 $(nL + nH \times 256) = 1, 2, 128 (nL = 1, 2, 128, nH = 0) [a = 97]$

**TM-L90:**

$a = 1, 2, 3, 5, 6, 97, 116, 118$   
 $1 \leq (nL + nH \times 256) \leq 4 (1 \leq nL \leq 4, nH = 0) [a = 1]$   
 $1 \leq (nL + nH \times 256) \leq 7 (1 \leq nL \leq 7, nH = 0) [a = 2]$   
 $0 \leq (nL + nH \times 256) \leq 8, 65530 \leq (nL + nH \times 256) \leq 65535 [a = 5]$   
 $(0 \leq nL \leq 8, nH = 0), (250 \leq nL \leq 255, nH = 255)$   
 $1 \leq (nL + nH \times 256) \leq 9 (1 \leq nL \leq 9, nH = 0) [a = 6]$   
 $1 \leq (nL + nH \times 256) \leq 4 (1 \leq nL \leq 4, nH = 0) [a = 97]$   
 $(nL + nH \times 256) = 1257 (nL = 1, nH = 0, 1) [a = 116]$   
 $38 \leq (nL + nH \times 256) \leq 80 (38 \leq nL \leq 80, nH = 0) [a = 117]$   
 $(nL + nH \times 256) = 70, 85, 100 (nL = 70, 85, 100, nH = 0) [a = 118]$

**TM-P60:**

$a = 5, 116$  [Peeler model]  
 $a = 3, 5, 116$  [TM-P60 models without Peeler]  
 $(nL + nH \times 256) = 2,3 (nL = 2,3, nH = 0) [a = 3]$   
 $0 \leq (nL + nH \times 256) \leq 6, 65530 \leq (nL + nH \times 256) \leq 65535 [a = 5]$   
 $(0 \leq nL \leq 6, nH = 0), (250 \leq nL \leq 255, nH = 255)$   
 $0 \leq (nL + nH \times 256) \leq 60, (0 \leq nL \leq 60, nH = 0) [a = 116]$

**TM-U220:**

$a = 3$   
 $nL + nH \times 256 = 2, 4, 5 (nL = 2, 4, 5, nH = 0)$

[Default]

**TM-J2000/J2100:**  $(nL + nH \times 256) = 5 (nL = 5, nH = 0)$  [default value when  $a = 3$ ]  
**TM-T90:**  $(nL + nH \times 256) = 1 (nL = 1, nH = 0)$  [default value when  $a = 1$ ]  
 $(nL + nH \times 256) = 7 (nL = 7, nH = 0)$  [default value when  $a = 2$ ]  
 $(nL + nH \times 256) = 6 (nL = 6, nH = 0)$

	[default value when a = 3: Other than Japanese model]
	$(nL + nH \times 256) = 2$ (nL = 2, nH = 0) [default value when a = 3: Japanese model]
	$(nL + nH \times 256) = 0$ (nL = 0, nH = 0) [default value when a = 5]
	$(nL + nH \times 256) = 11$ (nL = 11, nH = 0)
	[default value when a = 6: Japanese model]
	$(nL + nH \times 256) = 9$ (nL = 9, nH = 0)
	[default value when a = 6: Other than Japanese model]
	$(nL + nH \times 256) = 1$ (nL = 1, nH = 0) [default value when a = 97]
	$(nL + nH \times 256) = 1$ (nL = 1, nH = 0) [default value when a = 116]
	$(nL + nH \times 256) = 85$ (nL = 85, nH = 0) [default value when a = 118]
<b>TM-T88IV:</b>	$(nL + nH \times 256) = 100$ (nL = 100, nH = 0) [default value when a = 5]
	$(nL + nH \times 256) = 9$ (nL = 9, nH = 0) [default value when a = 6]
	$(nL + nH \times 256) = 128$ (nL = 128, nH = 0) [default value when a = 97]
	$(nL + nH \times 256) = 1$ (nL = 1, nH = 0) [default value when a = 116]
	$(nL + nH \times 256) = 85$ (nL = 85, nH = 0) [default value when a = 118]
<b>TM-T70:</b>	$(nL + nH \times 256) = 100$ (nL = 100, nH = 0) [default value when a = 5]
	$(nL + nH \times 256) = 9$ (nL = 9, nH = 0) [default value when a = 6]
	$(nL + nH \times 256) = 128$ (nL = 128, nH = 0) [default value when a = 97]
<b>TM-L90:</b>	$(nL + nH \times 256) = 1$ (nL = 1, nH = 0) [default value when a = 1]
	$(nL + nH \times 256) = 7$ (nL = 7, nH = 0) [default value when a = 2]
	$(nL + nH \times 256) = 0$ (nL = 0, nH = 0) [default value when a = 5]
	$(nL + nH \times 256) = 6$ (nL = 6, nH = 0) [default value when a = 6]
	$(nL + nH \times 256) = 1$ (nL = 1, nH = 0) [default value when a = 97]
	$(nL + nH \times 256) = 1$ (nL = 1, nH = 0) [default value when a = 116]
	$(nL + nH \times 256) = 80$ (nL = 80, nH = 0) [default value when a = 117]
	$(nL + nH \times 256) = 85$ (nL = 85, nH = 0) [default value when a = 118]
<b>TM-P60:</b>	$(nL + nH \times 256) = 2$ (nL = 2, nH = 0) [default value when a = 3]
	$(nL + nH \times 256) = 0$ (nL = 0, nH = 0) [default value when a = 5]
	$(nL + nH \times 256) = 20$ (nL = 20, nH = 0) [default value when a = 116]
<b>TM-U220:</b>	$(nL + nH \times 256) = 5$ (nL = 5, nH = 0) [default value when a = 3]

[Description] Changes the customized value specified by parameter **a** to  $(nL + nH \times 256)$ .

<b>a</b>	<b>Type of customized value</b>
1	NV user memory capacity
2	NV graphics memory capacity
3	Paper width
5	Print density
6	Print speed
97	Number of division of thermal head energizing
116, 117, 118	Value differs, depending on the printer models. See model-dependent variations.

- The setting unit specified by  $(nL + nH \times 256)$  differs, depending on the printer model.

[Notes]

- This function works only in user setting mode.
- Customized value is specified by unit of 3 bytes (**a**, **nL**, **nH**)  
 Ex: A transmitted data as specifying paper width;  
 ASCII:           GS   (    E    pL   pH   fn    a    nL    nH  
 Hexadecimal:   1D   2B   45   04   00   05   03   06   00  
 Decimal:        29   40   69    4    0    5    3    6    0
- To activate the customized values you set with this function, you must transmit a Function 2 command.
- When you change the (**a** = 1) or (**a** = 2) setting, the printer clears all data in the NV user memory and the NV graphics memory.
- If you attempt to set a combination of settings that is not possible, the NV graphics memory setting is reduced to an allowable value.
- The setting value of the print speed is effective when the printer performs in proper condition. Print speed may slow temporarily, depending on the operating environment or the print duty.

- Customized values set are valid until the following operations are executed. They are not initialized by power off or ESC @
  - Execution of this function.
  - Execution of memory switch setting mode by panel operation when the power is turned on (supported by some printer models.)

[Model-dependent variations]      **TM-J2000/J2100, TM-T90, TM-T88IV, TM-T70, TM-L90, TM-P60, TM-U220**

## TM-J2000/J2100

### ■ Paper width settings (a = 3)

(nL + nH × 256)	Paper width
2	58 mm {2.3"}
4	70 mm {2.8"}
5	76 mm {3.0"}
6	82.5 mm {3.3"}

## TM-T90

We recommend that Number of division of thermal heads energized be set to Divide into two for best print quality in 2-color printing.

This printer supports the model dependent customized value as shown in the following table.

a	Type of customized value
116	Select paper settings
118	Selects the black-color density in two-color printing

### ■ NV user memory capacity settings (a = 1)

(nL + nH × 256)	Memory capacity
1	1 KB
2	64 KB
3	128 KB
4	192 KB

## ■ NV graphics memory capacity settings (a = 2)

(nL + nH × 256)	Memory capacity
1*	None (0 bytes)
2	64 KB
3	128 KB
4	192 KB
5	256 KB
6	320 KB
7	384 KB

\* Not available NV graphics functions

Memory combinations that can be specified:

NV user memory capacity	NV graphics memory capacity
1 KB	384 KB or less
64 KB	256 KB or less
128 KB	128 KB or less
192 KB	None (0 bytes)

## ■ Paper width settings (a = 3)

(nL + nH × 256)	Paper width
2	58 mm {2.3"}
3	60 mm {2.4"}
6	80 mm {3.2"}

## ■ Print density settings (a = 5)

(nL + nH × 256)	Print density
65530	70%
65531	75%
65532	80%
65533	85%

(nL + nH × 256)	Print density
1	105%
2	110%
3	115%
4	120%

<b>(nL + nH × 256)</b>	<b>Print density</b>
65534	90%
65535	95%
0	100%

<b>(nL + nH × 256)</b>	<b>Print density</b>
5	125%
6	130%

■ **Print speed (a = 6)**

<b>(nL + nH × 256)</b>	<b>Print speed</b>
1	Print speed level 1
2	Print speed level 2
3	Print speed level 3
4	Print speed level 4
5	Print speed level 5
6	Print speed level 6
7	Print speed level 7
8	Print speed level 8
9	Print speed level 9
10	Print speed level 10
11	Print speed level 11

- Print level 1 is the lowest speed.

■ **Number of division of thermal head energizing (a = 97)**

<b>(nL + nH × 256)</b>	<b>Division number</b>
1	Divide into one
2	Divide into two
3	Divide into three
4	Divide into four

■ **Select paper settings (a = 116)**

<b>(nL + nH × 256)</b>	<b>Paper</b>
1	Specified white and black paper
257	Recommended two-color paper

■ Selects the black-color density in two-color printing (a = 118)

(nL + nH × 256)	The black-color density
70	Light
85	Medium
100	Dark

- This setting's value affects printing in black for two-color printing. Setting the "paper width," "print density," "select paper setting" (a = 3, 5, 116 ) can be changed by "Memory switch setting mode" by the panel switch operation when the power supply is turned on.

## TM-T88IV

This printer supports the model dependent customized value as shown in the following table.

a	Type of customized value
116	Selects the print control (single color/two-color)
118	Selects the black-color density in two-color printing

■ Print density settings (a = 5)

(nL + nH × 256)	Print density	
100	Set by DIP switches [SW2-3] and [SW2-4]	
65530	Print density level 1	Light
65531	Print density level 2	
65532	Print density level 3	
65533	Print density level 4	
65534	Print density level 5	
65535	Print density level 6	
0	Print density level 7	Medium
1	Print density level 8	
2	Print density level 9	
3	Print density level 10	

<b>(nL + nH × 256)</b>	<b>Print density</b>	
<b>4</b>	<b>Print density level 11</b>	<b> </b>
<b>5</b>	<b>Print density level 12</b>	<b> </b>
<b>6</b>	<b>Print density level 13</b>	<b>Dark</b>

■ **Print speed (a = 6)**

<b>(nL + nH × 256)</b>	<b>Print speed</b>		<b>Speed guideline</b>
<b>1</b>	<b>Print speed level 1</b>	<b>Slow</b>	<b>25 mm/s</b>
<b>2</b>	<b>Print speed level 2</b>	<b> </b>	<b>40 mm/s</b>
<b>3</b>	<b>Print speed level 3</b>	<b> </b>	<b>60 mm/s</b>
<b>4</b>	<b>Print speed level 4</b>	<b> </b>	<b>80 mm/s</b>
<b>5</b>	<b>Print speed level 5</b>	<b> </b>	<b>100 mm/s</b>
<b>6</b>	<b>Print speed level 6</b>	<b> </b>	<b>130 mm/s</b>
<b>7</b>	<b>Print speed level 7</b>	<b> </b>	<b>150 mm/s</b>
<b>8</b>	<b>Print speed level 8</b>	<b> </b>	<b>180 mm/s</b>
<b>9</b>	<b>Print speed level 9</b>	<b>Fast</b>	<b>200 mm/s</b>

■ **Number of division of thermal head energizing (a = 97)**

<b>(nL + nH × 256)</b>	<b>Division number</b>
<b>1</b>	<b>Divide into one</b>
<b>2</b>	<b>Divide into two</b>
<b>4</b>	<b>Divide into four</b>
<b>128</b>	<b>Automatic control</b>

- The setting value does not affect printing in single-color printing control mode.
- When two-color printing control is specified, the setting is "Fixed at two-part energizing."
- Print control (single-color/two-color) is specified with this function (a=116).



■ **Setting values of print control (a=116)**

<b>(nL + nH × 256)</b>	<b>Print control</b>
<b>1</b>	<b>Single-color printing control</b>
<b>257</b>	<b>Two-color printing control</b>

- When "Two-color printing control (257)" is specified, always use two-color paper.

■ **Selects the black-color density in two-color printing (a = 118)**

<b>(nL + nH × 256)</b>	<b>The black-color density</b>
<b>70</b>	<b>Light</b>
<b>85</b>	<b>Standard</b>

- This setting's value affects printing in black for two-color printing.

## TM-T70

■ **Print density settings (a = 5)**

<b>(nL + nH × 256)</b>	<b>Print density</b>	
<b>100</b>	<b>Set by DIP switches [SW2-3] and [SW2-4]</b>	
<b>65530</b>	<b>Print density level 1</b>	<b>Light</b>
<b>65531</b>	<b>Print density level 2</b>	
<b>65532</b>	<b>Print density level 3</b>	
<b>65533</b>	<b>Print density level 4</b>	
<b>65534</b>	<b>Print density level 5</b>	
<b>65535</b>	<b>Print density level 6</b>	
<b>0</b>	<b>Print density level 7</b>	<b>Medium</b>
<b>1</b>	<b>Print density level 8</b>	
<b>2</b>	<b>Print density level 9</b>	
<b>3</b>	<b>Print density level 10</b>	

(nL + nH × 256)	Print density	
4	Print density level 11	
5	Print density level 12	
6	Print density level 13	Dark

- The Japanese specification does not support "Print density level 12" and "Print density level 13."

## ■ Print speed (a = 6)

(nL + nH × 256)	Print speed	
1	Print speed level 1	Slow
2	Print speed level 2	
3	Print speed level 3	
4	Print speed level 4	
5	Print speed level 5	
6	Print speed level 6	
7	Print speed level 7	
8	Print speed level 8	
9	Print speed level 9	Fast

## ■ Number of division of thermal head energizing (a = 97)

(nL + nH × 256)	Division number
1	Divide into one
2	Divide into two
4	Divide into four
128	Automatic control

- When "Automatic control (128)" is selected, normally printing is performed with one-part energizing, and when high duty data is printed, there is a possibility that printing is performed temporarily with two-part energizing.
- The Japanese specification does not support "Fixed at four-part energizing."

## TM-L90

We recommend that Number of division of thermal head energizing be set to Divide into two for best print quality in 2-color printing.

This printer supports the model dependent customized value as shown in the following table.

a	Type of customized value
116	Select paper settings
117	Select paper width settings (in 1 mm units)
118	Selects the black-color density in two-color printing

### ■ NV user memory capacity settings (a = 1)

(nL + nH × 256)	Memory capacity
1	1 KB
2	64 KB
3	128 KB
4	192 KB

### ■ NV graphics memory capacity settings (a = 2)

(nL + nH × 256)	Memory capacity
1*	None (0 bytes)
2	64 KB
3	128 KB
4	192 KB
5	256 KB
6	320 KB
7	384 KB

\* Not available NV graphics functions

- **Memory combinations that can be specified:**

NV user memory capacity	NV graphics memory capacity
1 KB	384 KB or less
64 KB	256 KB or less
128 KB	128 KB or less
192 KB	None (0 bytes)

## ■ Print density settings (a = 5)

(nL + nH × 256)	Print density
65530	70%
65531	75%
65532	80%
65533	85%
65534	90%
65535	95%
0	100%
1	105%

(nL + nH × 256)	Print density
2	110%
3	115%
4	120%
5	125%
6	130%
7	135%
8	140%

## ■ Print control mode settings (a = 6)

(nL + nH × 256)	Print control mode
1	Level 1
2	Level 2
3	Level 3
4	Level 4
5	Level 5

(nL + nH × 256)	Print control mode
6	Level 6
7	Level 7
8	Level 8
9	Level 9

\* Level 1 is the slowest.

## ■ Number of division of thermal head energizing (a = 97)

(nL + nH × 256)	Paper
1	Divide into one
2	Divide into two
3	Divide into three
4	Divide into four

## ■ Select paper settings (a = 116)

(nL + nH × 256)	Paper
1	Specified white and black paper
257	Recommended two-color paper

## ■ Select paper width settings (a = 117)

(nL + nH × 256)	Paper width
38	38 mm {1.5"}
39	39 mm {1.6"}
:	:
79	79 mm {3.1"}
80	80 mm {3.2"}

- This printer can set each 1mm unit. However, this printer doesn't support 71~79mm roll paper. Therefore don't specify those values.

## ■ Selects the black-color density in two-color printing (a = 118)

(nL + nH × 256)	The black-color density
70	Light
85	Medium
100	Dark

- This setting's value affects printing in black for two-color printing. Setting the "print density," "select paper setting," "paper width," (a = 5, 116, 117 ) can be changed by "Memory switch setting mode" by the panel switch operation when the power supply is turned on.

## TM-P60

This printer supports the model dependent customized value as shown in the following table.

a	Type of customized value
116	Select auto-power off time

## ■ Paper width settings (a = 3)

(nL + nH × 256)	Paper width
2	58 mm {2.3"}
3	60 mm {2.4"}

- Peeler model does not support paper width (a = 3).

## ■ Print density settings (a = 5)

(nL + nH × 256)	Print density
65530	70%
65531	75%
65532	80%
65533	85%
65534	90%
65535	95%
0	100%

(nL + nH × 256)	Print density
1	105%
2	110%
3	115%
4	120%
5	125%
6	130%

## ■ Automatic power off time (a = 116)

(nL + nH × 256)	Automatic power off time (minute)
0	No power off
1	1
2	2
:	:
60	60

## TM-U220

## ■ Paper width settings (a = 3)

(nL + nH × 256)	Paper width
2	57.5mm {2.26"}
4	69.5 mm {2.74"}
5	76 mm {3.00"}

Setting the "paper width"(a = 3) can be changed by "Memory switch setting mode" by the panel switch operation when the power supply is turned on.

## GS ( E pL pH fn a <Function 6>

[Name] Transmit the customized setting values

[Format] ASCII GS ( E pL pH fn a  
 Hex 1D 28 45 02 00 06 a  
 Decimal 29 40 69 2 0 6 a

[Range] (pL + pH × 256) = 2 (pL = 2, pH = 0)  
 fn = 6

**TM-J2000/J2100, TM-U220: a = 3**

**TM-T90: a = 1, 2, 3, 5, 6, 97, 116, 118 [Other than Japanese model]**

a = 1, 2, 3, 5, 6, 97, 116 [Japanese model]

**TM-T88IV: a = 5, 6, 97, 116, 118**

**TM-T70: a = 5, 6, 97**

**TM-L90: a = 1, 2, 5, 6, 97, 116, 117, 118**

**TM-P60: a = 5, 116 [Peeler model]**

a = 3, 5, 116 [TM-P60 models without Peeler]

[Description] Transmits the customized value specified by a.

a	Type of customized value
1	NV user memory capacity
2	NV graphics memory capacity
3	Paper width
5	Print density
6	Print speed
97	Number of division of thermal head energizing
116, 117, 118	Value differs, depending on the printer model. See Function 5.

- "ESC/POS transmission handshake" is unnecessary with this function.

[Notes] ■ This function works both in user setting mode and during normal printer operation.

- The printer transmits the data below (“Header to NUL”) with this function:

Transmit data	Hex	Decimal	Data quantity
Header	37H	55	1 byte
Identifier	27H	39	1 byte
Value number <sup>(*1)</sup>	31H –39H	48 –57	1 –3 bytes
Separation code	1FH	31	1 byte
Setting <sup>(*2)</sup>	30H –39H	48 –57	1 –5 bytes
NUL	00H	0	1 byte

(\*1) The decimal value for the customized value number (**a**; parameter of this function) is converted to ASCII character data and sent starting from the high order end.

Example:

If the **a** is 118, the “118” (expressed hexadecimally as 31H, 31H, 38H. Decimally as 49, 49, 56) is converted to 3-bytes data.

(\*2) The customized value is determined by the value defined in Function 5.

Example:

When the customized value is 120, it is “120” expressed with 3 bytes of data (hex numbers: 31H, 32H, 30H / decimal numbers: 49, 50, 48).

- Even if the combination of settings requested in Function 5 is not possible, the printer transmits the settings made with Function 5. Note that this will differ from the memory capacity used during actual operation. The capacity of memory In fact can be checked by the following commands.
  - Capacity or unused capacity of NV user memory: **GS ( C** <Function 3>, <Function 4>
  - Capacity or unused capacity of NV graphics domain: **GS ( L** <Function 48>, <Function 51>
- See previous [Notes for transmission process] for process sending data group.

[Model-dependent variations]

**TM-T90, TM-T88IV, TM-L90, TM-P60**



## **TM-T90**

The setting value transmitted with customize value 116 (a = 116) is paper selection.

The setting value transmitted with customize value 118 (a = 118) is the black-color density in two-color printing.

## **TM-T88IV**

The setting value transmitted with customize value 116 (a = 116) is the print control selection (single color/two-color).

The setting value transmitted with customize value 118 (a = 118) is the black-color density in two-color printing.

## **TM-L90**

The setting value transmitted with customize value 116 (a = 116) is paper selection.

The setting value transmitted with customize value 117 (a = 117) is paper width.

The setting value transmitted with customize value 118 (a = 118) is the black-color density in two-color printing.

## **TM-P60**

The setting value transmitted with customize value 116 (a = 116) is automatic power off time selection.

# CONFIDENTIAL

## GS ( E pL pH fn a d1 d2 <Function 7>

---

[Name] Copy the user-defined page

[Format] ASCII GS ( E pL pH fn a d1 d2  
Hex 1D 28 45 04 00 07 a d1 d2  
Decimal 29 40 69 2 0 7 a d1 d2

[Range] (pL + pH × 256) = 4 (pL = 4, pH = 0)

fn = 7

d1 = 30, 31

d2 = 30, 31 (d1 ≠ d2)

**TM-J2000/J2100, TM-T90, TM-L90:**

a = 10, 12 (Other than Japanese model)

a = 12, 17, 18 (Japanese model)

**TM-P60: a = 12, 17, 18**

[Description] Copies the data in the user-defined code page.

- Font number is specified by **a**.

<b>a</b>	<b>User defined code page</b>	<b>Number of horizontal dots</b>	<b>Number of vertical dots</b>
10	Font configuration 9 × 14 (page 255)	9	17
12	Font configuration 12 × 24 (page 255)	12	24
17	Font configuration 8 × 16 (page 255)	8	16
18	Font configuration 10 × 24 (page 255)	10	24

- Copy operation is specified by **d1, d2**.

<b>d1</b>	<b>d2</b>	<b>Copy operation</b>
31	30	Copy the font number data ( <b>a</b> ) from the storage area into the work area
30	31	Copy the data from the work area into the storage area specified by font number ( <b>a</b> )

# CONFIDENTIAL

[Notes]

- This function works in user setting mode.
- User defined code pages are page 255 or page 254 in the character code pages of alphanumeric Katakana characters built in the printer. Character data defined in the user-defined code page can be printed by specifying the character code after selecting the page with **ESC t**.
- Work area means RAM area that is used to edit character data.
- Storage area means non-volatile memory area that is used to store page data of user-defined code pages.
- Character data can be specified as follows:

Procedure	Processing	Used function
1	Shifts to the user setting mode	Function 1
2	Copy data from storage area into work area	Function 7 ( <b>d1</b> = 31, <b>d2</b> = 30)
3	Change pattern of the character data	Function 8 or Function 9
4	Copy data from work area into storage area	Function 7 ( <b>1</b> = 30, <b>d2</b> = 31)
5	Exit user setting mode	Function 2

- Character data can be changed in the work area.
- Rewrites the data in the user-defined code page (storage area) by Function 4.
- Function 2 should be executed before defining character data, and Function should be executed after defining character data.
- Specify the same font number in Function 2 and Function 4.

[Model-dependent variations] **TM-J2000/J2100, TM-T90, TM-L90, TM-T88IV, TM-T70, TM-P60, TM-U220**

**TM-J2000/J2100, TM-T90, TM-L90**

**The relation between the font number and code page is as follows:**

**<Other than Japanese models>**

Font No. (configuration)	Code page
<b>10 (9 × 17)</b>	<b>Page 255 of Font B</b>
<b>12 (12 × 24)</b>	<b>Page 255 of Font A</b>

# CONFIDENTIAL

## <Japanese models>

Font No. (configuration)	Code page
12 (12 × 24)	Page 255 of Font A
17 (8 × 16)	Page 255 of Font C
18 (10 × 24)	Page 255 of Font B

**TM-T88IV, TM-T70, TM-U220**

This printer doesn't have this function.

**TM-P60**

The relation between the font number and code page is as follows:

Font No. (configuration)	Code page
12 (12 × 24)	Page 255 of Font A
17 (8 × 16)	Page 255 of Font C
18 (10 × 24)	Page 255 of Font B

## GS ( E *p<sub>L</sub>* *p<sub>H</sub>* *fn* *y* *c1* *c2*[*x* *d1*...*d*(*y* × *x*)] *k* <Function 8>

[Name] Define the data (column format) for the character code page

[Format] ASCII GS ( E **p<sub>L</sub>** **p<sub>H</sub>** **fn** **y** **c1** **c2** [**x** **d1**...**d**(**y** × **x**)]**k**  
 Hex 1D 28 45 **p<sub>L</sub>** **p<sub>H</sub>** **08** **y** **c1** **c2** [**x** **d1**...**d**(**y** × **x**)]**k**  
 Decimal 29 40 69 **p<sub>L</sub>** **p<sub>H</sub>** **8** **y** **c1** **c2** [**x** **d1**...**d**(**y** × **x**)]**k**

[Range]  $5 \leq (\mathbf{p_L} + \mathbf{p_H} \times 256) \leq 65535$  ( $0 \leq \mathbf{p_L} \leq 255, 0 \leq \mathbf{p_H} \leq 255$ )  
**fn** = 8  
 $128 \leq \mathbf{c1} \leq \mathbf{d2} \leq 255$   
 $0 \leq \mathbf{d} \leq 255$   
**k** = **c2** - **c1** + 1

Font No. (configuration)	<b>y</b>	<b>x</b>
10 (9 × 17)	3	9
12 (12 × 24)	3	12
17 (8 × 16)	2	8
18 (10 × 24)	3	10

[Description] Defines the character pattern (column format) for the character code page in the work area.

- **y** specifies the number of bytes in the vertical direction.
- **c1** specifies the beginning character code for the definition, and **c2** specifies the final code.
- **x** specifies the number of dots in the horizontal direction from the left.
- **d** specifies the defined data (column format).
- **k** indicates the number of the defined data. **k** is an explanation parameter; therefore, it does not need to be transmitted.

[Notes]

- This function works in user setting mode.
- Characters in Hexadecimal: 80H to FFH / in Decimal: 128 to 255 in ASCII code can be defined.
- If **y**, **c1**, **c2**, or **x** process a value out of the definition range, processing of this function is canceled.

- Changes the data of the user-defined code page that is copied into the work area by Function 7.
- If data in the user-defined code pages is not copied into the work area, this function is not available. In this case, execute Function 7 first.
- Definition data (**d**) specifies a bit printed to 1 and not printed to 0. The data to define a character is (**y** × **x**) bytes.
- When defining the character of the Font No. 10 (configuration: 9 × 17), only the MSB can be used in the third byte for vertical direction. All bits can be used when defining characters of other fonts.
- Definition data (**d**) defines the **x** dots pattern from the left side of the characters. When **x** is smaller than the number of dots composing the built-in character, any remaining dots on the right side are blank.
- Deletes the character data defined in the same code.
- Function 9 can also define character data. It is recommended that either of the functions be used, even if both functions are supported.
  - Definition area and printing results are the same in both functions, although Function 8 processes the data in column format, and Function 9 processes the data in raster format.
- The relation between the definition data and printing result is as follows.

Example: Characters composed of 24 × 12 dots (**y** = 3, **x** = 12)

<b>d1</b>	<b>d4</b>	<b>d7</b>	...	<b>d28</b>	<b>d31</b>	<b>d34</b>	MSB LSB
<b>d2</b>	<b>d5</b>	<b>d8</b>	...	<b>d29</b>	<b>d32</b>	<b>d35</b>	MSB LSB
<b>d3</b>	<b>d6</b>	<b>d9</b>	...	<b>d30</b>	<b>d33</b>	<b>d36</b>	MSB LSB

[Model-dependent variations]

**TM-T88IV**, **TM-T70**, **TM-P60**, **TM-U220**

**TM-T88IV**, **TM-T70**, **TM-P60**, **TM-U220**

**This printer doesn't support this function.**

## GS ( E *p<sub>L</sub>* *p<sub>H</sub>* *fn* *x* *c1* *c2*[*y* *d1*...*d(x × y)*] *k* <Function 9>

---

[Name] Define the data (raster format) for the character code page

[Format] ASCII GS ( E **p<sub>L</sub>** **p<sub>H</sub>** **fn** **x** **c1** **c2** [**x** **d1**...**d(x × y)**]**k**  
 Hex 1D 28 45 **p<sub>L</sub>** **p<sub>H</sub>** **08** **x** **c1** **c2** [**x** **d1**...**d(x × y)**]**k**  
 Decimal 29 40 69 **p<sub>L</sub>** **p<sub>H</sub>** **8** **x** **c1** **c2** [**x** **d1**...**d(x × y)**]**k**

[Range]  $5 \leq (\mathbf{p_L} + \mathbf{p_H} \times 256) \leq 65535$  ( $0 \leq \mathbf{p_L} \leq 255, 0 \leq \mathbf{p_H} \leq 255$ )

**fn** = 9

$128 \leq \mathbf{c1} \leq \mathbf{d2} \leq 255$

$0 \leq \mathbf{d} \leq 255$

**k** = **c2** - **c1** + 1

Font No. (configuration)	<b>y</b>	<b>x</b>
10 (9 × 17)	2	17
12 (12 × 24)	2	24
17 (8 × 16)	1	16
18 (10 × 24)	2	24

[Description] Defines the character pattern (raster format) for the character code page in the work area.

- **x** specifies the number of bytes in the horizontal direction.
- **c1** specifies the beginning character code for the definition, and **c2** specifies the final code.
- **y** specifies the number of dots in the vertical direction from the top.
- **d** specifies the defined data (raster format).
- **k** indicates the number of the defined data. **k** is an explanation parameter; therefore, it does not need to be transmitted.

- [Notes]
- This function works in user setting mode.
  - Characters in Hexadecimal: 80H to FFH / in Decimal: 128 to 255 in ASCII code can be defined.
  - If **y**, **c1**, **c2**, or **x** process a value out of the definition range, processing of this function is canceled.
  - Changes the data of the user-defined code page that is copied into the work area by Function 7.

- If the data in the user-defined code pages is not copied into the work area, this function is not available. In this case, execute Function 7 first.
- Definition data (**d**) specifies a bit printed to 1 and not printed to 0. The data to define a character is (**x** × **y**) bytes.
- When defining the character of the Font No. 10 (configuration: 9 × 17), only the MSB can be used in the second byte for horizontal direction. When defining the character of the Font No. 12 (configuration: 12 × 24), only the upper four bits can be used in the second byte for horizontal direction. All bits can be used when defining characters of other fonts.
- Definition data (**d**) defines the **y** dots pattern from the top of the characters. When **y** is smaller than the number of dots composing the built-in character, any remaining dots below are blank.
- Deletes the character data defined in the same code.
- Function 8 can also define character data. It is recommended that either of the functions be used even if both functions are supported.
  - Definition area and printing results are the same in both functions, although Function 8 processes the data in column format, and Function 9 processes the data in raster format.
- The relation between the definition data and printing result is as follows.

Example: Characters composed of 24 × 12 dots (**x** = 2, **y** = 24)

The second bytes in the horizontal position use 4 bits of the MSB.

<b>d1</b>	<b>d2</b>
<b>d3</b>	<b>d4</b>
:	:
<b>d45</b>	<b>d46</b>
<b>d47</b>	<b>d48</b>

MSB LSB MSB LSB

[Model-dependent variations]

**TM-T88IV**, **TM-T70**, **TM-U220**

**TM-T88IV**, **TM-T70**, **TM-U220**

**This printer doesn't support this function.**



# CONFIDENTIAL

## GS ( E *pL pH fn c1 c2* <Function 10>

---

[Name]	Delete the data for the character code page
[Format]	ASCII      GS (    E <b>pL pH fn c1 c2</b> Hex        1D 28 45 <b>03 00 0A c1 c2</b> Decimal    29 40 69 <b>3 0 10 c1 c2</b>
[Range]	$(pL + pH \times 256) = 3$ ( <b>pL = 3, pH = 0</b> ) <b>fn = 10</b> $y = 2$ $128 \leq c1 \leq d2 \leq 255$
[Description]	Deletes the character pattern for the character code page in the work area. <ul style="list-style-type: none"><li>• <b>c1</b> specifies the beginning character code for the deletion, and <b>c2</b> specifies the final code.</li></ul>
[Notes]	<ul style="list-style-type: none"><li>■ This function works in user setting mode.</li><li>■ Characters in Hexadecimal: 80H to FFH / Decimal: 128 to 255 in ASCII code can be defined.</li><li>■ After deleting the character pattern, the dots are blank.</li><li>■ Deletes the data of the user-defined code page that is copied into the work area by Function 7.</li><li>■ If data in the user-defined code pages is not copied into the work area, this function is not available. In this case, execute Function 7 first.</li></ul>
[Model-dependent variations]	<b>TM-T88IV</b> , <b>TM-T70</b> , <b>TM-U220</b>

**TM-T88IV**, **TM-T70**, **TM-U220**

**This printer doesn't support this function.**

## GS ( E *pL pH fn a d1...dk* <Function 11>

---

[Name]	Set the configuration item for the serial interface
[Format]	ASCII      GS (    E <b>pL pH fn a d1...dk</b> Hex        1D 28 45 <b>pL pH OB a d1...dk</b> Decimal    29 40 69 <b>pL pH 11 a d1...dk</b>
[Range]	$3 \leq (\mathbf{pL} + \mathbf{pH} \times 256) \leq 8$ ( $3 \leq \mathbf{pL} \leq 8, 0 \leq \mathbf{pH} \leq 255$ ) <b>fn = 11</b> $48 \leq \mathbf{d} \leq 57$ [ <b>a = 1</b> ] $48 \leq \mathbf{d} \leq 50$ [ <b>a = 2</b> ] <b>d = 48, 49</b> [ <b>a = 3</b> ] <b>d = 55, 56</b> [ <b>a = 4</b> ] $1 \leq \mathbf{k} \leq 6$ <b>TM-J2000/J2100, TM-T90, TM-L90, TM-U220: 1 ≤ a ≤ 4</b> <b>TM-T88IV, TM-T70: a = 1</b> <b>TM-P60: a = 1, 2</b>
[Default]	<b>TM-J2000/J2100, TM-T90, TM-L90:</b> <b>d1...dk = "19200" [a = 1]</b> <b>d = 48 [a = 2]</b> <b>d = 48 [a = 3]</b> <b>d = 56 [a = 4]</b> <b>TM-T88IV: d1...dk = "38400" [a = 1]</b> <b>TM-T70: d1...dk = "115200" [a = 1]</b> <b>TM-P60: d1...dk = "9600" [a = 1]</b> <b>d = 48 [a = 2]</b> <b>TM-U220: d1...dk = "9600" [a = 1]</b> <b>d = 48 [a = 2]</b> <b>d = 48 [a = 3]</b> <b>d = 56 [a = 4]</b>

# CONFIDENTIAL

[Description]

Sets the configuration item for the serial interface specified by **a** to the values specified by **d1...dk**.

<b>a</b>	<b>Configuration item</b>
1	Transmission speed
2	Parity
3	Flow control
4	Data length

- Transmission speed (**a** = 1) is specified by number. The baud rate that can be specified differs, depending on the printer model.

Example: When defining 19200 bps: 5 bytes as "19200" (Hexadecimal = 31H, 39H, 32H, 30H, 30H / Decimal = 49, 57, 50, 48, 48)

- Parity (**a** = 2) is specified by **d** as follows:

<b>d</b>	<b>Function</b>
48	Select no parity
49	Select odd parity
50	Select even parity

- Flow control (**a** = 3) is specified by **d** as follows:

<b>d</b>	<b>Function</b>
48	Select Flow control of DTR/DSR
49	Select Flow control of XON/XOFF

- Data length (**a** = 4) is specified by **d** as follows:

<b>d</b>	<b>Function</b>
55	Select 7 bits length
56	Select 8 bits length

[Notes]

- It is recommended that the DIP switch be used to change communication condition.

- If the communication control between host and printer does not correspond, the printer cannot process data from the host normally, and the host cannot receive data from the printer normally.
- This function works in user setting mode.
- This function works with serial interface printers.
- The communication condition set by this function is enabled by executing Function 2 or restarting the printer. It is necessary to change the communication condition of the host to be the same as the printer to communicate with the printer.
- To enable the communication condition set by this function, select “by memory switch” in the DIP switch settings (Interface condition selection).
- Communication conditions set are valid until the following operations are executed. They are not initialized by power off or ESC @.
  - Execution of this function.
  - Execution of memory switch setting mode by panel operation when the power is turned on (supported by some printer models.)

[Model-dependent variations]      **TM-J2000/J2100, TM-T90, TM-L90, TM-T88IV, TM-T70, TM-P60, TM-U220**

## **TM-J2000/J2100, TM-T90, TM-L90**

**DIP switch for setting communication condition is Sw 2. When DIP switch is off, this function is enabled. Turn off the printer before changing DIP switch settings.**

**7 baud rates are selectable.**

**["2400 ", "4800 ", "9600 ", "19200 ", "38400 ", "57600 ", "115200 "]**

**Setting of this function can be changed by “Memory switch setting mode” by the panel switch operation when the power supply is turned on.**

## **TM-T88IV, TM-T70**

**DIP switches for setting communication condition are Sw 1-7 and Sw 1-8. When both DIP switches are ON, this function is enabled. Turn off the printer before changing DIP switch settings.**

**7 baud rates are selectable.**

**["2400 ", "4800 ", "9600 ", "19200 ", "38400 ", "57600 ", "115200 "]**

## TM-P60

DIP switch for setting communication condition is not supported. 3 baud rates are selectable.

["9600 ", "19200 ", "38400 "]

## TM-U220

- The serial communication setting is also specified by DIP switch.
- There are 2 series (types) of this printer. They are identified on a sticker near the DIP switch on the main board. One is "STD," the other is "US." The DIP switch assignment is different between the "STD" series and the "US" series. The DIP switch selects either DIP switch or this function to specify the serial communication setting. The selecting DIP switch is shown in following table. When the DIP switch is ON, a setting value of this function is enabled. Turn off the printer before changing DIP switch settings.

Printer series	DIP switch
Type B, D with "STD" sticker or Type A	[SW 2-4]
Type B, D with "US" sticker	[SW 2-8]

5 baud rates are selectable by this command.

["1200", "2400 ", "4800 ", "9600 ", "19200 "]

Setting of this function can be changed by "Memory switch setting mode" by the panel switch operation.

## GS ( E *pL pH fn a* <Function 12>

---

[Name] Transmit the configuration item for the serial interface

[Format] ASCII GS ( E **pL pH fn a**  
 Hex 1D 28 45 **pL pH OB a**  
 Decimal 29 40 69 **pL pH 11 a**

[Range] (**pL** + **pH** × 256) = 2 (**pL** = 2, **pH** = 0)  
**fn** = 12

**TM-J2000/J2100, TM-T90, TM-L90, TM-U220: 1 ≤ a ≤ 4**

**TM-T88IV, TM-T70: a = 1**

**TM-P60: a = 1, 2**

[Description] Transmits the configuration item for the serial interface specified by **a**.

<b>a</b>	<b>Communication item</b>
1	Transmission speed
2	Parity
3	Flow control
4	Data length

- "ESC/POS transmission handshake" is unnecessary with this function.

[Notes] ■ This function works in user setting mode and during normal operation.

■ This function transmits "Header to NUL" as follows:

<b>Transmit data</b>	<b>Hex</b>	<b>Decimal</b>	<b>Data</b>
Header	37H	55	1 byte
Identifier	33H	51	1 byte
Communication condition (*1)	30H–34H	48–52	1 byte

Separator	1FH	31	1 byte
Setting value (*2)	30H–39H	48–57	1–5 byte
NUL	00H	0	1 byte

(\*1) Communication condition transmits the value of **a** is converted into character data expressed by decimal numbers. Example: When [Communication condition] is the baud rate (**a** = 1), it is 1-byte data of "1" [Hexadecimal = 31H/Decimal = 49].

(\*2) "Setting value" is set by Function 11. It might differ from the current communication condition before executing Function 2 or depending on the setting of the DIP switch. Example: When the baud rate is 9600 bps, it is 4-byte data of "9600" [Hexadecimal = 39H, 36H, 30H, 30H/Decimal = 57, 54, 48, 48].

- This function is used to confirm whether Function 11 ends normally before executing Function 2.
- See previous [Notes for transmission process] for process sending data group.

## GS ( E *pL pH fn a d1...dk* <Function 13>

[Name] Set the configuration item for the Bluetooth interface

[Format] ASCII GS ( E **pL pH fn a d1...dk**  
 Hex 1D 28 45 **pL pH OD a d1...dk**  
 Decimal 29 40 69 **pL pH 12 a d1...dk**

[Range] **TM-P60:**  $6 \leq (pL + pH \times 256) \leq 18$  ( $6 \leq pL \leq 18, pH = 0$ ) [(a = 49)]  
 $3 \leq (pL + pH \times 256) \leq 66$  ( $3 \leq pL \leq 66, pH = 0$ ) [(a = 65)]  
**fn = 13**  
**a = 49, 65**  
 $32 \leq d \leq 255$   
 $4 \leq k \leq 16$  [(a = 49)]  
 $1 \leq k \leq 64$  [(a = 65)]

[Default] **TM-P60:** **d1...dk = "4254"** [a = 49]  
**d1...dk = "TAIYO SPP"** [Default value of (a = 65)]

[Default] Sets the configuration item for the Bluetooth interface specified by **a** to the values specified by **d**.

<b>a</b>	<b>Configuration item</b>
49	Bluetooth passkey
65	Bluetooth device name

- The passkey (**a** = 49) is specified with a character string.  
 Example: If 1234 is specified as the passkey, the string is the 4 bytes "1234" [Hexadecimal = 31H, 32H, 33H, 34H / Decimal = 49, 50, 51, 52].
- The device name (**a** = 64) is specified with a character string.  
 Example: If EPSON is specified as the device name, the string is the 5 bytes "EPSON" [Hexadecimal = 45H, 50H, 53H, 4FH, 4EH / Decimal = 69, 80, 83, 79, 78].

[Notes] ■ Note the following points when changing the communication conditions.



- If the communication conditions between the host and printer no longer match, the printer is no longer able to receive data from the host. Also data sent from the printer cannot be received by the host.
- This function operates in the user setting mode.
- The communication conditions set with this function are valid when <Function 2> of this command is executed. Then the printer operates with the changed communication conditions. If the host is not changed to the same communication conditions, communication is not possible.
- The communication conditions set are valid until the following operations are executed. They are not initialized when the power is turned off or by ESC @.
  - This function is executed.
  - The wireless communication initialization mode is executed using the panel switch when the power is turned on.

[Model-dependent variations] **TM-J2000/J2100, TM-T90, TM-T88IV, TM-T70, TM-L90, TM-P60, TM-U220**

**TM-J2000/J2100, TM-T90, TM-T88IV, TM-T70, TM-L90, TM-U220**

**This function is not supported.**

## **TM-P60**

**This function is enabled with a Bluetooth interface model.**

**If the communication conditions of the Bluetooth interface are changed with this function, always finish the user setting mode with <Function 2> of this command. If you turn off the power or perform reset between executing this function and executing <Function 2>, the Bluetooth interface communication conditions are not changed.**

## GS ( E *pL pH fn a* <Function 14>

[Name] Transmit the configuration item for the Bluetooth interface

[Format] ASCII GS ( E **pL pH fn a**  
 Hex 1D 28 45 02 00 0E **a**  
 Decimal 29 40 69 02 00 14 **a**

[Range] (**pL + pH** × 256) = 2 (**pL** = 2, **pH** = 0)  
**fn** = 14  
**a** = 48, 49, 65

[Description] Transmits the configuration item for the Bluetooth interface specified by **a**.

<b>a</b>	<b>Communication item</b>
48	Bluetooth device address (BD_ADDR)
49	Passkey
50	Device name

- When (**a** = 48, 49) is specified, "ESC/POS transmission handshake" is unnecessary.
- When (**a** = 65) is specified, "ESC/POS transmission handshake" is necessary.

- [Notes]
- This function operates in both the user setting mode and during normal operation.
  - When (**a** = 48, 49) is specified, the following Header to NUL is transmitted.

<b>Transmit data</b>	<b>Hex</b>	<b>Decimal</b>	<b>Data</b>
Header	37H	55	1 byte
Identifier	4AH	74	1 byte
Communication condition (*1)	30H or 31H	48 or 49	1 byte
Setting value (*2)	20H – FFH	32 – 255	1–16 byte
NUL	00H	0	1 byte

(\*1) [Communication condition] transmits parameter (**a**) of this function.

(\*2) [Setting value] indicates the setting value of <Function 13> of this command. The currently operating communication conditions may differ from those before executing <Function 2> of this command.

When (**a** = 48) is specified, the 6-byte value that expresses the 48-bit BD\_ADDR as a hexadecimal is converted to character data and transmitted from the upper digits. Therefore the BD\_ADDR transmission data consists of the 12-byte data [Hexadecimal = 30H to 39H, 41H to 46H / Decimal = 48 to 57, 65 to 70].

When (**a** = 49) is specified, the passkey is transmitted. The passkey consists of 4 to 8 bytes of data.

Example: If [Setting value (BD\_ADDR)] is 00 03 7A 0C B0 82, the string is the 12 bytes "00037A0CB082" [Hexadecimal = 30H, 30H, 30H, 33H, 37H, 41H, 30H, 43H, 42H, 30H, 38H, 32H / Decimal = 48, 48, 48, 51, 55, 65, 48, 67, 66, 48, 56, 50].

If [Setting value (passkey)] is 4254, the string is the 4 bytes "4254" [Hexadecimal = 34H, 32H, 35H, 34H / Decimal = 52, 50, 53, 52].

- When (**a** = 65) is specified, the following Header to NUL is transmitted.

Transmit data	Hex	Decimal	Data
Header	37H	55	1 byte
Identifier	7AH	112	1 byte
Identification status	40H	64	1 byte
Communication condition (*1)	41H	65	1 byte
Setting value (*2)	20H – FFH	32 – 255	1–64 byte
NUL	00H	0	1 byte

(\*1) [Communication condition] transmits parameter (**a**) of this function.

(\*2) [Setting value] indicates the setting value of <Function 13> of this command. The currently operating communication conditions may differ from those before executing <Function 2> of this command.

When (**a** = 65) is specified the device name is transmitted.

Example: If [Setting value (device name)] is EPSON, the string is the 5 bytes "EPSON" [Hexadecimal = 45H, 50H, 53H, 4FH, 4EH / Decimal = 69, 80, 83, 79, 78].

- This function is used to determine whether the settings of <Function 13> have finished normally before <Function 2> of this command.

- For a description of transmission of data groups, see the overall specification "Notes for data group transmission process."
- See [Notes for ESC/POS Handshaking Protocol] for description of ESC/POS Handshaking Protocol.

[Model-dependent variations] **TM-J2000/J2100, TM-T90, TM-T88IV, TM-T70, TM-L90, TM-P60, TM-U220**

**TM-J2000/J2100, TM-T90, TM-T88IV, TM-T70, TM-L90, TM-U220**

**This function is not supported.**

## **TM-P60**

**This function operates with the Bluetooth specification.**

## GS ( E pL pH fn d1 d2 d3 <Function 48>

---

[Name] Delete the paper layout

[Format] ASCII GS ( E pL pH fn d1 d2 d3  
 Hex 1D 28 45 04 00 30 d1 d2 d3  
 Decimal 29 40 69 4 0 48 d1 d2 d3

[Range] (pL + pH × 256) = 4 (pL = 4, pH = 0)  
 fn = 48  
 d1 = 67, d2 = 76, d3 = 82

[Description] Deletes all the setting value for the paper layout (no paper layout is set).

- [Notes]
- This function works in user setting mode.
  - With this command, layout setting values stored in the non-volatile memory are canceled due to one of the following processes:
    - Execution of Function 49 of this command
    - Execution of **GS ( A (m = 64)**
    - Executing “Automatic paper layout setting mode function” by panel operation when turning on the power
    - Recovery from a paper layout error

[Model-dependent variations] **TM-J2000/J2100, TM-T90, TM-T88IV, TM-T70, TM-L90, TM-P60, TM-U220**

**TM-J2000/J2100, TM-T90, TM-T88IV, TM-T70, TM-P60, TM-U220**

**This printer does not support this function.**

### TM-L90

Recovery from a paper layout error can be set the DIP switches below. See the printer information of Function 3 of **GS ( E** for details.

**TM-L90 with Peeler: [Msw8-1] and [Msw8-2]**

**TM-L90 models without Peeler: [Msw8-2]**

# CONFIDENTIAL

## **GS ( E *pL pH fn sa ; sb ; sc ; sd ; se ; sf ; sg ; sh;* <Function 49>**

---

[Name] Set the paper layout

[Format] ASCII GS( E **pL pH fnsa;sb;sc ; sd ; se ; sf ; sg ; sh ;**  
Hex 1D28 45**pL pH 31 sa3Bsb3Bsc3B sd 3B se 3B sf 3B sg 3B sh 3B**  
Decimal 2940 69**pL pH 49sa59sb59sc59 sd 59 se 59 sf 59 sg 59 sh 59**

[Range]  $9 \leq (\mathbf{pL} + \mathbf{pH} \times 256) \leq 36$  ( $9 \leq \mathbf{pL} \leq 36$ ,  $\mathbf{pH} = 0$ )

**fn = 49**

**TM-L90: sa = "48", "49", "64"**

**"135" ≤ sb ≤ "3000"**

**"25" ≤ sc ≤ "100"**

**"0" ≤ sd ≤ "3000"**

**"0" ≤ se ≤ "3000"**

**"38" ≤ sf ≤ "3000"**

**"27" ≤ sg ≤ "507" (sa = "48" or "49")**

**"47" ≤ sg ≤ "507" (sa = "64")**

**"240" ≤ sh ≤ "720" (sa = "48" or "49")**

**"240" ≤ sg ≤ "700" (sa = "64")**

**Some combinations of parameters do not work. See the model-dependent variation section for details.**

[Default] Nothing is set.

[Description] Sets the paper layout (origin of layout, layout in the vertical direction and horizontal direction) in the NV memory.

- Sets the origin of layout by **sa**.

<b>sa</b>	<b>Origin of layout</b>	<b>Paper type</b>
48	None (does not use the layout)	Receipt (without black mark), continuous label
49	Top of a black mark	Paper with black mark
64	Bottom of a label	Label paper (die-cut label)

# CONFIDENTIAL

- Sets the layout in the vertical direction by **(sb)** to **(sf)**. (BM = black mark).

	<b>(sa = 49)</b>	<b>(sa = 64)</b>
<b>sb</b>	Top of a BM ~ top of next BM.	Bottom of a label ~ bottom of the next label.
<b>sc</b>	Top of a BM ~ bottom of BM.	Bottom of a label ~ top of the next label.
<b>sd</b>	Top of a BM ~ print starting position.	Bottom of a label ~ the print starting position.
<b>se</b>	Top of a BM ~ cutting position.	Bottom of a label ~ cutting position.
<b>sf</b>	Print starting position ~ bottom of the print area.	Print starting position ~ bottom of the print area.

- The print starting position set by **sd** is top of the print area.
- The setting unit is 0.1 mm. The relationship between each setting value of the layout of the vertical direction and paper layout is as follows.

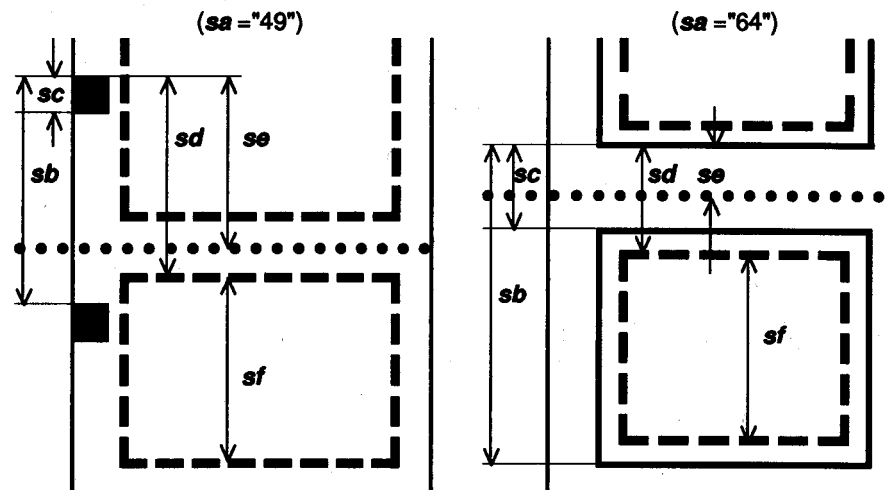

- Sets the layout in the horizontal direction by **sg** or **sh**.

	<b>(sa = 49)</b>	<b>(sa = 64)</b>
<b>sg</b>	Left of the paper ~ left of print area.	Left of the paper ~ left of print area.
<b>sh</b>	Left of the print area ~ right of print area.	Left of the print area ~ right of print area.

# CONFIDENTIAL

- The setting unit is 0.1 mm. The relationship between each setting value of the layout of the vertical direction and paper layout is as follows.

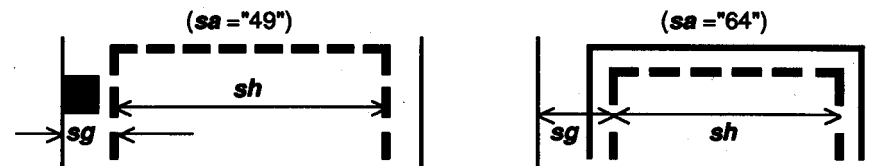

[Notes]

- This function works in user setting mode.
- The origin of layout can be specified by **sa** as follows.

<b>sa = "48"</b>	<b>sa = "49"</b>		<b>sa = "64"</b>
	(Type A)	(Type B)	

- When Type B paper specified by **sa** = 49 is used or **sa** = 64, notice the setting of print area and cutting position as follows.
  - Specify **sd**, **sf**, **sg**, **sh** so that the print area is on a label area. Don't specify print area on the liner (backing paper).
  - Specify **se** so that the cutting position is on the liner (backing paper). Don't specify the cutting position on a label area.
- Specify **sa** ~ **sh** are converted to character codes corresponding to decimal data, then transmitted from the MSB. (Example: When specifying 120, data is "120" (in decimal: 49, 50, 48; it is 3 byte).)
- When you don't change the origin of layout that is specified, **sa** can be omitted. However, ";" cannot be omitted even if the parameter is omitted.  
Example (**sa** is omitted): **GS ( E pl ph fn ; sb ; sc ; sd ; se ; sf ; sg ; sh ;**



- In any of the following cases, the parameter after **sb** can be omitted. However, ";" cannot be omitted even if the parameter is omitted.
  - When the origin of layout is "paper layout is not used" (**sa** = 48).
  - When the origin of layout (**sa**) is omitted.
  - When the origin of layout is the same type as currently specified origin of layout.  
Example (**sb, sc, sg, sh** is omitted): **GS ( E pl ph fn a ; ; ; sd ; se ; sf ; ; ;**
- When "paper layout is not used" is specified as the origin of layout (**sa** = 48), the setting value of the layout of vertical and horizontal direction is "nothing is set" even if you make those settings with the parameter after **sb**. ";" cannot be omitted even if the parameter is omitted.
- The effective value used in the actual print operation is calculated based on the setting value of this function, paper width, limited value of the mechanical structure (mechanical pitch or position of print head and so on). The setting value and effective value can be acquired by Function 50.
- When you replace roll paper with a new one with another layout, set the new paper layout with this function:
  - When the power is turned on, including recover from resetting, or the roll paper cover is closed, the printer performs as if the origin of the layout is "none." (The setting in NV memory is not overwritten.)
  - When printing or paper feeding is being processed, a "paper layout error" occurs. Details of the paper layout error vary depending on the models.
- Paper layout set is valid until the following operations are executed. They are not initialized by power off or ESC @.
  - Execution of this function or function 48.
  - Execution of **GS ( A (m = 48)**
  - Execution of automatic setting mode of paper layout by panel operation when the power is turned on.

[Model-dependent variations] **TM-J2000/J2100, TM-T90, TM-T88IV, TM-T70, TM-L90, TM-P60, TM-U220**

**TM-J2000/J2100, TM-T90, TM-T88IV, TM-T70, TM-P60, TM-U220**

**This printer does not support this function.**

## TM-L90

In the following cases, the parameter is the wrong value. If these parameters are processed, the value is not set.

When  $sa = "49"$

$sb \leq sd$

$sb \leq se$

$sb < sf$

width of paper  $< sg + sh + 33$

(when width of paper is less than or  
78 mm {3.1 inches})

width of paper  $< sg + sh + 43$

(when width of paper is less than or  
79 mm {3.1 inches})

width of paper  $< sg + sh + 53$

(when width of paper is less than or  
80 mm {3.1 inches})

When  $sa = "64"$

$sd < sc$

$sc \leq se$

$sb < sg + sf$

width of paper  $< sg + sh + 53$

Take the following into consideration if die-cut labels are used:

The cutting position  $se$  must be set between the labels. It is also recommended to cut the label as far as possible from the top or the bottom of the label.

The print position ( $sd$ ,  $sf$ ) (top and bottom margin) must be set over 1.5 mm from the top and the bottom of the label.

The print position ( $sg$ ,  $sh$ ) (left and right margin) must be set over 2.8 mm from the left and the right of the label.

If the distance between the cutting position and the next print starting position is set to 3.6 mm or less, the printer cannot perform feeding in reverse to set the print starting position on the current label during standby at label peeling position.

When “bottom of a label” is specified as layout of origin ( $sa = 64$ ), paper layout error occurs in any of the following states:

- When the top of the label is detected by performing paper feed less than “setting value of  $sc - 1$  mm”, after passing the origin of layout.
- When the next origin of layout is not detected by performing paper feed “setting value of  $sb \times 1.12$ ,” after passing the origin of layout.
- When the next origin of layout is detected by performing paper feed less than “setting value of  $sb \times 0.88$ ,” after passing top of the label.
- When the next origin of layout is not detected by performing paper feed “setting value of  $sb \times 1.12$ ,” after passing top of the label.

When “top of a black mark” is specified as the origin of layout ( $sa = 49$ ), paper layout error occurs in either of the following states:

- When the bottom of the black mark is detected by performing paper feed less than “setting value of  $sc - 1$  mm”, after passing the origin of layout.
- When the next origin of layout is not detected by performing paper feed “setting value of  $sb \times 1.12$ ,” after passing the origin of layout.
- When the next origin of layout is detected by performing paper feed less than “setting value of  $sb \times 0.88$ ,” after passing top of the print area.
- When the next origin of layout is not detected by performing paper feed “setting value of  $sb \times 1.12$ ,” after passing top of the print area.
- Paper layout setting value can be changed in the automatic setting mode of paper layout by panel operation when the printer power is turned on. However if paper to be used is a label (with a black mark), the automatic setting mode cannot be used. Paper layout needs to be set by this function.
- Recovery from a paper layout error can be set with the DIP switches below. See the printer information of Function 3 of **GS ( E** for details.  
**TM-L90** with Peeler: [Msw8-1] and [Msw8-2]  
**TM-L90** models without Peeler: [Msw8-2]

## GS ( E *pL pH fn n* <Function 50>

---

[Name] Transmit the paper layout information

[Format] ASCII GS ( E **pL pH fn n**  
 Hex 1D 28 45 **02 00 32 n**  
 Decimal 29 40 69 **2 0 50 n**

[Range] (**pL + pH** × 256) = 2 (**pL** = 2, **pH** = 0)  
**fn** = 50  
**n** = 64, 80

[Description] Transmits the paper layout information specified by **n**.

<b>n</b>	<b>Paper layout information</b>
64	Setting value of the paper layout (unit: 0.1 mm {0.004"})
80	Actual value of the paper layout (unit: dot)

- "ESC/POS transmission handshake" is unnecessary with this function.

[Notes] ■ This function works in user setting mode and standard mode.

■ [Header to NUL] are transmitted by this function as follows.

Transmit data	Hex	Decimal	Data
Header	37H	55	1 byte
Identifier	39H	57	1 byte
Type of information (*1)	30H ~ 39 H	48 ~ 57	2 bytes
Separator	1FH	31	1 byte
Layout information (*2)			
Origin of layout (sa)	30H ~ 39H	48 ~ 57	0 ~ 3 bytes
Separator	1FH	31	1 byte
Vertical layout (sb)	30H ~ 39H	48 ~ 57	0 ~ 5 bytes
Separator	1FH	31	1 byte
Vertical layout (sc)	30H ~ 39H	48 ~ 57	0 ~ 5 bytes
Separator	1FH	31	1 byte
Vertical layout (sd)	30H ~ 39H	48 ~ 57	0 ~ 5 bytes
Separator	1FH	31	1 byte
Vertical layout (se)	30H ~ 39H	48 ~ 57	0 ~ 5 bytes
Separator	1FH	31	1 byte
Vertical layout (sf)	30H ~ 39H	48 ~ 57	0 ~ 5 bytes
Separator	1FH	31	1 byte
Horizontal layout (sg)	30H ~ 39H	48 ~ 57	0 ~ 5 bytes
Separator	1FH	31	1 byte
Horizontal layout (sh)	30H ~ 39H	48 ~ 57	0 ~ 5 bytes
Separator	1FH	31	1 byte
NUL	00H	0	1 byte

(\*1) "Type of information" transmits the value **n** converted into character data expressed by decimal numbers from the high order end. Example: When the setting of "Type of information" is (**n** = 64), it is 2-byte data of "64" [Hexadecimal = 36H, 34H/Decimal = 54, 52]. When the setting of "Type of information" is (**n** = 80), it is 2-byte data of "80" [Hexadecimal = 38H, 30H/Decimal = 56, 48].

(\*2) "Layout information" is transmitted sequentially, converting the character data into decimal data. Example: When "Layout basis" is "64," it is 2-byte of "64" [Hexadecimal = 36H, 34H/Decimal = 54, 52]

Type of information ( <b>n</b> )	Transmit data		
	Hex	Decimal	Data
Setting value ( <b>n</b> = 64)	36H, 34H	54, 52	2 bytes
Effect value ( <b>n</b> = 80)	38H, 30H	56, 48	2 bytes

- Setting value (**n** = 64) is specified as the type of information, transmit data are as follows:
  - (**sa** ~ **sh**) of the layout information corresponds to (**sa**) and (**sb**) ~ (**sh**) of Function 49.
  - "Setting value" means the paper layout information: setting value of Function 49 and **GS ( A ( m = 64)**, stored in the non-volatile memory.
  - The paper layout information that is not stored in non-volatile memory cannot be transmitted. In this case, only the separator is transmitted.
- Transmit data when effect value is specified (**n** = 80) as the type of information are as follows:
  - (**sa** ~ **sh**) of the layout information corresponds to (**sa**) of Function 49 and each element (**sb**) ~ (**sh**) of vertical and horizontal layout illustrated in the Function 49.
  - "Effect value" means the value used in actual operation, calculated based on the following values (in one dot units.)
    - Paper layout information (setting value of Function 49 and **GS ( A (auto set of the paper layout)**), stored in the non-volatile memory.
    - Setting value of the paper width.
    - Regulated value by the mechanical structure (minimum pitch, left and right margin of the print area).
    - The paper layout information that is not used in actual print operation cannot be transmitted. In this case, only the separator is transmitted.

# CONFIDENTIAL

- The relationship between setting value of vertical layout (**sg**) and effect value is as follows.

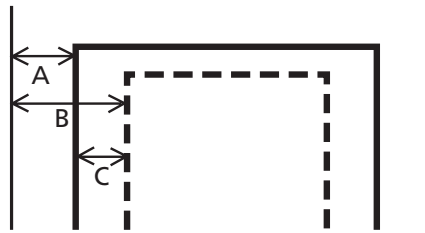

A = Edge of the paper ~ left edge of the printable area  
B = Setting value of paper layout (**sg**)  
C = Effective value (A-B) of paper layout (**sg**)

- See previous [Notes for transmission process] for process of sending data group.

[Model-dependent variations] **TM-J2000/J2100**, **TM-T90**, **TM-T88IV**, **TM-T70**, **TM-P60**, **TM-U220**

**TM-J2000/J2100**, **TM-T90**, **TM-T88IV**, **TM-T70**, **TM-P60**, **TM-U220**

**This printer does not support this function.**

[Name] Customize printer control value(s)

[Printers not featuring this command] **TM-T88IV**, **TM-T70**, **TM-U230**, **TM-U220**

[Description] Customizes the printer control value(s).

- Function code (**fn**) specifies the function.

<b>fn</b>	<b>Function No.</b>	<b>Function name</b>
1, 49	<b>Function 1</b>	Save the setting values from the work area into the storage area.
2, 50	<b>Function 2</b>	Load the setting values stored in the storage area to the work area.
3, 51	<b>Function 3</b>	Select the setting values loaded to the work area after the initialization process.

- **pl**, **ph** specifies (**pl** + **ph** × 256) as the number of bytes after **ph** (**fn** and **m**). In each function **m** is described.

### [Notes]

- The function of this command is determined by the function code (**fn**). Operation differs, depending on the functions.
- Setting value means the values stored in the work area. They are set by commands such as line spacing, print area, or ASB function specification commands; are defined data such as user-defined data or 2-byte characters; and are the setting status such as Kanji mode. The values are different, depending on the printer models. See the model-dependent information.
- Work area means the area that stores the values and is cleared when the power is turned off. The printer's actions are based on the values in the work area.
- Storage area means non-volatile memory area that is used to accomplish the functions of this command. The values stored in the storage area are not cleared when power is turned off. The values in the storage area do not affect the printer operation.
- A default value for each command is stored in the storage area when the printer is shipped.
- The values stored in the storage area are loaded to the work area when Function 1 is executed or when an autoload specified by Function 3 is initialized. These values affect the printer's operation afterward.



- The combination of Functions 2 and 3 can change the default value of each command.
- Function 1 or Function 3 processes writing in a non-volatile memory. Take the following into account when using the function.
  - Do not turn off the power or reset the printer from the interface when the relevant functions are being executed.
  - The printer might be BUSY. In this case, be sure not to send a command from the host because the printer will not receive the data.
  - Excessive use of this function may destroy the non-volatile memory. As a guideline, do not use any combination of the following commands more than 10 times per day for writing data to the non-volatile memory: **GS ( A** (part of functions), **FS q**, **GS ( C** (part of functions), **GS ( E** (part of functions), **GS ( L** (part of functions), **GS ( M** (part of functions), **GS g 0**, **FS g 1**, **FS q**.
- Note the rules below for the operating NV memory (store data / cancel data):
  - Paper feeding is disabled by the paper feed button.
  - The printer does not process real-time commands.
  - Even if "ASB is enabled" is specified, the printer does not send ASB status.

[Model-dependent variations]

**TM-J2000/J2100, TM-T90, TM-L90, TM-P60**

### Program Example 1

```

PRINT #1, CHR$(&H1D); "L";CHR$(24);CHR$(0);←Set left margin
PRINT #1, CHR$(&H1D); "W";CHR$(104);CHR$(1);←Print area width (30 columns)
PRINT #1, CHR$(&H1D); " (M";CHR$(2);CHR$(0);CHR$(1);CHR$(1);←<Function 1>
PRINT #1, "AAAAAAAAAAAAAAAAAAAA"; CHR$(&HA);←Execute 20-column printing
PRINT #1, CHR$(&H1D); "L";CHR$(0);CHR$(0);←Set left margin
PRINT #1, CHR$(&H1D); "W";CHR$(120);CHR$(0);←Print area width (10 columns)
PRINT #1, "BBBBBBBBBBBBBBBBBBBB"; CHR$(&HA);←Execute 20-column printing
PRINT #1, CHR$(&H1D); " (M";CHR$(2);CHR$(0);CHR$(2);CHR$(1);←<Function 2>
PRINT #1, "CCCCCCCCCCCCCCCCCCCC"; CHR$(&HC); ←Execute 20-column printing
    
```

### Print Sample 1

```

AAAAAAAAAAAAAAAAAAAA
BBBBBBBBBB
BBBBBBBBBB
CCCCCCCCCCCCCCCCCCCC
    
```

## Program Example 2

```

PRINT #1, CHR$(&H1D);"L";CHR$(24);CHR$(0);←Set left margin
PRINT #1, CHR$(&H1D);"W";CHR$(104);CHR$(1);←Print area width (30 columns)
PRINT #1, CHR$(&H1D);" (M";CHR$(2);CHR$(0);CHR$(1);CHR$(1);←<Function 1>
PRINT #1, CHR$(&H1D);" (M";CHR$(2);CHR$(0);CHR$(3);CHR$(1);←<Function 3>
PRINT #1, CHR$(&H1D);"L";CHR$(0);CHR$(0);←Set left margin
PRINT #1, CHR$(&H1D);"W";CHR$(120);CHR$(0);←Print area width (10 columns)
PRINT #1, "AAAAAAAAAAAAAAAAAAAA"; CHR$(&HA);←Execute 20-column printing
PRINT #1, CHR$(&H1B);"@";←Initialize printer
PRINT #1, "BBBBBBBBBBBBBBBBBBBB"; CHR$(&HA);←Execute 20-column printing
    
```

## Print Sample 2

```

AAAAAAAAAA
AAAAAAAAAA
      BBBBBBBBBBBBBBBBBBBB
    
```

### TM-J2000/J2100

**GS ( M affects the following commands:**

Category of function	Command
Line spacing	<b>ESC 2, ESC 3</b>
Print character	<b>ESC SP, ESC !, ESC -, ESC E, ESC G, ESC M, ESC R, ESC V, ESC r, ESC t, ESC {, GS !, GS ( N, GS B, GS b</b>
Panel switch	<b>ESC c 5</b>
Paper sensor	<b>ESC c 3, ESC c 4</b>
Print position	<b>ESC D, ESC T, ESC a, GS L, GS W</b>
Bit image	<b>FS ( L Function 49</b>
Status	<b>GS j, GS a</b>
Bar code	<b>GS H, GS f, GS h, GS w</b>
Macro function	<b>GS :</b>
Mech control	<b>ESC U</b>
Kanji control	<b>FS !, FS &amp;, FS ( A, FS -, FS ., FS C, FS S, FS W</b>
Miscellaneous function	<b>GS ( D, GS ( K, GS P</b>

# CONFIDENTIAL

## TM-T90

**GS ( M** affects the following commands:

Category of function	Command
Line spacing	<b>ESC 2, ESC 3</b>
Print character	<b>ESC SP, ESC !, ESC -, ESC E, ESC G, ESC M, ESC R, ESC V, ESC t, ESC {, GS !,GS ( N, GS B, GS b</b>
Panel switch	<b>ESC c 5</b>
Paper sensor	<b>ESC c 3, ESC c 4</b>
Print position	<b>ESC D, ESC T, ESC a, GS L, GS W</b>
Status	<b>GS a</b>
Bar code	<b>GS H, GS f, GS h, GS w</b>
Two dimensions code	<b>GS (k Function 065 to 070</b>
Macro function	<b>GS :</b>
Kanji control	<b>FS !, FS &amp;, FS ( A, FS -, FS ., FS C, FS S, FS W</b>
Miscellaneous function	<b>GS ( D, GS ( H &lt;Function 49&gt;, GS P</b>

## TM-L90

**GS ( M** affects the following commands:

Setting value	Command
Line spacing	<b>ESC 2, ESC 3</b>
Print character	<b>ESC SP, ESC !, ESC -, ESC E, ESC G, ESC M, ESC R, ESC V, ESC t, ESC {, GS !,GS ( N, GS B, GS b</b>
Panel switch	<b>ESC c 5</b>
Paper sensor	<b>ESC c 3, ESC c 4</b>
Print position	<b>ESC D, ESC T, ESC a, GS L, GS W</b>
Status	<b>GS a</b>

Setting value	Command
Bar code	<b>GS H, GS f, GS h, GS w</b>
Two dimensions code	<b>GS ( k Function 065 to 070, 165, 167, 169, 265</b>
Macro function	<b>GS :</b>
Kanji control	<b>FS !, FS &amp;, FS ( A, FS -, FS ., FS 2, FS C, FS S, FS W</b>
Miscellaneous function	<b>GS ( D, Function 49 of GS ( H, GS P, GS z 0</b>

## TM-P60

**GS ( M** affects the following commands:

Category of function	Command
Line spacing	<b>ESC 3</b>
Print character	<b>ESC SP, ESC -, ESC E, ESC M, ESC R, ESC t, ESC {, GS !, GS B, GS b</b>
Print paper	<b>FS (L &lt;Function 33&gt; &lt;Function 80&gt;</b>
Panel switch	<b>ESC c 5</b>
Print position	<b>ESC D, ESC T, ESC a, GS L, GS W</b>
Status	<b>GS a</b>
Bar code	<b>GS H, GS f, GS h, GS w</b>
Two dimension code	<b>GS (k &lt;Function 065 ~ 070&gt; &lt;Function 165&gt; &lt;Function 167&gt; &lt;Function 169&gt; &lt;Function 265&gt; &lt;Function 367&gt; &lt;Function 371&gt; &lt;Function 467&gt; &lt;Function 471&gt; &lt;Function 472&gt;</b>
Kanji control	<b>FS !, FS &amp;, FS ( A, FS -, FS ., FS 2, FS C, FS S, FS W</b>
Miscellaneous function	<b>GS ( D, GS ( K &lt;Function 48&gt;</b>

## GS ( M pL pH fn m <Function 1>

---

[Name]	Save the setting values from the work area into the storage area																					
[Format]	<table> <tr> <td>ASCII</td> <td>GS (</td> <td>M</td> <td>pL</td> <td>pH</td> <td>fn</td> <td>m</td> </tr> <tr> <td>Hex</td> <td>1D 28 4D</td> <td>02</td> <td>00</td> <td>fn</td> <td>m</td> <td></td> </tr> <tr> <td>Decimal</td> <td>29 40 77</td> <td>2</td> <td>0</td> <td>fn</td> <td>m</td> <td></td> </tr> </table>	ASCII	GS (	M	pL	pH	fn	m	Hex	1D 28 4D	02	00	fn	m		Decimal	29 40 77	2	0	fn	m	
ASCII	GS (	M	pL	pH	fn	m																
Hex	1D 28 4D	02	00	fn	m																	
Decimal	29 40 77	2	0	fn	m																	
[Range]	<p><b>(pL + pH × 256) = 2, (pL = 2, pH = 0), fn = 1, 49</b>  <b>TM-J2000/J2100, TM-T90, TM-L90, TM-P60: m = 1, 49</b></p>																					
[Description]	Saves the setting values of commands listed in the tables on the previous pages and stored in the work area in the storage area specified by <b>m</b> .																					
[Notes]	<ul style="list-style-type: none"> <li>■ The values that have been already stored in the storage area specified by <b>m</b> are cleared by this command.</li> <li>■ The values in the work area are not changed.</li> <li>■ The values saved in the storage area are loaded to the work area by the following:             <ul style="list-style-type: none"> <li>• Executed by Function 2 with the storage area specified.</li> <li>• Initialized when an autoload process has been specified by Function 3.</li> </ul> </li> <li>■ The values affected by this command are different, depending on the printer models. See model-dependent variations for details.</li> <li>■ When multiple applications use the storage area at the same time, if this command is executed, the values saved by other applications are deleted. Be sure to take this into account when using this command.</li> </ul>																					

## GS ( M pL pH fn m <Function 2>

---

[Name]	Load the setting values stored in the storage area to the work area																					
[Format]	<table border="0"> <tr> <td>ASCII</td> <td>GS (</td> <td>M</td> <td><b>pL</b></td> <td><b>pH</b></td> <td><b>fn</b></td> <td><b>m</b></td> </tr> <tr> <td>Hex</td> <td>1D 28 4D</td> <td><b>02</b></td> <td><b>00</b></td> <td><b>fn</b></td> <td><b>m</b></td> <td></td> </tr> <tr> <td>Decimal</td> <td>29 40 77</td> <td><b>2</b></td> <td><b>0</b></td> <td><b>fn</b></td> <td><b>m</b></td> <td></td> </tr> </table>	ASCII	GS (	M	<b>pL</b>	<b>pH</b>	<b>fn</b>	<b>m</b>	Hex	1D 28 4D	<b>02</b>	<b>00</b>	<b>fn</b>	<b>m</b>		Decimal	29 40 77	<b>2</b>	<b>0</b>	<b>fn</b>	<b>m</b>	
ASCII	GS (	M	<b>pL</b>	<b>pH</b>	<b>fn</b>	<b>m</b>																
Hex	1D 28 4D	<b>02</b>	<b>00</b>	<b>fn</b>	<b>m</b>																	
Decimal	29 40 77	<b>2</b>	<b>0</b>	<b>fn</b>	<b>m</b>																	
[Range]	<p><b>(pL + pH × 256) = 2, (pL = 2, pH = 0), fn = 2, 50</b>  <b>TM-J2000/J2100, TM-T90, TM-L90, TM-P60: m = 0,1, 48, 49</b></p>																					
[Description]	<p>Loads the command setting values stored in the storage area specified by <b>m</b> to the work area.</p> <ul style="list-style-type: none"> <li>• When <b>m = 0, 48</b>, the default values described in this guide are applied.</li> <li>• When <b>m ≠ 0, 48</b>, the setting values are stored in the storage area specified by <b>m</b>.</li> </ul>																					
[Notes]	<ul style="list-style-type: none"> <li>■ This function is effective at the beginning of a line in standard mode.</li> <li>■ This function cannot be included in a macro. Do not use this function when executing a macro.</li> <li>■ The value in the work area is set to the default value by the following: <ul style="list-style-type: none"> <li>• Executing this function by specifying <b>m = 0, 48</b>.</li> <li>• Executing Function 2 with the condition that the storage area that has not executed Function 1 is specified.</li> <li>• Initializing when an autoloader process has been canceled by Function 3.</li> </ul> </li> <li>■ The values in the work area that are not affected by this command are not changed.</li> <li>■ The values in the storage area are not changed.</li> <li>■ The values affected by this command are different, depending on the printer models. See model-dependent variations for details.</li> </ul>																					

## GS ( M p<sub>L</sub> p<sub>H</sub> fn m <Function 3>

---

[Name]	Select the setting values loaded to the work area after the initialization process																					
[Format]	<table border="0"> <tr> <td>ASCII</td> <td>GS (</td> <td>M</td> <td><b>p<sub>L</sub></b></td> <td><b>p<sub>H</sub></b></td> <td><b>fn</b></td> <td><b>m</b></td> </tr> <tr> <td>Hex</td> <td>1D 28 4D</td> <td><b>02</b></td> <td><b>00</b></td> <td><b>fn</b></td> <td><b>m</b></td> <td></td> </tr> <tr> <td>Decimal</td> <td>29 40 77</td> <td><b>2</b></td> <td><b>0</b></td> <td><b>fn</b></td> <td><b>m</b></td> <td></td> </tr> </table>	ASCII	GS (	M	<b>p<sub>L</sub></b>	<b>p<sub>H</sub></b>	<b>fn</b>	<b>m</b>	Hex	1D 28 4D	<b>02</b>	<b>00</b>	<b>fn</b>	<b>m</b>		Decimal	29 40 77	<b>2</b>	<b>0</b>	<b>fn</b>	<b>m</b>	
ASCII	GS (	M	<b>p<sub>L</sub></b>	<b>p<sub>H</sub></b>	<b>fn</b>	<b>m</b>																
Hex	1D 28 4D	<b>02</b>	<b>00</b>	<b>fn</b>	<b>m</b>																	
Decimal	29 40 77	<b>2</b>	<b>0</b>	<b>fn</b>	<b>m</b>																	
[Range]	<p><b>(p<sub>L</sub> + p<sub>H</sub> × 256) = 2, (p<sub>L</sub> = 2, p<sub>H</sub> = 0), fn = 3, 51</b>  <b>TM-J2000/J2100, TM-T90, TM-L90, TM-P60: m = 0,1, 48, 49</b></p>																					
[Default]	<b>m = 0</b>																					
[Description]	<p>Selects the command setting values loaded to the work area after the printer performs the initialization process.</p> <ul style="list-style-type: none"> <li>• When <b>m = 0, 48</b>, the default values described in this guide are applied.</li> <li>• When <b>m ≠ 0, 48</b>, the setting values are stored in the storage area specified by <b>m</b>.</li> </ul>																					
[Notes]	<ul style="list-style-type: none"> <li>■ This function does not change the values in the work area and storage area.</li> <li>■ The setting of this function affects the following initializations. <ul style="list-style-type: none"> <li>• Turning on the power.</li> <li>• Resetting the hardware by using a reset terminal.</li> <li>• Executing <b>ESC @</b>.</li> <li>• Executing a software reset.</li> </ul> </li> <li>■ The specification of this function is maintained after turning off the power.</li> <li>■ In autoload processing, the values of the commands that are in the work area and are not affected by this function and the values in the storage area are not changed.</li> <li>■ The values affected by autoload processing of this function are different, depending on the printer models. See model-dependent variations for details.</li> </ul>																					

## COUNTER PRINTING COMMANDS

---

Command	Name
---------	------

<b>GS C 0</b>	Select counter print mode
<b>GS C 1</b>	Select count mode (A)
<b>GS C 2</b>	Set counter
<b>GS C ;</b>	Select counter mode (B)
<b>GS c</b>	Print counter



[Name] Select counter print mode

[Format]

ASCII	GS	C	0	<b>n</b>	<b>m</b>
Hex	1D	43	30	<b>n</b>	<b>m</b>
Decimal	29	67	48	<b>n</b>	<b>m</b>

[Range]

$0 \leq n \leq 5$   
 $0 \leq m \leq 2, 48 \leq m \leq 50$

[Default] **n** = 0, **m** = 0

[Printers not featuring this command] **TM-J2000/J2100**, **TM-T90**, **TM-T88IV**, **TM-T70**, **TM-P60**, **TM-U230**, **TM-U220**

[Description] Selects the print format for the serial number counter value (the number of printed digits and the print position within the entire range of printed digits).

- **n** specifies the number of digits to be printed.

<b>n</b>	<b>Function</b>
0	Prints the actual digits indicated by the number value.
1-5	Prints the last <b>n</b> digits of the serial number.

- **m** specifies the layout within the specified range of printed digits, as follows:

<b>m</b>	<b>Justification</b>	<b>Layout within digits less than those specified</b>
0, 48	Align right	Adds spaces to the left if the digits are less than those specified.
1, 49	Align right	Adds 0 to the left if the digits are less than those specified.
2, 50	Align left	Adds spaces to the right if the digits are less than those specified.

[Recommended Functions]

This command is supported by some printer models but may not be supported by future models. Future models will not support counter value.

# CONFIDENTIAL

- [Notes]
- The serial number counter is stored in the print buffer by **GS c**.
  - Settings of this command are effective until **ESC @** is executed, the printer is reset, or the power is turned off.

## Program Example

```
PRINT #1, CHR$(&H1D); "C0";CHR$(3);CHR$(0);  
PRINT #1, "AAAAA";CHR$(&H1D); "c";CHR$(&HA);  
PRINT #1, CHR$(&H1D); "C0";CHR$(4);CHR$(1);  
PRINT #1, "BBBBB";CHR$(&H1D); "c";CHR$(&HA);
```

## Print Sample

```
AAAAA 1 ←3 digits + right alignment + adding spaces to the left  
BBBBB0002 ←4 digits + right alignment + adding "0" to the left
```

[Name] Select count mode (A)

[Format] ASCII GS C 1 **aL aH bL bH n r**  
 Hex 1D 43 31 **aL aH bL bH n r**  
 Decimal 29 67 49 **aL aH bL bH n r**

[Range]  $0 \leq (\mathbf{aL} + \mathbf{aH} \times 256) \leq 65535$  ( $0 \leq \mathbf{aL} \leq 255, 0 \leq \mathbf{aH} \leq 255$ )  
 $0 \leq (\mathbf{bL} + \mathbf{bH} \times 256) \leq 65535$  ( $0 \leq \mathbf{bL} \leq 255, 0 \leq \mathbf{bH} \leq 255$ )  
 $0 \leq \mathbf{n} \leq 255, 0 \leq \mathbf{r} \leq 255$

[Default]  $(\mathbf{aL} + \mathbf{aH} \times 256) = 1$  ( $\mathbf{aL} = 1, \mathbf{aH} = 0$ )  
 $(\mathbf{bL} + \mathbf{bH} \times 256) = 65535$  ( $\mathbf{bL} = 255, \mathbf{bH} = 255$ )  
 $\mathbf{n} = 1, \mathbf{r} = 1$

[Printers not featuring this command] **TM-J2000/J2100, TM-T90, TM-T88IV, TM-T70, TM-P60, TM-U230, TM-U220**

[Description] Sets the serial number counter range, the stepping amount, and the repetition number.

Count mode	Parameters	Counter range	
		Minimum value	Maximum value
Count-up	$\mathbf{aL} + \mathbf{aH} \times 256 < \mathbf{bL} + \mathbf{bH} \times 256$ and $\mathbf{n} \neq 0$ and $\mathbf{r} \neq 0$	$\mathbf{aL} + \mathbf{aH} \times 256$	$\mathbf{bL} + \mathbf{bH} \times 256$
Count-down	$\mathbf{aL} + \mathbf{aH} \times 256 > \mathbf{bL} + \mathbf{bH} \times 256$ and $\mathbf{n} \neq 0$ and $\mathbf{r} \neq 0$	$\mathbf{bL} + \mathbf{bH} \times 256$	$\mathbf{aL} + \mathbf{aH} \times 256$
Count-stop	$\mathbf{aL} + \mathbf{aH} \times 256 = \mathbf{bL} + \mathbf{bH} \times 256$ or $\mathbf{n} = 0$ or $\mathbf{r} = 0$	—	—

- **aL, aH** and **bL, bH** specify the serial number counter ranges (maximum or minimum value).
- **n** specifies the stepping amount for counting up or down.
- **r** specifies the repetition number with the counter value.

[Recommended Functions]

This command is supported by some of the printer models and will not be supported by future models. Future models will not support counter value.

- [Notes]
- When this command is executed, the internal counter which counts the repetition number of printing is 0.
  - This command does not change the counter value. The counter value is set by **GS C 2**.

- The value of the counter is updated when executing **GS c** by following the counter mode set by this command.
- In a count-up setting, when the **GS c** is executed and the counter value exceeds the maximum value (**bl** + **bh** × 256), counting is restarted from the minimum value (**al** + **ah** × 256).
- In a count-down setting, when **GS c** is executed, the counter value is below minimum value (**bl** + **bh** × 256), restart counting from the maximum value (**al** + **ah** × 256).
- In a count-stop setting, when executing **GS c**, the counter value is not changed.
- The settings for a range of a counter set by **GS C ;**, stepping amount of incrementing or decrementing of a counter value, the repetition number of printing is disabled by processing this command.
- Settings of this command are effective until **GS C ;** is executed, **ESC @** is executed, the printer is reset, or the power is turned off.

[Name]	Set counter																		
[Format]	<table border="0"> <tr> <td>ASCII</td> <td>GS</td> <td>C</td> <td>2</td> <td><b>nL</b></td> <td><b>nH</b></td> </tr> <tr> <td>Hex</td> <td>1D</td> <td>43</td> <td>32</td> <td><b>nL</b></td> <td><b>nH</b></td> </tr> <tr> <td>Decimal</td> <td>29</td> <td>67</td> <td>50</td> <td><b>nL</b></td> <td><b>nH</b></td> </tr> </table>	ASCII	GS	C	2	<b>nL</b>	<b>nH</b>	Hex	1D	43	32	<b>nL</b>	<b>nH</b>	Decimal	29	67	50	<b>nL</b>	<b>nH</b>
ASCII	GS	C	2	<b>nL</b>	<b>nH</b>														
Hex	1D	43	32	<b>nL</b>	<b>nH</b>														
Decimal	29	67	50	<b>nL</b>	<b>nH</b>														
[Range]	$0 \leq (\mathbf{nL} + \mathbf{nH} \times 256) \leq 65535$ ( $0 \leq \mathbf{nL} \leq 255, 0 \leq \mathbf{nH} \leq 255$ )																		
[Default]	$(\mathbf{nL} + \mathbf{nH} \times 256) = 1, \mathbf{nL} = 1, \mathbf{nH} = 0$																		
[Printers not featuring this command]	<b>TM-J2000/J2100</b> , <b>TM-T90</b> , <b>TM-T88IV</b> , <b>TM-T70</b> , <b>TM-P60</b> , <b>TM-U230</b> , <b>TM-U220</b>																		
[Description]	<p>Sets the serial number counter value.</p> <ul style="list-style-type: none"> <li>Specifies the counter value as <math>(\mathbf{nL} + \mathbf{nH} \times 256)</math>.</li> </ul>																		
[Recommended Functions]	<p>This command is supported by some printer models but will not be supported by future models. Future models will not support counter value.</p>																		
[Notes]	<ul style="list-style-type: none"> <li>The serial counter values are stored by <b>GS c</b> in the print buffer.</li> <li>The setting of the counter value set by <b>GS C ;</b> is disabled by processing this command.</li> <li>Settings of this command are effective until <b>GS C ;</b> is executed, <b>ESC @</b> is executed, the printer is reset, or the power is turned off.</li> </ul>																		

### Program Example

```
PRINT #1, CHR$(&H1D); "C1";CHR$(1);CHR$(0);
PRINT #1, CHR$(44);CHR$(1);CHR$(1);CHR$(1);
PRINT #1, CHR$(&H1D); "C2";CHR$(10);CHR$(0);
PRINT #1, CHR$(&H1D); "C0";CHR$(3);CHR$(1);
PRINT #1, "Line";CHR$(&H1D); "c";CHR$(&HA);
PRINT #1, "Line";CHR$(&H1D); "c";CHR$(&HA);
```

### Print Sample

```
Line 010
Line 011
```

## GS C;

[Name] Select counter mode (B)

[Format] ASCII GS C ; **sa** ; **sb** ; **sn** ; **sr** ; **sc** ;  
 Hex 1D 43 3B **sa** 3B **sb** 3B **sn** 3B **sr** 3B **sc** 3B  
 Decimal 29 67 59 **sa** 59 **sb** 59 **sn** 59 **sr** 59 **sc** 59

[Range]  $0 \leq \mathbf{sa} \leq 65535$   
 $0 \leq \mathbf{sb} \leq 65535$   
 $0 \leq \mathbf{sn} \leq 255$   
 $0 \leq \mathbf{sr} \leq 255$   
 $0 \leq \mathbf{sc} \leq 65535$

[Default] **sa** = 1, **sb** = 65535, **sn** = 1, **sr** = 1, **sc** = 1

[Printers not featuring this command] **TM-J2000/J2100**, **TM-T90**, **TM-T88IV**, **TM-T70**, **TM-P60**, **TM-U230**, **TM-U220**

[Description] Sets the serial number counter range, the serial number counter value, the stepping amount, and the repetition number by using character strings.

Count mode	Parameters	Counter range	
		Minimum value	Maximum value
Count-up	<b>sa</b> < <b>sb</b> , <b>sn</b> ≠ "0", and <b>sr</b> ≠ "0"	<b>sa</b>	<b>sb</b>
Count-down	<b>sa</b> > <b>sb</b> , <b>sn</b> ≠ "0", and <b>sr</b> ≠ "0"	<b>sb</b>	<b>sa</b>
Count-stop	<b>sa</b> = <b>sb</b> , <b>sn</b> = "0", or <b>sr</b> = "0"	—	—

- **sa** and **sb** specify the serial number counter ranges (maximum and minimum values).
- **sn** specifies the stepping amount for counting up or down.
- **sr** specifies the repetition number with the counter value fixed.
- **sc** specifies the serial number counter value.

[Recommended Functions]

This command is supported by some printer models and will not be supported by future models. Future models will not support counter value.

[Notes]

- The internal counter value which counts the repetition number of printing by processing this command is "0."
- The value of the counter is updated when executing **GS c** by following the counter mode set by this command.
- In count-up mode, the counter value exceeds the maximum counter value (**sb**), the printer restart counting from the minimum counter value (**sa**).
- In count-down mode, the counter value is below the minimum counter value (**sb**), the printer restart counting from the maximum counter value (**sa**).
- counter value and **sa** is the maximum counter value.
- In count-stop mode, the counter value is not changed by **GS c**.
- The settings of a counter mode set by **GS C 1** and the counter value set by **GS C 2** are disabled by processing this command.
- **sa, sb, sn, sr,** and **sc** specify a value using a decimal character string, respectively.
- **sa, sb, sn, sr,** and **sc** can be omitted (";" which separates an argument, cannot be omitted). Setting value for the omitted argument is not changed.

Example:

When changing only a stepping amount for a count-up or count-down and a counter value, the setting value is [**GS C ; ; ; 5 ; ; 100 ;**].

- The counter value range (maximum value and minimum value), stepping amount of incrementing or decrementing of a counter value, and repetition number of printing are effective until **GS C 1** is executed, **ESC @** is executed, the printer is reset, or the power is turned off.
- The value of the serial number counter set by this command is effective until **GS C 2** is executed, **ESC @** is executed, the printer is reset, or the power is turned off.

## Program Example

```
PRINT #1, CHR$(&H1D);"C";"300;1;1;2;100;";  
PRINT #1, CHR$(&H1D);"C0";CHR$(4);CHR$(1);  
PRINT #1, "No.";CHR$(&H1D);"c";CHR$(&HA);  
PRINT #1, "No.";CHR$(&H1D);"c";CHR$(&HA);  
PRINT #1, "No.";CHR$(&H1D);"c";CHR$(&HA);  
PRINT #1, "No.";CHR$(&H1D);"c";CHR$(&HA);  
PRINT #1, "No.";CHR$(&H1D);"c";CHR$(&HA);
```

## Print Sample

```
No. 0100  
No. 0100  
No. 0099  
No. 0099  
No. 0098
```



## GS c

[Name]	Print counter
[Format]	ASCII      GS c Hex        1D 63 Decimal    29 99
[Range]	None
[Default]	None
[Printers not featuring this command]	<b>TM-J2000/J2100</b> , <b>TM-T90</b> , <b>TM-T88IV</b> , <b>TM-T70</b> , <b>TM-P60</b> , <b>TM-U230</b> , <b>TM-U220</b>
[Description]	Stores the serial number counter value in the print buffer and counts up or down the serial number counter value.
[Recommended Functions]	This command is supported by some printer models and will not be supported by future models. Future models will not support counter value.
[Notes]	<ul style="list-style-type: none"> <li>■ If the counter value is smaller than minimum value or bigger than maximum value when executing this command, counter value is changed based on the count mode set before stored in the print buffer.</li> <li>■ After setting the current counter value in the print buffer as print data (a character string), the printer updates counter value based on the count mode set. <ul style="list-style-type: none"> <li>• In count-up mode, the counter value is updated as [counter value + increase and decrease value].</li> <li>• In count-down mode, the counter value is updated as [counter value – increase and decrease value].</li> <li>• In count-stop mode, the counter value is not updated.</li> </ul> </li> <li>■ The counter value in the print buffer is printed when the printer receives a print command or is in the buffer-full state.</li> <li>■ In count-up mode, if the counter value is the maximum of the specified counter value, it is forced to convert to the minimum value by this command.</li> <li>■ In count-down mode, if the counter value is the minimum of the specified counter value, it is forced to convert to the maximum value by this command.</li> <li>■ The counter print mode is set by <b>GS C 0</b>.</li> </ul>

# CONFIDENTIAL

- The counter mode (count-up, count-down, count-stop) and details of counter (maximum value, minimum value, stepping amount of incrementing or decrementing of a counter value, the repetition number of printing) are set by **GS C 1** or **GS C ;**;
- The counter value is set by **GS C 2** or **GS C ;**;

[Model-dependent variations] None

## Program Example

```
PRINT #1, "AAAAA";CHR$(&H1D);"c";CHR$(&HA);  
PRINT #1, "BBBBB";CHR$(&H1D);"c";CHR$(&HA);
```

## Print Sample

```
AAAAA 1  
BBBBB 2
```

## PRINTING PAPER COMMANDS

**Command**   **Name**

---

**FS ( L**   Select label and black mark control function(s)  
Paper layout setting  
Paper layout information transmission  
Transmit the positioning information  
Feed paper to the label peeling position  
Feed paper to the cutting position  
Feed paper to the print starting position  
Paper layout error special margin setting

## FS ( L

[Name] Select label and black mark control function(s)

[Printers not featuring this command] **TM-J2000/J2100**, **TM-T90**, **TM-T88IV**, **TM-T70**, **TM-U230**, **TM-U220**

[Description] Various processes are performed on label or black mark paper.

- Function code (**fn**) specifies the function.

<b>fn</b>	<b>Function No.</b>	<b>Function name</b>
33	<b>Function 33</b>	Paper layout setting
34	<b>Function 34</b>	Paper layout information transmission
48	<b>Function 48</b>	Transmit the positioning information
65	<b>Function 65</b>	Feed paper to the label peeling position
66	<b>Function 66</b>	Feed paper to the cutting position
67	<b>Function 67</b>	Feed paper to the print starting position
80	<b>Function 80</b>	Paper layout error special margin setting

- **pl**, **ph** specifies (**pl** + **ph** × 256) as the number of bytes after **ph** (**fn** and **[parameters]**). Description of the **[parameters]** is described in each function.

### [Notes]

- The functions of this command are determined by the (**fn**) setting. The actual command operation varies according to function.
- When using label paper (die-cut label), use Functions 65 and 67.
- When using black mark paper, use Functions 66 and 67.
- When origin of layout is set to "paper layout is not used," Functions 65, 66, and 67 do not operate.
- The position information of Function 48 is useful information when the origin of layout is set to "bottom of a label" or "top of a black mark."
- The paper layout (layout reference) is set with <Function 33> of this command or GS ( E <Function 49>.

[Notes for transmission process]

- Data send operations are performed using Function 34 and 48. When you use the functions, obey the following rules.
  - When the host PC transmits the function data, transmit the next data after receiving the corresponding data from the printer.
  - When operating with a serial interface, be sure to configure operation so that the host computer uses the printer only when it is READY.
  - When operating with a parallel interface, the data sent by this function (starting with Header and ending with NUL), as with other data, is first stored in the send buffer, then output in sequential order when the host computer changes to the reverse mode. Note that the send buffer capacity is 99 bytes, and any data exceeding this volume limit will be lost; therefore, when using this command, it is important to configure the operation so that the host computer's change to the reverse mode and the subsequent status send/receive process is performed quickly.
- When communication with the printer uses XON/XOFF control with serial interface, the XOFF code may interrupt the "Header to NUL" data string.
- The information for each function can be identified to other transmission data according to specific data of the transmission data block. When the header transmitted by the printer is [hex = 37H/decimal =55], treat NUL [hex = 00H/decimal =0] as a data group and identify it according to the combination of the header and the identifier.

### Program Example 1 (Two or more labels are printed while peeling off one piece.)

```
GOSUB *Label.Print ← Send a sheet of print data.
PRINT #1, CHR$( &H1C ); " (L"; CHR$( 2 ); CHR( 0 ); CHR$( 65 ); CHR$( 49 ); ← Paper feed to label peeling position <Function 65>
I$=INPUT$( 1 ) ← Waiting for inputting (The key is pushed after the label is peeled off.)
PRINT #1, CHR$( &H1C ); " (L"; CHR$( 2 ); CHR( 0 ); CHR$( 67 ); CHR$( 50 ); ← Putting out the head of the current label <Function 67>
GOSUB *Label.Print ← Send a sheet of print data.
PRINT #1, CHR$( &H1C ); " (L"; CHR$( 2 ); CHR( 0 ); CHR$( 65 ); CHR$( 49 ); ← Paper feed to label peeling position <Function 65>
I$=INPUT$( 1 ) ← Waiting for inputting (The key is pushed after the label is peeled off.)
PRINT #1, CHR$( &H1C ); " (L"; CHR$( 2 ); CHR( 0 ); CHR$( 67 ); CHR$( 50 ); ← Putting out the head of the current label <Function 67>
```

## Program Example 2 (Black mark paper is printed while cutting one piece.)

```
GOSUB *BM.Print ← Send a sheet of print data.
PRINT #1, CHR$( &H1C ); " (L"; CHR$(2); CHR$(0); CHR$(66); CHR$(49); ← Paper feed to cutting position <Function 66>
PRINT #1, CHR$( &H1D ); "V"; CHR$(49); ← Paper cut
PRINT #1, CHR$( &H1C ); " (L"; CHR$(2); CHR$(0); CHR$(67); CHR$(50); ← Feeds Paper to the print start position <Function 67>
GOSUB *BM.Print ← Send a sheet of print data.
PRINT #1, CHR$( &H1C ); " (L"; CHR$(2); CHR$(0); CHR$(66); CHR$(49); ← Paper feed to cutting position <Function 66>
PRINT #1, CHR$( &H1D ); "V"; CHR$(49); ← Paper cut
PRINT #1, CHR$( &H1C ); " (L"; CHR$(2); CHR$(0); CHR$(67); CHR$(50); ← Feeds Paper to the print start position <Function 67>
```

## Program Example 3 (The label is continuously printed.)

```
GOSUB *Label.Print ← Send a sheet of print data.
PRINT #1, CHR$( &H1C ); " (L"; CHR$(2); CHR$(0); CHR$(67); CHR$(49); ← Feeds Paper to the print start position <Function 67>
GOSUB *Label.Print ← Send a sheet of print data.
PRINT #1, CHR$( &H1C ); " (L"; CHR$(2); CHR$(0); CHR$(67); CHR$(49); ← Feeds Paper to the print start position <Function 67>
```

## Program example 4 (sets the paper layout)

```
PRINT #1, CHR$( &h1C ); " (L"; CHR$(22); CHR$(0); CHR$(33); " <Function 33>
PRINT #1, "1"; " Layout reference (sm)
PRINT #1, "700;15;10;0;-10;"; " Vertical layout (sa - se)
PRINT #1, "580;"; " ? Horizontal layout (sf)
```

[Model-dependent variations]

**TM-L90, TM-P60**

# C O N F I D E N T I A L

## **TM-L90**

The paper layout is set with **GS ( E <Function 49>**.

**TM-L90 with Peeler supports Functions 48, 65, and 67. Other printer models support all functions.**

**Specifications other than the above**

**This printer supports <Function 48>, <Function 65>, <Function 66>, and <Function 67>.**

## **TM-P60**

**TM-P60 with Peeler supports all the functions.**

**The paper layout is set with <Function 33> of this command.**

**Specifications other than the above**

**This command is not supported.**

## FS ( L pL pH fn sm [sa] ; [sb] ; [sc] ; [sd] ; [se] ; [sf] ; <Function 33>

[Name] Paper layout setting

[Format] ASCII FS ( L pL pH fn sm [sa] ; [sb] ; [sc] ; [sd] ; [se] ; [sf] ;  
 Hex 1C 28 4C pL pH 21 sm [sa] 3B [sb] 3B [sc] 3B [sd] 3B [se] 3B [sf] 3B  
 Decimal 28 40 76 pL pH 33 sm [sa] 59 [sb] 59 [sc] 59 [sd] 59 [se] 59 [sf] 59

[Range] **TM-P60:**  $8 = (pL + pH \times 256) \leq 26$  ( $8 \leq pL \leq 26, pH = 0$ )  
**fn = 33**  
**"0" ≤ sm ≤ "3"**  
**Other parameters differ according to sm.**

Parameter	When (sm = "0") is specified	When (sm = "1") is specified	When (sm = "2") is specified	When (sm = "3") is specified
<b>sa</b>	"0"	"0," "284" - "1550"	"0," "284" - "1550"	"0," "284" - "1550"
<b>sb</b>	"0"	"0" - "1500"	"-15" - "1500"	"-150" - "1500"
<b>sc</b>	"0"	"0" - "50"	"0" - "50"	"-290" - "50"
<b>sd</b>	"0"	"0"	"0" - "15"	"0"
<b>se</b>	"0"	"-15" - "0"	"-15" - "15"	"0"
<b>sf</b>	"290" - "600"	"290" - "600"	"290" - "600"	"290" - "600"

- The value may be invalid in combination with the parameter. For details, refer to [Description].

[Default] **sm = "1," sa = "0," sb = "15," sc = "15," sd = "0," se = "-15," sf = "580"**



# CONFIDENTIAL

[Description]

Sets the paper layout (layout reference, vertical layout, horizontal layout).

■ Sets "Layout reference (print reference/eject reference)" with **sm**.

<b>sm</b>	<b>Layout reference</b>	<b>Relevant paper</b>
"0"	No reference (do not use layout)	Receipt (no black mark)
"1"	Print reference: Label top edge Eject reference: Label bottom edge	Die cut label paper (no black mark)
"2"	Print reference: Black mark bottom edge Eject reference: Black mark top edge	Die cut label paper (black mark)
"3"	Print reference: Black mark top edge Eject reference: Black mark top edge	Receipt (black mark)

■ Sets "Vertical layout" with **sa - se**.

	<b>Vertical layout</b>
<b>sa</b>	( <b>sa</b> = "0"): Does not specify the distance from the print reference to the next print reference ( <b>sa</b> ≠ "0"): Sets distance from the print reference to the next print reference
<b>sb</b>	The distance from the print reference to the print start position
<b>sc</b>	The distance from the eject reference to the cutting position
<b>sd</b>	The distance from the eject reference to the label bottom edge position
<b>se</b>	The distance from the eject reference to the bottom edge of the printing area

- The setting unit is 0.1 mm.

- Sets “Horizontal layout” with **sf**.

	<b>Horizontal layout</b>
<b>sf</b>	Paper width

- The setting unit is 0.1 mm.

[Notes]

- Use this function at the start of the line when the standard mode is selected.

# CONFIDENTIAL

- The relationship between the setting values and paper layout of the vertical layout and horizontal layout is shown in the diagram below. A positive number specifies the paper feed direction (downward in the diagram), while a negative number specifies the reverse of the feed direction (upward in the diagram).

- When using die cut labels (**sm** = "1" or "2")

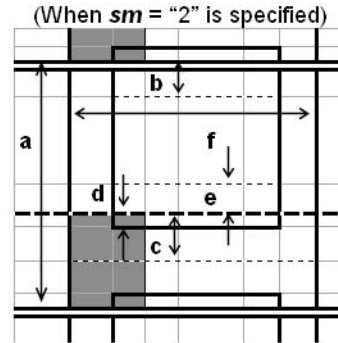
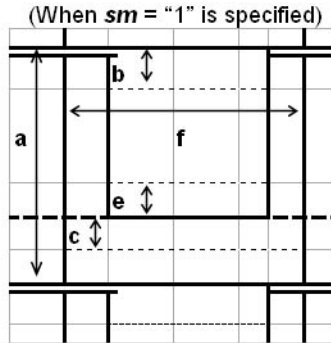

Double line:	Print reference
Thick dotted line:	Eject reference
Thin dotted line:	Top edge/bottom edge of printing area or cutting position
Continuous line:	Paper (label paper)
*Parameters with a fixed value for the domain are not shown	

- When using receipts (black mark) (**sm** = "3")

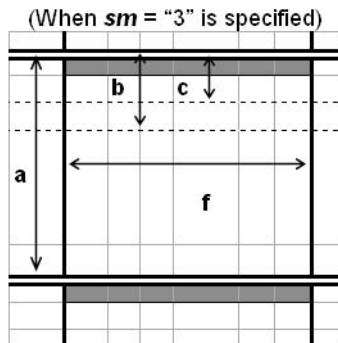

Double line:	Print reference and eject reference
Continuous line:	Paper (label paper)
Dotted line:	Print starting position or cutting position
*Parameters with a fixed value for the domain are not shown	

- When (**sm** = "1") or (**sm** = "2") is specified, note the following points when setting the printing area and cutting position.
  - Specify that the printing area fits within with the label paper (do not specify any part of the printing area on the backing paper).
  - Specify that the cutting position is on the backing paper (do not specify the cutting position on the label paper).
- The setting values of (**sa - sf**) expressed as decimals are converted to text data and the high-order values are specified first. When specifying a negative number, add "-" at the beginning.  
Example: When specifying 120, the data is the 3 bytes "120" [Hexadecimal = 31H, 32H, 30H / Decimal = 49, 50, 48].  
When specifying -10, the data is the 3 bytes "-10" [Hexadecimal = 2DH, 31H, 30H / Decimal = 45, 49, 48].
- If the currently set "Layout reference" and (**sm**) are the same value, (**sa - sf**) can be omitted. Omitted settings are not changed. However, when omitting parameters ";" cannot be omitted.  
Example: (When omitting **sc** and **se**) **FS ( L pL pH fn sm sa ; sb ; ; sd ; ; sf ;**
- Calculates the effective value used for actual print operation based on the setting values of this function, the setting value for paper width, and the limiting values for mechanical configuration (mechanical pitch, print head position, etc.) The setting value and effective value can be acquired with <Function 34> of this command.
- When changing to paper with a different layout, reset the paper layout with this function.
- The paper layout setting is enabled until the following operations are executed. It is not initialized by **ESC @**. The setting value for this function is the saved data of **GS ( M <Function 1>**.
  - Executing this function
  - Turning off the power or resetting

- The setting values of this function affect the following operations and values.

Setting value	Affected operation or value
<b>sa</b>	Paper layout error detection
<b>sb</b>	Label paper/black mark paper feed to the print start position
<b>sc</b>	Label paper/black mark paper feed to the cutting starting
<b>sd</b>	Label paper/black mark paper feed to the peeling position
<b>se</b>	Skipping backing paper when printing die cut label paper
<b>sf</b>	Standard mode/page mode printable area

- Even if the setting value for paper width (**sf**) is changed with this function, the **ESC W** and **GS W** setting values do not change. After changing (**sf**) of this function, set **ESC W** and **GS W**, or initialize the setting values of **ESC W** and **GS W** with **ESC @**. However, if you use **ESC @**, the setting values of the various commands are also initialized.
- When settings other than "No reference" are specified for layout reference (**sm** ≠ "0"), a paper layout error may occur with a vertical layout (**sa**). For details of the paper layout error, refer to the model information.

# CONFIDENTIAL

[Model-dependent variations] **TM-L90**, **TM-P60**

## **TM-L90**

**This printer does not support this function.**

## **TM-P60**

Since combinations with the parameters in the table below result in invalid values, this function will not work.

<b>sm</b>	<b>Combinations resulting in invalid values</b>
<b>"1"</b>	<b>If (<math>sa \leq sb + sc +  se </math>) when (<math>sa \neq "0"</math>)</b>
<b>"2"</b>	<b>If (<math>sa \leq  sb  + sc +  se </math>) when (<math>sa \neq "0"</math>) and (<math>se &lt; "0"</math>)</b> <b>If (<math>sa \leq  sb  + sc</math>) when (<math>sa \neq "0"</math>) and (<math>"0" \leq se</math>)</b> <b>If (<math>sc &lt; sd</math>)</b> <b>If (<math>sd &lt; se</math>) when (<math>"0" \leq se</math>)</b>
<b>"3"</b>	<b>If (<math>sa \leq  sc </math>) when (<math>sa \neq "0"</math>) and (<math>sb &lt; "0"</math>) and (<math>sc &lt; "0"</math>)</b> <b>If (<math>sa \leq sb +  sc </math>) when (<math>sa \neq "0"</math>) and (<math>"0" \leq sb</math>) and (<math>sc &lt; "0"</math>)</b> <b>If (<math>sa \leq sb</math>) when (<math>sa \neq "0"</math>) and (<math>"0" \leq sb</math>) and (<math>"0" \leq sc</math>)</b> <b>If (<math>sb &lt; "0"</math>) and (<math>"0" \leq sc</math>)</b> <b>If (<math> sc  \leq  sb  + 20</math>) when (<math>sb &lt; "0"</math>) and (<math>sc &lt; "0"</math>)</b> <b>If (<math> sb  +  sc  \leq 20</math>) when (<math>"0" \leq sb</math>) and (<math>sc &lt; "0"</math>)</b> <b>If (<math>sb &lt; sc + 20</math>) when (<math>"0" \leq sb</math>) and (<math>"0" \leq sc</math>)</b>

\* In the table, "**|sb|**" indicates the absolute value of **sb**.

When using die cut labels (when layout reference (**sm** = "1," "2") is specified), note the caution below when setting the paper layout.

- Set the cutting position (**sc**) between labels and as far from the top and bottom edges of the labels as possible.

- Sets a value in excess of 2.0 mm for the distance from the cutting position to the next print starting position. If it is set to less than 2.0 mm, the paper feed operation may not be executed normally.

When "Layout reference (sm = "1," "2," "3")" and "vertical layout (sa = "0")" are specified, even if paper feed of about 155 mm is executed, if the print reference cannot be found, a paper error occurs. This is caused by using paper that is outside the specifications. Loading paper that meets the product specifications recovers from the error.

When "Layout reference (sm = "1," "2," "3")" and "vertical layout (sa ≠ "0")" are specified, if any of the following situations are detected, a paper layout error occurs. This is because the paper used and the "vertical layout (sa)" setting value set with this function are different. After loading the correct paper, **DLE ENQ (n = 2)** recovers from the error.

- (a) When the next print reference is detected when paper feed that does not fulfill (sa setting value - 1.25 mm) after the print reference is passed.
  - (b) When the next eject reference is detected when paper feed that does not fulfill (sa setting value - 1.25 mm) after the eject reference is passed.
  - (c) When the next print reference is not found even when paper feed that fulfills (sa setting value + 1.25 mm) after the print reference is passed.
  - (d) When the next eject reference is not found even when paper feed that fulfills (sa setting value + 1.25 mm) after the eject reference is passed.
  - (e) With mechanical initialization when memory switch [Msw8-6] is on, in any of the following cases
    - When the next print reference is detected when paper feed that does not fulfill (sa setting value - 1.25 mm - special machine value (setting value of <Function 80> of this command)) is being executed after mechanical initialization.
    - When the next print reference is not found even when paper feed that fulfills (sa setting value + 1.25 mm + special machine value (setting value of <Function 80> of this command)) is executed after mechanical initialization.
- Irrespective of whether the correct paper is used, if a paper layout error occurs when printing the first sheet after mechanical initialization (when the peeler cover is closed, when the power is turned on, or the printer is reset), the paper may not be set in the correct position. When it is difficult to position the paper, it is possible to avoid paper layout errors by changing the setting value of <Function 80>. Refer to <Function 80> of this command for details of this command.

# CONFIDENTIAL

The horizontal size of the printable area, specified with horizontal layout (**sf**) and layout reference (**sm**) is as shown in the table below.

You can also specify transmission of the effective value and acquire the dot count of the printable area with <Function 34> of this command.

(sf) setting value	Horizontal size of the printable area	
	When (sm = "0," "3") is specified	When (sm = "1," "2") is specified
"600" to "590"	54.0 mm (432 dots)	50.0 mm (400 dots)
"589" to "585"	53.0 mm (424 dots)	49.0 mm (392 dots)
"584" to "575"	52.5 mm (420 dots)	48.5 mm (388 dots)
"574" to "290"	$(\text{int}(\text{sf} \div 10) - 5)$ mm $(\text{int}(\text{sf} \div 10) - 5) \times 8$ dots	$(\text{int}(\text{sf} \div 10) - 9)$ mm $(\text{int}(\text{sf} \div 10) - 9) \times 8$ dots

- The left edge of the printing area when the layout reference is specified (sm = "1," "2"), is the position of the 17th dot when (sm = "0," "3") is specified.

The operation of the commands shown below differ according to the layout reference (sm) specified

Command	sm = "0"	sm = "1"	sm = "2"	sm = "3"
<b>FS ( L</b> <Function 65>	No	Yes	Yes	No
<b>FS ( L</b> <Function 66>	No	Yes	Yes	Yes
<b>FS ( L</b> <Function 67>	No	Yes	Yes	Yes
<b>GS V</b> <Function B>	Yes	No	No	No

[Yes: Operates / No: Does not operate]



## FS ( L *pL pH fn n* <Function 34>

[Name] Paper layout information transmission

[Format] ASCII FS ( L **pL pH fn n**  
 Hex 1C 28 4C 02 00 22 **n**  
 Decimal 28 40 76 2 0 34 **n**

[Range] (**pL** + **pH** × 256) = 2 (**pL** = 2, **pH** = 0)  
**fn** = 34  
**n** = 64,80

[Description] Transmits paper layout information specified by **n**.

<b>n</b>	Paper layout information type
64	Paper layout setting value (unit: 0.1 mm)
80	Paper layout effective value (unit: dots)

[Notes] ■ With this function, the [Header - NUL] shown below is transmitted.

Transmission data	Hex	Decimal	Amount of data
Header	37H	55	1 byte
Identifier	4BH	76	1 byte
Information type (*1)	30H - 39H	48 - 57	2 bytes
Separator	1FH	31	1 byte
Layout information (*2)			
Layout reference ( <b>sm</b> )	30H - 33H	48 - 51	0 or 1 byte
Separator	1FH	31	1 byte
Vertical layout ( <b>sa</b> )	30H - 39H	48 - 57	0 - 5 bytes
Separator	1FH	31	1 byte

Vertical layout ( <b>sb</b> )	2DH, 30H - 39H	45,48 - 57	0 - 5 bytes
Separator	1FH	31	1 byte
Vertical layout ( <b>sc</b> )	2DH, 30H - 39H	45,48 - 57	0 - 5 bytes
Separator	1FH	31	1 byte
Vertical layout ( <b>sd</b> )	30H - 39H	48 - 57	0 - 5 bytes
Separator	1FH	31	1 byte
Vertical layout ( <b>se</b> )	2DH, 30H - 39H	45,48 - 57	0 - 5 bytes
Separator	1FH	31	1 byte
Horizontal layout ( <b>sf</b> )	30H - 39H	48 - 57	0 - 5 bytes
NUL	00H	0	1 byte

(\*1) [Information type] is the parameter of this function (**n**) expressed as a decimal, converted to text data and sent from high-order bytes first.

Example: When (**n** = 64) is the setting value for [Information type], the data is the 2 bytes "64"  
[Hexadecimal = 36H, 34H / Decimal = 54, 52].

When (**n** = 80) is the effective value for [Information type], the data is the 2 bytes "80"  
[Hexadecimal = 36H, 30H / Decimal = 56, 48].

(\*2) (**sm - sf**) of [Layout information] corresponds to (**sm - sf**) of <Function 33> of this command. Each item of information expressed as decimals is converted to text data and the high-order values are transmitted first.

Example: When [Vertical layout (**sb**) is 15, the data is the 2 bytes "15" [Hexadecimal = 31H, 35H / Decimal = 49,53].

- The transmission data when a setting value (**n** = 64) is specified for information type is as follows.
  - The setting value indicates the paper layout information (the setting value of <Function 33> of this command) saved in memory.
  - When the first item of data of each layout information is "-" [Hexadecimal = 2DH / Decimal = 45], it indicates a negative number.

- The transmission data when an effective value (**n** = 80) is specified for information type is as follows.
  - The effective value indicates the value, calculated based on the following values, that is actually used for the operation. The unit is 1 dot.
    - The paper layout information (the setting value of <Function 33> of this command) saved in memory
    - The specified value for the mechanical configuration (minimum pitch etc.)
  - The effective value for horizontal layout (**sf**) is indicated by the horizontal size of the printable area, calculated from the horizontal layout (**sf**) and layout reference (**sm**) set.
- For a description of transmission of the data group, refer to [Description: Applied to transmission of the data group].

[Model-dependent variations] **TM-L90**

## **TM-L90**

**TM-L90 with Peeler does not support this function.**

## FS ( L <Function 48 >

---

- [Name] Transmit the positioning information
- [Format] ASCII FS ( L **pL** **pH** **fn** **m**  
 Hex 1C 28 4C 02 00 30 **m**  
 Decimal 28 40 76 2 0 48 **m**
- [Range] (**pL** + **pH** × 256) = 2 (**pL** = 2, **pH** = 0)  
**m** = 48  
**fn** = 80
- [Description] Transmits the positioning information for the label or black mark paper.
- [Notes] ■ Header to NUL shown in the following is transmitted in this function.

Transmission data	Hex	Decimal	Number of data
Header	37H	55	1 byte
Identifier	38H	56	1 byte
Position information A	40H to 7FH	64 to 127	1 byte
Position information B	40H to 7FH	64 to 127	1 byte
NUL	00H	0	1 byte

■ [Position information A] is shown in the following.

Bit	Function	Binary	Hex	Decimal
0	Relation to the label peeling position; Not at label peeling position.	0	00	0
	Relation to the label peeling position: Standby at the label peeling position.	1	01	1
1	Relation to the cutting position: Not at cutting position.	0	00	0
	Relation to the cutting position: Standby at the cutting position.	0	02	2
2	Relation to the print start position: Not at print start position.	0	00	0
	Relation to the print start position: Standby at the print start position.	1	04	4
3 to 5	Reserved	-	-	-
6	Fixed	1	40	64
7	Fixed	0	00	0

- Bit 0 becomes "1" immediately after this command < Function 65> is executed, and becomes "0" by executing mechanical operations with paper feed.
- Bit 1 becomes "1" immediately after this command < Function 66> is executed, and becomes "0" by executing mechanical operations with paper feed.
- Bit 2 becomes "1" when cover closes, manual feeding by pressing the switch is done, the print start according to print instruction, and the power supply is turned on immediately after this command < Function 67> is executed, and becomes "0" by executing mechanical operations with paper feed.
- Bits 0, 1, and 2 always become "0" when the origin of layout is "paper layout is not used" and when the cover is open.

■ [Position information B] is shown in the following.

Bit	Function	Binary	Hex	Decimal
0	The print start of the current label can operate.	0	00	0
	The print start operation of the current label is impossible.	1	01	1
1	The print start of the next label can operate.	0	00	0
	The print start of the next label is impossible.	1	02	2
2 to 5	(Reserved)	-	-	-
6	Fixed	1	40	64
7	Fixed	0	00	0

- Bits 0 and 1 always become “1” when the paper layout is “Receipt (without black mark)” and when the cover is open.
- “Present label” is a print area of the label paper or the black mark paper which corresponds to either of the following:
  - a) “Print area where print start position exists right under label peeling position” right after executing <Function 65>.
  - b) “Print area where print start position exists right under cutting position” right after executing <Function 66>.
  - c) “Print area at print start position” right after executing <Function 67> and the print start operation.
  - d) Print area with print position, except for the above-mentioned.
- “The next label” is “print area of the following label paper or the black mark paper of the present label. ”

■ See previous [Notes for transmission process] for description of transmission process.

[Model-dependent variations]

**TM-L90, TM-P60**

## TM-L90

When it meets either of the following requirements, bit 0 of [Position Information B] becomes "The print start operation of the label is possible now." Set the paper layout (**sb**, **sd**, **se**) using Function 49 of **GS ( E**.

(1) When position information A is "Standby at the label peeling position" (soon after executing this command **fn = 65**) and when it meets either of the following requirements:

- If (**se** ≤ **sd**), 24 mm {0.94 inch} ≤ (**sb** - **se**) and 3.6 mm {0.14 inch} ≤ (**sd** - **se**)
- If (**sd** < **se**), 24 mm {0.94 inch} ≤ (**sb** × 2 - **se**) and 3.6 mm {0.14 inch} ≤ (**sb** + **sd** - **se**)

(2) When position information A is "Standby at the cutting position" (soon after executing this command **fn = 66**) and when it meets either of the following requirements:

- If (**se** ≤ **sd**), 14 mm {0.55 inch} ≤ (**sb** - **se**) and 3.6 mm {0.14 inch} ≤ (**sd** - **se**)
- If (**sd** < **se**), 14 mm {0.55 inch} ≤ (**sb** × 2 - **se**) and 3.6 mm {0.14 inch} ≤ (**sb** + **sd** - **se**)

When it meets either of the following requirements, bit 1 of [Position information B] becomes "The print start operation of the next label is possible."

(1) When position information A is "Standby at the label peeling position" (soon after executing this command **fn = 65**) and when it meets either of the following requirements:

- If (**se** ≤ **sd**), 24 mm {0.94 inch} ≤ (**sb** × 2 - **se**) and 3.6 mm {0.14 inch} ≤ (**sb** + **sd** - **se**)
- If (**sd** < **se**), 24 mm {0.94 inch} ≤ (**sb** × 3 - **se**) and 3.6 mm {0.14 inch} ≤ (**sb** × 2 + **sd** - **se**)

(2) When position information A is "Standby at the cutting position" (soon after executing this command **fn = 66**) and when it meets either of the following requirements:

- If (**se** ≤ **sd**), 14 mm {0.55 inch} ≤ (**sb** × 2 - **se**) and 3.6 mm {0.14 inch} ≤ (**sb** + **sd** - **se**)
- If (**sd** < **se**), 14 mm {0.55 inch} ≤ (**sb** × 3 - **se**) and 3.6 mm {0.14 inch} ≤ (**sb** × 2 + **sd** - **se**)

## TM-P60

[Peeler model]

If the current label feed to the print starting position operation fulfills any of the following conditions, Bit 0 of [Position information B] becomes "Feed current label to the print starting position is possible."

1. When Position information A is "standby in peeling position" (immediately after executing <Function 65> of this command)
2. When Position information A is "standby in cutting position" (immediately after executing <Function 66> of this command)

At the next operation to feed labels to the print starting position, Bit 1 of [Position information B] becomes "Feed next label to the print starting position is possible" irrespective of the current position.



## FS ( L <Function 65 >

---

[Name] Feed paper to the label peeling position

[Format] ASCII FS ( L **pL** **pH** **fn** **m**  
 Hex 1C 28 4C 02 00 41 **m**  
 Decimal 28 40 76 2 0 65 **m**

[Range] (**pL** + **pH** × 256) = 2 (**pL** = 2, **pH** = 0)  
**m** = 48, 49  
**fn** = 65

**TM-L90: with Peeler**

**m = 48 [When the peeling issuing mode is selected]**

**m = 48, 49 [When the continuous issuing mode is selected]**

**[Models other than the above]**

**m = 48, 49**

**TM-P60: m = 48, 49**

[Description] Feeds paper to the label peeling position.

<b>m</b>	<b>Function</b>
48	Feeds paper to the label peeling position. However, if the paper is in standby at the label peeling position, the printer does not feed.
49	Feeds paper to the label peeling position. However, if the paper is in standby at the label peeling position, the printer feeds paper to the next label peeling position.

- [Notes]
- Please use this function by using “the first state of the line” in standard mode.
  - This function is used only with label paper.
  - The paper feed operation ends when no paper is detected in the paper feed to the label peeling position.
  - [Position information A] transmitted by Function 48 becomes (bit 0 = 1) when this function is processed. Moreover, the print area of the label paper or black mark paper if there is a print start position right under the label peeling position becomes “current label.”
  - “Label peeling position” is the position where the label can be peeled off by hand. Details are different depending on the model.

- Models with the peeling function will be in the label removal waiting status when Function 65 is executed. This status continues during label removal and printer reset or label removal and power off. The label removal waiting status can be checked by **DLE EOT** (**n** = 8, **a** = 3: Peeler status).

[Model-dependent variations]

**TM-L90**, **TM-P60**

## TM-L90

The following operation is executed according to a set value of the paper layout.

Set value of paper layout	Operation
Paper layout ( <b>sb-se</b> ) is less than 24 mm {0.94 inch} or Paper layout ( <b>sb-se</b> ) is more than or 29 mm {1.1 inches}	Execute the paper feed to the manual cutter position by "Cutting position" ( <b>se</b> ) specified by the paper layout.
Paper layout ( <b>b-e</b> ) is between 24 mm {0.94 inch} and 29 mm {1.1 inches}	Execute the paper feed by the amount which corresponds to paper layout ( <b>sb-se</b> ).

\*Set the paper layout (**sb**, **se**) by the Function 49 of **GS** ( **E**).

### TM-L90 with Peeler:

When the peeling issuing mode is selected, the status changes to label removal standby when this function is executed. You can check the label removal standby status with **DLE EOT** (**n** = 8, **a** = 3: Peeler status) or the basic **ASB** status. When the label removal is checked by pressing the **FEED** button, the printer is in the waiting status for the **FEED** button to be pressed. The waiting status for the **FEED** button to be pressed can be checked by the basic **ASB** status or **DLE EOT** (**n** = 1: Printer status) "Online recovery waiting status."

Switching between the peeling issuing mode and the continuous issuing mode can be done with a slide switch on the printer. This switch can be used when the roll paper cover is open.

## TM-P60

This function operates when (**sm** = "1", "2") is specified for the layout reference.

With the operation of this function, paper feed is executed until the paper layout "eject reference" reaches the mechanical peeling position.

When the peeling issuing mode is selected, the status changes to label removal standby when this function is executed. You can check the label removal standby status with DLE EOT ( $n = 8, a = 3$ : Peeler status) or the basic ASB status.

The peeling issuing mode/continuous issuing mode is selected with the operation shown below.

## Selecting the peeling issuing mode

Step	Operation
1	Press the cover open button, and open the peeler cover.
2	If the paper roll cover was open in Step 1, close the paper roll cover.
3	Press the peeler changeover lever. The peeler holder is raised.
4	Close the peeler cover.

## Selecting the continuous issuing mode

Step	Operation
1	Press the cover open button, and open the peeler cover.
2	If the paper roll cover was open in Step 1, close the paper roll cover.
3	Fold up the peeler holder.
4	Close the peeler cover.

## FS ( L <Function 66 >

---

[Name] Feed paper to the cutting position

[Format] ASCII FS ( L **pL** **pH** **fn** **m**  
 Hex 1C 28 4C 02 00 42 **m**  
 Decimal 28 40 76 2 0 66 **m**

[Range] (**pL** + **pH** × 256) = 2 (**pL** = 2, **pH** = 0)  
**m** = 48, 49  
**fn** = 66

[Description] Feeds paper to the cutting position.

<b>m</b>	<b>Function</b>
48	Feeds paper to the cutting position. However, if the paper is in standby at the cutting position, the printer does not feed.
49	Feeds paper to the cutting position. However, if the paper is in standby at the cutting position, the printer feeds paper to the next cutting position.

- [Notes]
- Please use this function by using “the first state of the line” in standard mode.
  - This function is used when using “black mark paper.”
  - The paper feed operation ends when no paper is detected in the paper feed to the cutting position.
  - [Position information A] transmitted by Function 48 becomes (bit 1 = 1) when this function is used. Moreover, the print area of the label paper or black mark paper if there is a print start position right under the cutting position becomes “current label.”

[Model-dependent variations] **TM-L90, TM-P60**

### TM-L90

**TM-L90 with Peeler does not support this function.**

## TM-P60

This function operates when (**sm** = "1", "2", "3") is specified for the layout reference.

With the operation of this function, paper feed is executed until the paper layout "eject reference" reaches the mechanical manual cut position.

## FS ( L <Function 67 >

---

[Name] Feed paper to the print starting position

[Format] ASCII FS ( L **pL** **pH** **fn** **m**  
 Hex 1C 28 4C 02 00 43 **m**  
 Decimal 28 40 76 2 0 67 **m**

[Range]  $(pL + pH \times 256) = 2$  (**pL** = 2, **pH** = 0)  
**m** = 48, 49, 50  
**fn** = 67

**TM-L90: [with Peeler]**

**m = 50 [When the peeling issuing mode is selected]**

**48 ≤ m ≤ 50 [When the continuous issuing mode is selected]**

**[Models other than the above]**

**48 ≤ m ≤ 50**

**TM-P60: 48 ≤ m ≤ 50**

[Range] Executes paper feed until the “print starting position” specified in the paper layout reaches the print head position.

<b>m</b>	<b>Function</b>
48	Feeds paper to the print starting position on the next label. However, if the paper is in standby at the print starting position, the printer does not feed.
49	Feeds paper to the print starting position on the next label. However, if the paper is in standby at the print starting position, the printer feeds paper to the next print starting position.
50	Feeds paper to the label peeling position. However, if the paper is in standby at the label peeling position, the printer feeds paper to the next label peeling position. Feeds paper to the print starting position on the current label. However, if the paper is in standby at the print starting position, the printer does not feed.

[Notes] ■ Use this function by using “the first state of the line” in standard mode.

- This function is used when using label paper or black mark paper.
- The paper feed operation is ended when no paper is detected in the paper feed to the print start position.
- [Position information A] transmitted by Function 48 becomes (bit 2 = 1) when this function is processed. Moreover, the print area of the label paper or black mark paper that the print position includes the print start position becomes "current label," and the following label of the current label becomes "next label."

[Model-dependent variations]

**TM-L90, TM-P60**

## **TM-L90**

**When the positioning information B of FS ( L <Function 48> is [Bit 0 = 1: Impossible to feed paper to the print starting position on the next label], the operation of (m = 50) is as follows:**

**When the peeling issuing mode is selected, the printer does not feed.**

**When the continuous issuing mode is selected, the printer feeds paper to the print starting position on the next label.**

**Switching between the peeling issuing mode and the continuous issuing mode can be done with a slide switch on the printer. This switch can be used when the roll paper cover is open.**

## **TM-P60**

**[Peeler model]**

**This function operates when (sm = "1", "2", "3") is specified for the layout reference.**

**This function does not operate when the position information of <Function 48> of this command is "Feed current label to the print starting position is not possible."**

## FS ( L *pL pH fn sn* <Function 80>

---

[Name] Paper layout error special margin setting

[Format]

ASCII	FS (	L	<b>pL</b>	<b>pH</b>	<b>fn</b>	<b>sn</b>
Hex	1C 28	4C	<b>pL</b>	<b>pH</b>	50	<b>sn</b>
Decimal	28 40	76	<b>pL</b>	<b>pH</b>	80	<b>sn</b>

[Range] (**pL** + **pH** × 256) = 2,3 (**pL** = 2, 3, **pH** = 0)

**fn** = 80

**TM-P60: "0" ≤ sn ≤ "50"**

[Default] **sn** = "0"

[Description] Sets the paper layout error special margin.

- Sets the special margin for the vertical layout (**sa**) of <Function 33> of this command to [± (**sn** × 0.1 mm)]. The setting unit is 0.1 mm.

[Notes] ■ The setting values of (**sn**) expressed as decimals are converted to text data and the high-order values are specified first.

Example: When specifying 10, the data is the 2 bytes "10" [Hexadecimal = 31H, 30H / Decimal = 49, 48].

■ A paper layout error may occur with (**sn**) of this function and with the paper layout (vertical layout (**sa**)) with the print reference detection when the first page is printed when the paper is replaced or after turning on the power, when a setting other than "No reference" (**sm** ≠ "0") is specified for paper layout (layout reference) for <Function 33> of this command. For details of the paper layout error, refer to the model information.

■ The setting value of this function is enabled until the following operations are executed. It is not initialized by **ESC @**. The setting value for this function is the saved data of **GS ( M** <Function 1>.

- Executing this function
- Turning off the power or resetting

■ The setting value of this function is affected by detection of the print reference when the first sheet is printed at the time of the operations below.

- When closing the cover



- When turning off the power or resetting

[Model-dependent variations] **TM-L90**, **TM-P60**

## **TM-L90**

**TM-L90 with Peeler does not support this function.**

## **TM-P60**

Refer to the [Model information] of <Function 33> of this command for details of the paper layout error.

If a paper layout error occurs when printing the first sheet when the peeler cover is closed, when the power is turned on, or the printer is reset, the paper may not be set in the correct position.

When it is difficult to position the paper, it is possible to avoid paper layout errors by setting a high value for this function. However, if you set a high value for this function, the changed alignment of the printing position of the first sheet may adversely affect the printing of subsequent sheets.

## CHARACTER CODE TABLES

SP in a table represents space. See [Using the character code tables](#) for information on how to read these tables.

Page 0 (PC437: U.S.A., Standard Europe) (International character set: U.S.A.)

HEX	HEX	0	1	2	3	4	5	6	7	8	9	A	B	C	D	E	F
HEX	BIN	0000	0001	0010	0011	0100	0101	0110	0111	1000	1001	1010	1011	1100	1101	1110	1111
0	0000	NUL	DLE	SP	0	@	P		p	Ç	É	á	⌘	⌘	⌘	α	≡
		00	16	32	48	64	80	96	112	128	144	160	176	192	208	224	240
1	0001		!	1	A	Q	a	q	ü	æ	í	⌘	⌘	⌘	β	±	
		01	17	33	49	65	81	97	113	129	145	161	177	193	209	225	241
2	0010		"	2	B	R	b	r	é	Æ	ó	⌘	⌘	⌘	Γ	≥	
		02	18	34	50	66	82	98	114	130	146	162	178	194	210	226	242
3	0011		#	3	C	S	c	s	â	ô	ú		⌘	⌘	⌘	π	≤
		03	19	35	51	67	83	99	115	131	147	163	179	195	211	227	243
4	0100	EOT		\$	4	D	T	d	t	ä	ö	ñ	⌘	⌘	⌘	Σ	ƒ
		04	20	36	52	68	84	100	116	132	148	164	180	196	212	228	244
5	0101	ENQ		%	5	E	U	e	u	à	ò	Ñ	⌘	⌘	⌘	σ	J
		05	21	37	53	69	85	101	117	133	149	165	181	197	213	229	245
6	0110		&	6	F	V	f	v	á	û	á	⌘	⌘	⌘	⌘	μ	÷
		06	22	38	54	70	86	102	118	134	150	166	182	198	214	230	246
7	0111		'	7	G	W	g	w	ç	ù	ó	⌘	⌘	⌘	⌘	τ	≈
		07	23	39	55	71	87	103	119	135	151	167	183	199	215	231	247
8	1000	BS	CAN	(	8	H	X	h	x	ê	ÿ	ç	⌘	⌘	⌘	φ	°
		08	24	40	56	72	88	104	120	136	152	168	184	200	216	232	248
9	1001	HT		)	9	I	Y	i	y	ë	ö	⌘	⌘	⌘	⌘	θ	•
		09	25	41	57	73	89	105	121	137	153	169	185	201	217	233	249
A	1010	LF		*	:	J	Z	j	z	è	ù	⌘	⌘	⌘	⌘	Ω	·
		10	26	42	58	74	90	106	122	138	154	170	186	202	218	234	250
B	1011		ESC	+	;	K	[	k	{	ï	φ	½	⌘	⌘	⌘	δ	√
		11	27	43	59	75	91	107	123	139	155	171	187	203	219	235	251
C	1100	FF	FS	,	<	L	\	l	ı	î	£	¼	⌘	⌘	⌘	∞	∞
		12	28	44	60	76	92	108	124	140	156	172	188	204	220	236	252
D	1101	CR	GS	-	=	M	]	m	}	ì	¥	ı	⌘	⌘	⌘	∅	²
		13	29	45	61	77	93	109	125	141	157	173	189	205	221	237	253
E	1110		.	>	>	N	~	n	~	Ä	Pt	«	⌘	⌘	⌘	ε	■
		14	30	46	62	78	94	110	126	142	158	174	190	206	222	238	254
F	1111		/	?	?	O	—	o	SP	À	f	»	⌘	⌘	⌘	∩	SP
		15	31	47	63	79	95	111	127	143	159	175	191	207	223	239	255

# CONFIDENTIAL

Page 1 (Katakana)

	HEX	8	9	A	B	C	D	E	F
HEX	BIN	1000	1001	1010	1011	1100	1101	1110	1111
0	0000	ー 128	丄 144	SP 160	ー 176	夕 192	ミ 208	ニ 224	× 240
1	0001	ー 129	┘ 145	。 161	ア 177	チ 193	ム 209	フ 225	円 241
2	0010	■ 130	┘ 146	「 162	イ 178	ツ 194	メ 210	キ 226	年 242
3	0011	■ 131	┘ 147	」 163	ウ 179	テ 195	モ 211	コ 227	月 243
4	0100	■ 132	ー 148	、 164	エ 180	ト 196	ヤ 212	▲ 228	日 244
5	0101	■ 133	ー 149	・ 165	オ 181	ナ 197	ユ 213	▲ 229	時 245
6	0110	■ 134	┘ 150	ヲ 166	カ 182	ニ 198	ヨ 214	▼ 230	分 246
7	0111	■ 135	┘ 151	ア 167	キ 183	ヌ 199	ラ 215	▼ 231	秒 247
8	1000	┘ 136	┘ 152	イ 168	ク 184	ネ 200	リ 216	♠ 232	千 248
9	1001	┘ 137	┘ 153	ウ 169	ケ 185	ノ 201	ル 217	♥ 233	市 249
A	1010	┘ 138	┘ 154	エ 170	コ 186	ハ 202	レ 218	♦ 234	区 250
B	1011	■ 139	┘ 155	オ 171	サ 187	ビ 203	ロ 219	♣ 235	町 251
C	1100	■ 140	┘ 156	ヤ 172	シ 188	フ 204	ワ 220	● 236	村 252
D	1101	■ 141	、 157	ユ 173	ス 189	ヘ 205	ン 221	○ 237	人 253
E	1110	■ 142	、 158	ヨ 174	セ 190	ホ 206	、 222	／ 238	罫 254
F	1111	＋ 143	、 159	ッ 175	ソ 191	マ 207	。 223	＼ 239	SP 255

# CONFIDENTIAL

Page 2 (PC850: Multilingual)

	HEX	8	9	A	B	C	D	E	F
HEX	BIN	1000	1001	1010	1011	1100	1101	1110	1111
0	0000	Ç 128	É 144	á 160	⌘ 176	Ⓕ 192	ø 208	Ó 224	— 240
1	0001	ü 129	æ 145	í 161	⌘ 177	Ⓕ 193	Ð 209	ß 225	± 241
2	0010	é 130	Æ 146	ó 162	⌘ 178	Ⓕ 194	Ê 210	ô 226	= 242
3	0011	â 131	ô 147	ú 163	 179	† 195	Ë 211	ò 227	$\frac{3}{4}$ 243
4	0100	ä 132	ö 148	ñ 164	† 180	— 196	È 212	õ 228	¶ 244
5	0101	à 133	ò 149	Ñ 165	À 181	† 197	ı 213	Ö 229	§ 245
6	0110	å 134	û 150	à 166	Ā 182	ã 198	í 214	µ 230	÷ 246
7	0111	ç 135	ù 151	ó 167	À 183	Ā 199	î 215	þ 231	ˆ 247
8	1000	ê 136	ÿ 152	¿ 168	© 184	Ⓕ 200	ï 216	þ 232	° 248
9	1001	ë 137	ö 153	® 169	¶ 185	Ⓕ 201	ƒ 217	Ů 233	˙ 249
A	1010	è 138	Û 154	¬ 170	 186	Ⓕ 202	ƒ 218	Ů 234	· 250
B	1011	ï 139	ø 155	$\frac{1}{2}$ 171	¶ 187	Ⓕ 203	■ 219	Ů 235	<sup>1</sup> 251
C	1100	î 140	£ 156	$\frac{1}{4}$ 172	¶ 188	† 204	■ 220	ý 236	<sup>3</sup> 252
D	1101	ì 141	Ø 157	ı 173	ϕ 189	= 205	ı 221	Ÿ 237	<sup>2</sup> 253
E	1110	Ä 142	× 158	« 174	¥ 190	† 206	î 222	— 238	■ 254
F	1111	Å 143	f 159	» 175	⌘ 191	Ⓕ 207	■ 223	' 239	SP 255

	HEX	8	9	A	B	C	D	E	F
HEX	BIN	1000	1001	1010	1011	1100	1101	1110	1111
0	0000	Ç 128	É 144	á 160	☐ 176	Ł 192	⌚ 208	α 224	≡ 240
1	0001	ü 129	À 145	í 161	☐ 177	⊥ 193	⸮ 209	β 225	± 241
2	0010	é 130	È 146	ó 162	☐ 178	⸮ 194	⸮ 210	Γ 226	≥ 242
3	0011	ã 131	ô 147	ú 163	 179	† 195	⌚ 211	π 227	≤ 243
4	0100	ã 132	õ 148	ñ 164	† 180	— 196	⌚ 212	Σ 228	ƒ 244
5	0101	à 133	ò 149	Ñ 165	† 181	† 197	⸮ 213	σ 229	∫ 245
6	0110	Á 134	Ú 150	ä 166	† 182	† 198	⸮ 214	μ 230	÷ 246
7	0111	ç 135	ù 151	ó 167	† 183	† 199	† 215	τ 231	≈ 247
8	1000	ê 136	î 152	ô 168	† 184	⌚ 200	† 216	Φ 232	° 248
9	1001	Ê 137	Ï 153	ò 169	† 185	⸮ 201	⌚ 217	θ 233	• 249
A	1010	è 138	Û 154	¬ 170	 186	⌚ 202	⸮ 218	Ω 234	· 250
B	1011	í 139	φ 155	½ 171	† 187	⸮ 203	■ 219	δ 235	√ 251
C	1100	Ô 140	£ 156	¼ 172	† 188	† 204	■ 220	∞ 236	n 252
D	1101	ì 141	Û 157	ì 173	† 189	= 205	■ 221	∅ 237	² 253
E	1110	Ã 142	Ⓐ 158	« 174	† 190	† 206	■ 222	ε 238	■ 254
F	1111	Ã 143	Ó 159	» 175	† 191	⌚ 207	■ 223	∩ 239	SP 255

# CONFIDENTIAL

Page 4 (PC863: Canadian-French)

	HEX	8	9	A	B	C	D	E	F
HEX	BIN	1000	1001	1010	1011	1100	1101	1110	1111
0	0000	Ç 128	É 144	Ï 160	Ï 176	Ł 192	Ł 208	α 224	≡ 240
1	0001	ü 129	È 145	Ï 161	Ï 177	Ł 193	Ŧ 209	β 225	± 241
2	0010	é 130	Ê 146	ó 162	Ï 178	Ŧ 194	Ŧ 210	Γ 226	≥ 242
3	0011	â 131	ô 147	ú 163	Ï 179	Ŧ 195	Ł 211	π 227	≤ 243
4	0100	Â 132	Ë 148	Ï 164	Ï 180	— 196	Ł 212	Σ 228	ƒ 244
5	0101	à 133	Ï 149	Ï 165	Ï 181	† 197	Ŧ 213	σ 229	∫ 245
6	0110	¶ 134	û 150	Ï 166	Ï 182	Ŧ 198	Ŧ 214	μ 230	÷ 246
7	0111	ç 135	ù 151	Ï 167	Ï 183	Ŧ 199	Ŧ 215	τ 231	≈ 247
8	1000	ê 136	œ 152	Ï 168	Ï 184	Ł 200	Ŧ 216	φ 232	° 248
9	1001	ë 137	ô 153	Ï 169	Ï 185	Ŧ 201	Ŧ 217	θ 233	• 249
A	1010	è 138	Û 154	Ï 170	Ï 186	Ł 202	Ŧ 218	Ω 234	· 250
B	1011	ï 139	φ 155	½ 171	Ï 187	Ŧ 203	■ 219	δ 235	√ 251
C	1100	î 140	£ 156	¼ 172	Ï 188	Ŧ 204	■ 220	∞ 236	n 252
D	1101	— 141	Û 157	¾ 173	Ï 189	— 205	■ 221	∅ <sup>2</sup> 237	² 253
E	1110	À 142	Û 158	« 174	Ï 190	Ŧ 206	■ 222	ε 238	■ 254
F	1111	§ 143	ƒ 159	» 175	Ï 191	Ł 207	■ 223	∩ 239	SP 255

	HEX	8	9	A	B	C	D	E	F
HEX	BIN	1000	1001	1010	1011	1100	1101	1110	1111
0	0000	Ç 128	É 144	á 160	☐ 176	Ł 192	ł 208	α 224	≡ 240
1	0001	ü 129	æ 145	í 161	☐ 177	± 193	ƒ 209	β 225	± 241
2	0010	é 130	Æ 146	ó 162	☐ 178	ƒ 194	ƒ 210	Γ 226	≥ 242
3	0011	â 131	ô 147	ú 163	 179	† 195	Ł 211	π 227	≤ 243
4	0100	ä 132	ö 148	ñ 164	† 180	– 196	Ł 212	Σ 228	ƒ 244
5	0101	à 133	ò 149	Ñ 165	‡ 181	† 197	ƒ 213	σ 229	ƒ 245
6	0110	å 134	û 150	ä 166	‡ 182	† 198	ƒ 214	μ 230	÷ 246
7	0111	ç 135	ù 151	ó 167	ƒ 183	† 199	† 215	τ 231	≈ 247
8	1000	ê 136	ÿ 152	ı 168	ƒ 184	Ł 200	† 216	Φ 232	° 248
9	1001	ë 137	Ö 153	ƒ 169	‡ 185	ƒ 201	ƒ 217	θ 233	• 249
A	1010	è 138	Ü 154	ƒ 170	 186	± 202	ƒ 218	Ω 234	• 250
B	1011	ï 139	ø 155	½ 171	ƒ 187	ƒ 203	■ 219	δ 235	√ 251
C	1100	î 140	£ 156	¼ 172	ƒ 188	† 204	■ 220	∞ 236	∞ 252
D	1101	ì 141	Ø 157	ı 173	ƒ 189	= 205	■ 221	∅ 237	² 253
E	1110	Ä 142	Pt 158	« 174	ƒ 190	† 206	■ 222	€ 238	■ 254
F	1111	Å 143	f 159	œ 175	ƒ 191	± 207	■ 223	∩ 239	SP 255

	HEX	8	9	A	B	C	D	E	F
HEX	BIN	1000	1001	1010	1011	1100	1101	1110	1111
0	0000	礎 128	本 144	SP 160	一 176	た 192	み 208		
1	0001	129	145	。 161	あ 177	ち 193	む 209	過 225	換 240
2	0010	除 130	荷 146	「 162	い 178	つ 194	め 210		
3	0011	131	147	」 163	う 179	て 195	も 211	足 226	攻 242
4	0100	定 132	特 148	、 164	え 180	と 196	や 212		
5	0101	133	149	・ 165	お 181	な 197	ゆ 213	利 228	産 244
6	0110	信 134	越 150	を 166	か 182	に 198	よ 214		
7	0111	135	151	あ 167	き 183	ぬ 199	ら 215	用 230	打 246
8	1000	緑 136	他 152	い 168	く 184	ね 200	り 216		
9	1001	137	153	う 169	け 185	の 201	る 217	移 232	納 248
A	1010	科 138	社 154	え 170	こ 186	は 202	れ 218		
B	1011	139	155	お 171	さ 187	ひ 203	ろ 219	下 234	変 250
C	1100	目 140	瓶 156	や 172	し 188	ふ 204	わ 220		
D	1101	141	157	ゆ 173	す 189	へ 205	ん 221	加 236	誂 252
E	1110	々 142	奉 158	よ 174	せ 190	ほ 206	ゝ 222		
F	1111	143	159	つ 175	そ 191	ま 207	ゝ 223	解 238	件 254



# CONFIDENTIAL

## Page 7 (One-pass printing Kanji characters)

















































	HEX	8	9	A	B	C	D	E	F
HEX	BIN	1000	1001	1010	1011	1100	1101	1110	1111
0	0000	日 128	会 144	水 160	受 176	点 192	課 208	買 224	非 240
1	0001	129	145	161	177	193	209	225	241
2	0010	扱 130	客 146	木 162	前 178	中 194	証 210	号 226	承 242
3	0011	131	147	163	179	195	211	227	243
4	0100	外 132	券 148	土 164	残 180	内 196	組 212	有 228	送 244
5	0101	133	149	165	181	197	213	229	245
6	0110	額 134	回 150	振 166	止 182	部 198	店 214	期 230	一 246
7	0111	135	151	167	183	199	215	231	247
8	1000	割 136	在 152	数 168	純 184	別 200	認 216	限 232	棄 248
9	1001	137	153	169	185	201	217	233	249
A	1010	検 138	算 154	精 170	替 186	戻 202	廃 218	頭 234	累 250
B	1011	139	155	171	187	203	219	235	251
C	1100	高 140	上 156	銭 172	代 188	門 204	両 220	差 236	違 252
D	1101	141	157	173	189	205	221	237	253
E	1110	価 142	火 158	総 174	値 190	料 206	効 222	括 238	番 254
F	1111	143	159	175	191	207	223	239	255

# CONFIDENTIAL

## Page 8 (One-pass printing Kanji characters)

	HEX	8	9	A	B	C	D	E	F
HEX	BIN	1000	1001	1010	1011	1100	1101	1110	1111
0	0000	訂 128	計 144	払 160	売 176	名 192	次 208	万 224	室 240
1	0001	129	145	161	177	193	209	225	241
2	0010	正 130	小 146	掛 162	取 178	個 194	不 210	責 226	商 242
3	0011	131	147	163	179	195	211	227	243
4	0100	品 132	金 148	入 164	係 180	領 196	枚 212	終 228	人 244
5	0101	133	149	165	181	197	213	229	245
6	0110	円 134	現 150	貸 166	未 182	収 198	誤 214	了 230	大 246
7	0111	135	151	167	183	199	215	231	247
8	1000	種 136	釣 152	出 168	消 184	予 200	休 216	免 232	安 248
9	1001	137	153	169	185	201	217	233	249
A	1010	担 138	預 154	支 170	費 186	約 202	契 218	伝 234	仕 250
B	1011	139	155	171	187	203	219	235	251
C	1100	当 140	税 156	単 172	年 188	込 204	開 220	自 236	控 252
D	1101	141	157	173	189	205	221	237	253
E	1110	合 142	引 158	返 174	月 190	明 206	閉 222	設 238	基 254
F	1111	143	159	175	191	207	223	239	255

	HEX	8	9	A	B	C	D	E	F
HEX	BIN	1000	1001	1010	1011	1100	1101	1110	1111
0	0000	€ 128	SP 144	SP 160	° 176	À 192	Ɔ 208	à 224	ö 240
1	0001	SP 129	‘ 145	ı 161	± 177	Á 193	Ñ 209	á 225	ñ 241
2	0010	, 130	, 146	¢ 162	² 178	Â 194	Ò 210	â 226	ò 242
3	0011	f 131	“ 147	£ 163	³ 179	Ã 195	Ó 211	ã 227	ó 243
4	0100	” 132	” 148	¤ 164	´ 180	Ä 196	Ô 212	ä 228	ô 244
5	0101	… 133	· 149	¥ 165	µ 181	Å 197	Õ 213	å 229	õ 245
6	0110	† 134	— 150	¦ 166	¶ 182	Æ 198	Ö 214	æ 230	ö 246
7	0111	‡ 135	— 151	§ 167	· 183	Ç 199	× 215	ç 231	+ 247
8	1000	^ 136	~ 152	¨ 168	˘ 184	È 200	Ø 216	è 232	ø 248
9	1001	‰ 137	™ 153	© 169	¹ 185	É 201	Ù 217	é 233	ù 249
A	1010	š 138	š 154	ª 170	º 186	Ê 202	Ú 218	ê 234	ú 250
B	1011	‹ 139	› 155	« 171	» 187	Ë 203	Û 219	ë 235	û 251
C	1100	Œ 140	œ 156	¬ 172	¼ <sup>1</sup> 188	Ì 204	Ü 220	ì 236	ü 252
D	1101	SP 141	SP 157	– 173	½ <sup>1,2</sup> 189	Í 205	Ý 221	í 237	ý 253
E	1110	ž 142	ž 158	® 174	¾ <sup>3,4</sup> 190	Î 206	Þ 222	î 238	þ 254
F	1111	SP 143	ÿ 159	— 175	¿ 191	Ï 207	ß 223	ï 239	ÿ 255

	HEX	8	9	A	B	C	D	E	F
HEX	BIN	1000	1001	1010	1011	1100	1101	1110	1111
0	0000	А 128	Р 144	а 160	 176	 192	 208	р 224	ѐ 240
1	0001	Б 129	С 145	б 161	 177	 193	 209	с 225	ё 241
2	0010	В 130	Т 146	в 162	 178	 194	 210	т 226	ѓ 242
3	0011	Г 131	У 147	г 163	 179	 195	 211	у 227	є 243
4	0100	Д 132	Ф 148	д 164	 180	 196	 212	ф 228	ї 244
5	0101	Е 133	Х 149	е 165	 181	 197	 213	х 229	і 245
6	0110	Ж 134	Ц 150	ж 166	 182	 198	 214	ц 230	ѕ 246
7	0111	З 135	Ч 151	з 167	 183	 199	 215	ч 231	і 247
8	1000	И 136	Ш 152	и 168	 184	 200	 216	ш 232	° 248
9	1001	Й 137	Щ 153	й 169	 185	 201	 217	щ 233	• 249
A	1010	К 138	Ъ 154	к 170	 186	 202	 218	ъ 234	· 250
B	1011	Л 139	Ы 155	л 171	 187	 203	 219	ы 235	√ 251
C	1100	М 140	Ь 156	м 172	 188	 204	 220	ь 236	N² 252
D	1101	Н 141	Э 157	н 173	 189	 205	 221	э 237	¤ 253
E	1110	О 142	Ю 158	о 174	 190	 206	 222	ю 238	 254
F	1111	П 143	Я 159	п 175	 191	 207	 223	я 239	SP 255

	HEX	8	9	A	B	C	D	E	F
HEX	BIN	1000	1001	1010	1011	1100	1101	1110	1111
0	0000	Ç <sub>128</sub>	É <sub>144</sub>	á <sub>160</sub>	☐ <sub>176</sub>	☐ <sub>192</sub>	d <sub>208</sub>	Ó <sub>224</sub>	- <sub>240</sub>
1	0001	ü <sub>129</sub>	Ł <sub>145</sub>	í <sub>161</sub>	■ <sub>177</sub>	☐ <sub>193</sub>	Đ <sub>209</sub>	ß <sub>225</sub>	" <sub>241</sub>
2	0010	é <sub>130</sub>	Í <sub>146</sub>	ó <sub>162</sub>	■ <sub>178</sub>	☐ <sub>194</sub>	Ď <sub>210</sub>	Ô <sub>226</sub>	‘ <sub>242</sub>
3	0011	â <sub>131</sub>	ô <sub>147</sub>	ú <sub>163</sub>	☐ <sub>179</sub>	☐ <sub>195</sub>	Ě <sub>211</sub>	Ň <sub>227</sub>	˘ <sub>243</sub>
4	0100	ä <sub>132</sub>	ö <sub>148</sub>	À <sub>164</sub>	☐ <sub>180</sub>	☐ <sub>196</sub>	ď <sub>212</sub>	ń <sub>228</sub>	˘ <sub>244</sub>
5	0101	û <sub>133</sub>	Ľ <sub>149</sub>	ą <sub>165</sub>	Á <sub>181</sub>	☐ <sub>197</sub>	Ń <sub>213</sub>	ň <sub>229</sub>	§ <sub>245</sub>
6	0110	ć <sub>134</sub>	ĭ <sub>150</sub>	Ž <sub>166</sub>	Â <sub>182</sub>	Ă <sub>198</sub>	í <sub>214</sub>	š <sub>230</sub>	÷ <sub>246</sub>
7	0111	ç <sub>135</sub>	Ś <sub>151</sub>	ž <sub>167</sub>	Ě <sub>183</sub>	ă <sub>199</sub>	î <sub>215</sub>	š <sub>231</sub>	’ <sub>247</sub>
8	1000	ì <sub>136</sub>	ś <sub>152</sub>	Ę <sub>168</sub>	Ş <sub>184</sub>	☐ <sub>200</sub>	ě <sub>216</sub>	Ŕ <sub>232</sub>	° <sub>248</sub>
9	1001	ë <sub>137</sub>	Ö <sub>153</sub>	e <sub>169</sub>	☐ <sub>185</sub>	☐ <sub>201</sub>	☐ <sub>217</sub>	Ú <sub>233</sub>	¨ <sub>249</sub>
A	1010	Ö <sub>138</sub>	Ü <sub>154</sub>	☐ <sub>170</sub>	☐ <sub>186</sub>	☐ <sub>202</sub>	☐ <sub>218</sub>	ú <sub>234</sub>	· <sub>250</sub>
B	1011	ö <sub>139</sub>	Ť <sub>155</sub>	ž <sub>171</sub>	☐ <sub>187</sub>	☐ <sub>203</sub>	■ <sub>219</sub>	Ů <sub>235</sub>	û <sub>251</sub>
C	1100	î <sub>140</sub>	ť <sub>156</sub>	Č <sub>172</sub>	☐ <sub>188</sub>	☐ <sub>204</sub>	■ <sub>220</sub>	ý <sub>236</sub>	Ř <sub>252</sub>
D	1101	Ž <sub>141</sub>	Ł <sub>157</sub>	ş <sub>173</sub>	Ž <sub>189</sub>	☐ <sub>205</sub>	Ŧ <sub>221</sub>	Ý <sub>237</sub>	ř <sub>253</sub>
E	1110	Ä <sub>142</sub>	× <sub>158</sub>	« <sub>174</sub>	ž <sub>190</sub>	☐ <sub>206</sub>	Ű <sub>222</sub>	ı <sub>238</sub>	■ <sub>254</sub>
F	1111	Ć <sub>143</sub>	č <sub>159</sub>	» <sub>175</sub>	☐ <sub>191</sub>	☐ <sub>207</sub>	■ <sub>223</sub>	’ <sub>239</sub>	SP <sub>255</sub>

	HEX	8	9	A	B	C	D	E	F
HEX	BIN	1000	1001	1010	1011	1100	1101	1110	1111
0	0000	Ç 128	É 144	á 160	⌘ 176	⌘ 192	ö 208	Ó 224	— 240
1	0001	ü 129	æ 145	í 161	⌘ 177	⌘ 193	Ð 209	ß 225	± 241
2	0010	é 130	Æ 146	ó 162	⌘ 178	⌘ 194	Ê 210	Ô 226	= 242
3	0011	â 131	ô 147	ú 163	 179	⌘ 195	Ë 211	Ò 227	<sup>3</sup> / <sub>4</sub> 243
4	0100	ä 132	ö 148	ñ 164	⌘ 180	— 196	È 212	õ 228	¶ 244
5	0101	à 133	ò 149	Ñ 165	Á 181	⌘ 197	€ 213	Õ 229	§ 245
6	0110	å 134	û 150	á 166	Â 182	ã 198	í 214	μ 230	÷ 246
7	0111	ç 135	ù 151	ó 167	À 183	Ã 199	î 215	þ 231	· 247
8	1000	ê 136	ÿ 152	¿ 168	© 184	⌘ 200	Ï 216	ð 232	° 248
9	1001	ë 137	Ï 153	® 169	⌘ 185	⌘ 201	⌘ 217	Ú 233	“ 249
A	1010	è 138	Û 154	¬ 170	 186	⌘ 202	⌘ 218	Û 234	· 250
B	1011	ï 139	ø 155	<sup>1</sup> / <sub>2</sub> 171	⌘ 187	⌘ 203	■ 219	Ù 235	<sup>1</sup> 251
C	1100	î 140	£ 156	<sup>1</sup> / <sub>4</sub> 172	⌘ 188	⌘ 204	■ 220	Ý 236	<sup>3</sup> 252
D	1101	ì 141	Ø 157	¡ 173	¢ 189	= 205	¡ 221	Ý 237	<sup>2</sup> 253
E	1110	Ä 142	× 158	« 174	¥ 190	⌘ 206	ì 222	— 238	■ 254
F	1111	Å 143	f 159	» 175	⌘ 191	⌘ 207	■ 223	’ 239	SP 255

## USING THE CHARACTER CODE TABLES

The example below uses Page 0 (PC437) to illustrate the use of the character code tables.

You can find the character "A" in Page 0 as follows:

The decimal value for the character "A" is 65.

Follow its column straight up to find the digits.

Hexadecimal . . . . . 4

Binary . . . . . 0100

These numbers are the most significant bits of the ASCII code.

Follow its row to the left to find the digits.

Hexadecimal . . . . . 1

Binary . . . . . 0001

These numbers are the least significant bits of the ASCII code.

The combination of the numbers above is the ASCII code for character "A".

Decimal . . . . . 65

Hexadecimal . . . . . 41

Binary . . . . . 01000001

## USING BIT VALUE TABLES

For each command that has a complex method of determining the variable **n**, there is a table showing how to calculate the variable in three numbering systems: binary, hexadecimal, and decimal.

When you look at the table, first find the value of each component of the variable. Then add the values of the components together to determine the value of the variable **n**.

For example, here is how you would use the table on the next page, which selects the print mode, to combine double-height, double-width, and underline. In the table, you see that bit 4 on (or hex 10 or decimal 16) turns on double-height, bit 5 on (or hex 20 or decimal 32) turns on double-width, and bit 7 on (or hex 80 or decimal 128) turns on underline mode.

To combine all three, turn on bits 4, 5, and 7, which is 10110000 in binary. Or you can add the hex values 10, 20, and 80 for the hex sum of B0, or you can add the decimal values 16, 32, and 128 for the decimal value of 176.

Therefore, you send the following to turn on double-height, double-width, and underline, depending on the numbering system used:

ASCII	ESC	!	<b>n</b>
Hex	1B	21	B0
Decimal	28	33	176



Bit	Off/On	Hex	Decimal	Function
0	Off	00	0	Character Font A selected.
	On	01	1	Character Font B selected.
1, 2	—	—	—	Undefined.
3	Off	00	0	Emphasized mode not selected.
	On	08	8	Emphasized mode selected.
4	Off	00	0	Double-height mode not selected.
	On	10	16	Double-height mode selected.
5	Off	00	0	Double-width mode not selected.
	On	20	32	Double-width mode selected.
6	—	—	—	Undefined.
7	Off	00	0	Underline mode not selected.
	On	80	128	Underline mode selected.

Binary, decimal, and hexadecimal numbers all have the same printing results.